

GENERAL INFORMATION

	Page
TERMS & CONDITIONS	2
GENERAL INFORMATION	4
ORDERING INFORMATION	5
SMARTKEY	18

BOX PACK

		Page
WEISER	Handlesets	30
	Levers	36
	Knobs	41
	Deadbolts	43
	Pocket Doorlocks	47
	Specifications	49
ELEMENTS	Handlesets	54
	Levers	56
	Knobs	59
	Deadbolts	60
	Specifications	62
SAFELOCK	Levers	66
	Knobs	68
	Deadbolts	69
	Specifications	71

VISUAL PACK

		Page
ELECTRONICS	Halo Touch	22
	Halo	22
	Aura	22
	SmartCode 10 Commercial Lever	22
	SmartCode 10 Residential Lever	23
	Smartcode Traditional Touchpad	23
	Smartcode Contemporary Touchpad	23
	Smartcode Traditional Keypad	23
	Smartcode Contemporary Keypad	24

Effective March 4, 2024
Updated March 2024



Scan here for the latest copy of this document. Available on weiserlock.com.

VISUAL PACK

		Page
ELECTRONICS	Powerbolt 3	24
	Elements Contemporary Keypad	24
	Elements Traditional Keypad	24
	SmartCode Handlesets	25
	Specifications	26
	WEISER	Handlesets
	Levers	80
	Knobs	83
	Deadbolts	85
	Combo Packs	87
	Pocket Doorlocks	88
ELEMENTS	Handlesets	90
	Levers	92
	Knobs	94
	Deadbolt	95
	Combo Packs	96
SAFELOCK	Handleset	100
	Levers	101
	Knobs	104
	Deadbolts	105
	Combo Packs	105

PARTS & ACCESSORIES

	Page
PARTS & ACCESSORIES	108

TERMS AND CONDITIONS OF SALE

Terms of payment – Net 30 days following date of invoice. Weiser® reserves the right to charge and recover on invoices which are not paid within the above terms, a service charge of 1-1/2% a month for each month or fraction thereof during which the invoice remains unpaid, said service charge, however, not to exceed the highest applicable legal rate of interest. All orders, whether solicited or written by our sales representatives or forwarded by our customers are deemed to be mere offers to purchase in accordance with these Terms and Conditions of Sale until actually accepted by us at our home office. We reserve the right to refuse any order as well as the right to sell or not sell to any firm at our sole discretion. The acceptance of an order is expressly made conditional upon your assent to these Terms and Conditions of Sale. We object to the inclusion of any different or additional terms or conditions, even if the same are included in your order, a contract of sale will result upon the Terms and Conditions of Sale stated herein only.

PRICES

All prices are subject to change without notice and are not guaranteed. All taxes, duties or other charges are the responsibility of the customer.

CLAIMS

Price or shortage claims must be submitted in writing to Spectrum Brands 3001 Deming Way, Middleton WI, 53562 within 30 days from the date of invoice.

CHANGES OR CANCELLATIONS

The goods purchased hereunder shall be and remain the property of Weiser until the purchase price has been paid in full by the purchaser.

CHANGES, CANCELLATIONS AND RETURNS

Beyond 2 working days of our acknowledgement date no changes can be made. Additions to an order will be handled as a separate order and must meet applicable minimum order requirements. Order cancellation on regular stock items only, or any portion thereof is allowed only upon prior written consent from Weiser, and the payment of cancellation charges deemed appropriate.

MINIMUM CHARGE

No order will be invoiced for less than \$100.00 net plus shipping charges except for lock accessory parts.

MINIMUM ANNUAL SALES VOLUME

The company reserves the right to discontinue direct sales to any customer who does not meet the minimum annual sales volume requirement. The current annual requirement is \$50,000.00. Your annual purchases are determined by accepted, noncancelled, and shipped orders received during each calendar year. Weiser reserves the right to change any or all minimum annual sales volume requirements at any time. Any customer who does not meet the annual sales volume requirements may continue to purchase Weiser products through a Weiser distributor.

RETURNS

Defective merchandise returned to our distribution centres requires prior written authorization from a Weiser Sales Rep or the Sales Office. A return goods authorization number must accompany the returned shipment. The return authorization must include an itemized listing of the merchandise and an explanation stating the reason for return. There will be a 20% product restocking fee on all returned merchandise.

FREIGHT

All goods are invoiced FOB to our warehouse. Upon delivery of shipments to the carrier, title to, and the risk of loss or damage in transit for such shipments, passes to our customer.

Weiser's standard policy is to pay freight charges on all orders to a single destination in Canada by carrier and route of our choice. Weiser reserve the right to charge a \$25 handling charge for orders that do not meet the customer's minimum.

DELIVERY CONDITIONS

Shipping schedules are our best estimates, and cannot be guaranteed. Weiser is not responsible for any direct or consequential loss or damage resulting from an inability or delay in meeting shipping schedules.

PRODUCT WARRANTY

Warranties cover the original residential user of Weiser Products against defects in material and workmanship as long as the original user occupies the residential premises upon which the Product was originally installed. This warranty DOES NOT COVER abused or misused products or non-commercial products used in commercial applications. Upon return of a defective product to Weiser Corporation, Weiser shall either replace the product or refund the purchase price, at our discretion. If a covered defect occurs, call 1-800-501-9471 in Canada or return it to Weiser, 101-255 Longside Drive, Mississauga, ON L5W 0G1. A finish deterioration occurring from the use of paints, solvents, or other chemicals is not a defect in the finish and is not covered by this warranty. Weiser is not liable for incidental or consequential damages. Some do not allow the exclusion or limitation of incidental or consequential damages, so the above exclusion may not apply to you. This warranty gives you specific legal rights and you may also have other rights that vary from state to state.

PATENT INDEMNITY

We agree to defend any suit or proceeding brought against our customer so far as based on claim that our products, or any part thereof, made solely to our specifications and furnished to our customer constitute an infringement of any U.S. patent, if notified promptly in writing and given authority, information and assistance at our expense for the defense of same, and we shall pay all damages and costs awarded therein against our customer. In case our products, or any part thereof, is in such suit held to constitute infringement and their use is enjoined, we will, at our expense and discretion, either procure for our customer the right to continue using the products or replace same with non-infringing products, or modify them so they become noninfringing, or remove such products and refund the purchase price (less depreciation, prorated from the purchase date). The foregoing states our entire liability for patent infringement by our products or any part thereof.

INTELLECTUAL PROPERTY

No person or entity may sell, distribute, advertise, market or promote Weiser branded products distributed by Weiser, Spectrum Brands Hardware Home Improvement Division, without prior authorization from Weiser. Customers of Weiser who are authorized to sell Weiser branded products are referred to herein as “Customers.”

The Weiser brand and all Weiser trademarks, trade names, product depictions, colors, graphics or logos, whether or not registered or otherwise protected (the “Marks”), remain the sole and exclusive property of Weiser and nothing arising out of the relationship between Weiser and any Customer conveys to Customer any ownership rights in the Marks. Customer may use the Marks and then only in the sale or promotion of authentic Weiser products in compliance with the terms of this policy. The Marks must be used exactly in the form provided and in conformity with all Weiser trademark usage policies or guidelines, including, but not limited to, those relating to shape, color match and imprint quality. Any proposed deviation must be approved in writing by Weiser prior to use. The Marks may not be used in or as part of any Customer domain name on the Internet. Prior to any use of the Marks on goods or services, Customer must submit samples for Weiser’s approval.

Additionally, no Customer may use product depictions, graphics, logos or text relating to Weiser products that have not been provided by Weiser in connection with the advertising, promotion or sale of Weiser products without Weiser’s prior review and written approval of each such use. The Marks may not be used in or as part of any reseller or other third party (i) domain name or URL on the Internet, (ii) trademark or service mark, or (iii) company or trade name. Any action on the part of a Customer that violates the terms of this policy or otherwise impairs the value of or goodwill associated with the Marks or is otherwise not in conformity with Weiser’s standards may result in the suspension or termination of the Customer’s authorization or any other remedy permitted by law.

Weiser grants to each of its Customers limited, non-transferable, non-sublicenseable licenses of the patents relating to the Weiser products that the Customer is authorized to sell and of the copyrights in any packaging or other written materials included therewith or related thereto. Said patent and copyright licenses are solely to sell such Weiser products covered by such patents and to which such copyrights relate only to end-users and other Customers in compliance with the terms of this document. The sale of such patented Weiser products and the sale or use of such copyrighted materials by a Customer that violate the terms of this document exceed the scope of the licenses herein granted to the Customer and may constitute patent and/or copyright infringement.

STANDARDS

Weiser meets or exceeds the testing requirements specified for each product grade or rating.

- American National Standards Institute (ANSI)
- Builders Hardware Manufacturers Association (BHMA)
- Underwriters Laboratories, Inc. (UL)
- Americans with Disabilities Act (ADA)

MISCELLANEOUS

Substitution of non-Weiser components/parts, and any alteration or modification of factory parts, and other lock manufacturer’s parts may result in door hardware which does not function properly or will fail and will void all warranties. Orders not specified with keying requirements will be shipped Keyed Differently (KD). Orders with keying requirements of K10 or more must have a “Letter of Release” on file with Weiser stating that Weiser Corporation will not be held liable for cost and expense arising from any loss or damage to property utilizing Weiser products where 10 or more locks have been keyed alike. Contact your Sales Office account representative for a copy of the release form. Weiser reserves the right to revise or modify products, product information, or pricing without notice. Product specifications and pricing reflect available information at the time of printing. Weiser is not responsible for typographic or printing errors.

In the interest of personal security and safety, all locksets and latchset functions that may be used on exterior doors, will be shipped from the factory with deadlocking latches only. Orders received for these functions that indicate spring latches will be converted to deadlocking latches.

In the interest of personal security and safety, all locksets and latchset functions that may be used on exterior doors, will be shipped from the factory with deadlocking latches only. Orders received for these functions that indicate spring latches will be converted to deadlocking latches.

BACKSET

Backset is the distance from center edge of door to center of the 2-1/8" (54mm) diameter hole, 2-3/8" or 2-3/4" in most cases.

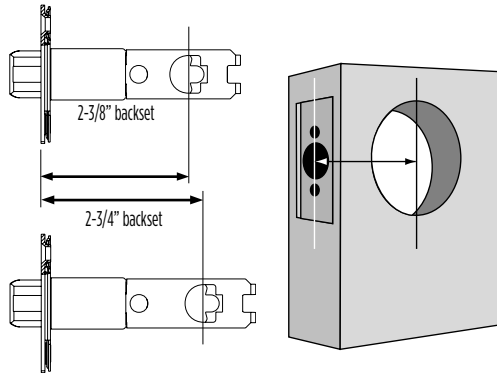

UNDERWRITERS LABORATORIES LISTED LOCKSETS

To meet Underwriters Laboratories' fire rating requirements UL listed locksets, UL listed latches, and UL listed strikes must be used together.



AMERICAN WITH DISABILITIES ACT

Please contact Weiser for products that comply with the Americans with Disabilities Act of 1990.



SERIES DESIGNATION CHOOSE FROM

	Series	Description
SAFELOCK	SK	Knobsets
	SL	Leversets
	SD	Deadbolts
	SH	Handlesets
ELECTRONIC DEADBOLTS ELEMENTS	GED	Electronics
	GAC	Knobset
	GAC/GLC	GAC - Knob, GLC - Lever Interior Packs
	GLC	Leversets
	GDC	Deadbolts
	GAC	Handlesets LIP
	GAC/GLC	Combo Pack
WEISER	GA	Knobset
	GA/GLA	GA - Knob, GLA - Lever Interior Packs
	GLA	Leversets
	GD/SSD/SDD/GCD	Deadbolts
	GA	Handlesets LIP
	GSC/GSL	Combo Pack

**** NEW simplified ordering process ** All Weiser & Safe Lock products are now ordered by part number**

NOTE: All box pack handlesets are ordered LESS INTERIOR PACK (LIP). Interior packs must be ordered separately

FUNCTION NUMBER

Model	Function
101/1000	Passage/Hall/Closet
331/3000	Privacy/Bed/Bath
531/535/5000	Keyed Entry
581	Storeroom/Vestibule
12/7000	Inactive Trim, Surface or Bolt through mounting
1030/1031	Pocket Door Lock
9771/1100/8771	Single Cylinder Handleset
9675/8675	Interior Pack for Weiser Handlesets
1471/9471/9100	Single Cylinder Deadbolts
9571	Key Control Deadbolts
9240/9250	Elements Keypad/Powerbolt3
9260/9270/2600/2700	SmartCode/SmartCode Lever
1850/2500/3000	Aura/Halo/Halo Touch
7451/7481/6000	Combo Packs

NOTE: All box pack handlesets are ordered LESS INTERIOR PACK (LIP). Interior packs must be ordered separately

ORDERING INFORMATION

STYLE

		Series	Description			Series	Description		
KNOBS & LEVERS	SAFELOCK	AS	Athens	KNOBS & LEVERS	WEISER	PGK	Prague (knob)		
		DAL	Dayton			PHL	Perth		
		GV	Grapevine			SEL	Sedona		
		LY	Layton			SAL	Singapore		
		RG	Regina			SYL	Sydney		
		REL	Reminy			TC	Toluca		
		WTL	Westley			TDL	Trafford		
		WI	Winston			T	Troy		
		ELEMENTS	AI			Alfini	HANDLESETS	SAFELOCK	BRN
	BLM		Belmont	DT	Daytona				
	B		Beverly	ELEMENTS	AMD	Amador			
	BRNL		Breton		BDH	Brentwood			
	CSL		Casey		HYH	Henley			
	F		Fairfax		KNH	Kingsway			
	HYL		Henley		WEISER	A			Augusta
	HSL		Hollis			HE			Hawthorne
	KML		Kim	H		Heritage			
	TSL		Tristan	PGH		Prague			
	Y	Yukon	PTH	Prescott					
WEISER	CBK	Cambie	SCE	San Clemente					
	D	Dane	TVH	Tavaris					
	HFL	Halifax	VNH	Vancouver					
	HT	Huntington							
	KAL	Katella							
	LSL	Lisbon							
	MIL	Milan							
	MRL	Montreal							
	P	Phoenix							
	PGL	Prague (lever)							

Intro

Electronics

Box Pack

Visual Pack

Parts

FINISH

Finish	Description	ANSI / BHMA
3	Polished Brass	605
3BR	Lifetime Polished Brass	605E
4	Satin Brass	-
5	Antique Brass	609
11P	Venetian Bronze	-
15	Satin Nickel	619
26	Polished Chrome	625
26D	Satin Chrome	626
514	Matte Black	-
9/32D	Bright Bronze/ Satin Chrome	-

KEYING

CHOOSE FROM

Code	Description
KD	Keyed Differently
K2, K3	Keyed Alike (2 Locksets, 3 Locksets)
MK	Master Keyed
CK	Builder (Construction) Keyed
CMK	Builder (Construction) Master Keyed
SMT	SmartKey
WS	Weiser Pin & Tumbler
KW	KW Pin & Tumbler

NOTE: SMT (SmartKey) is the default configuration for all Weiser products, excluding Safelock

PACKAGING

CHOOSE FROM

B Box Pack	MS Merchandiser Sensomatic	VS Visual Pack
-------------------	-----------------------------------	-----------------------

HANDING (LEVERS)

CHOOSE FROM

LH Left Hand	RH Right Hand
---------------------	----------------------

To determine the handing of a door face the OUTSIDE of the door. If the hinge is on the left side of the door, the door is left handed (LH). If the hinge is on the right side of the door, the door is right handed (RH).

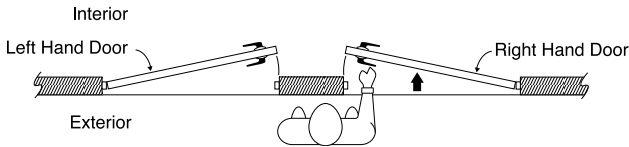

NOTE: Handing required for Inactive levers and handlesets with handed levers

FIRE RATINGS

IF REQUIRED:

Code	Description
UL	UL 3 Hour Rated Fire Door
FD	20 Minute Rated Fire Door (FD)

LATCH CONFIGURATION

CHOOSE FROM

Latch	Description
SL/SCAL	Square Corner Adjustable Latch
RL/RCAL	Radius Corner Adjustable Latch
DI/RFAL	Round Face Drive-in Latch
4L	4-Way Adjustable Latch
6L	6-Way Adjustable Latch

STRIKE CONFIGURATION

CHOOSE FROM

Code	Description
R1	Radius Cornered Strike (Interior/Exterior)
R2	Radius Cornered Strike (Deadbolts)
R3	1/4" (6.4mm) Radius Full Lip Deadbolt Strike
S1	Square Cornered Strike (Interior/Exterior)
S2	Square Cornered Strike (Deadbolts)
S3	Square Corner Full Lip Deadbolt Strike
S5	Square Cornered Strike (For Metal Frames)
T1	T-Strike (4-7/8" Length, ASA Strike)
T2	T-Strike (2-3/4", ANSI Strike), Exterior
T3	Square Corner T-Strike for Deadbolt
DS	Square and Radius Cornered Strike (Interior pack Only)

SPECIALITY KEYING ORDERING INFORMATION

CYLINDER OPTIONS

PRODUCT CODE	DESCRIPTION	HANDLESETS	DEADBOLTS	KNOBBS & LEVERS
SMT	5 pin SmartKey Re-Keying Technology with KWI Keyway Default	✓	✓	✓
WS	Weiser 5-pin Pin & Tumbler	Limited	Limited	Limited
KW	Kwikset 5-pin Pin & Tumbler	Limited	Limited	Limited

KEYING OPTIONS

KEYING	DESCRIPTION	SMT	WS	KW	ADDITIONAL CHARGE	NOTES	ORDERING EXAMPLE - CONFIRMATION NOMENCLATURE
KD	Keyed Different - Each lock is individually keyed to a different key cut	✓	✓	✓	No Charge	1 set of 2 keys cut the same (additional keys can be ordered through service parts program)	Qty 12 - 9SSD94710-023
KA	SmartKey Keyed Alike - All locks are keyed to same key cut number	✓			\$6.00	Only available with a given cylinder type, SMT keyway cannot be keyed alike to WS keyway. Included: 1 set of 2 keys cut to same number for entire series	Qty 12 - 9SSD94710-023 KA12
WITH	With - All locks across multiple lines are keyed to same key cut	✓	✓	✓	No Charge	Only available with a given cylinder type, SMT keyway cannot be keyed alike to WS keyway. Included: 1 set of 2 keys cut to same number for entire series	Qty 12 - 9SSD94710-023 WITH Qty 12 - 9SSD94710-023 KA2
KEY CODE	Customer selects the specific key cut that they would like the cylinder to be keyed to	✓	✓	✓	No Charge	Customer must specify the 5 digit code they would like the cylinders to be keyed to	Qty 12 - 9SSD94710-023 NOTES: KA12 TO: 45325
CK	Construction Keyed - Allows new homes to be keyed to a builder's key during construction. After homeowner uses their key, the builder key is rendered inoperable	✗	✓	✓	\$19.00	Only available with WS and KW keyways. Included: 5 Construction Keys and 1 set of 2 keys cut to same number for each lock	Qty 12 - 9SSD94710-052 CK
MK	Master Keyed - Allows multiple keys to operate a single lock. Often used in multi-family applications for owners and tenants.	✗	✓	✓	\$19.00	Only available with WS and KW keyways. Included: 5 Master Keys and 1 set of 2 keys cut to the same number for each lock	Qty 4 - 9SSD94710-052 MK
CMK	Construction Master Keyed - Allows multiple keys to operate a single lock, with the added functionality of a Construction Key. Often used in multi-family applications.	✗	✓	✓	\$23.00	Only available with WS and KW keyways. Included: 5 Master Keys, 5 Construction Keys and 1 set of 2 keys cut to same number for each lock	Qty 4 - 9SSD94710-052 CMK
XKEY	Orders will ship with no keys in product boxes. Often used in multi-family applications.	✓	✓	✓	No Charge	Keys will arrive in envelopes prior to product shipment.	Qty 12 - 9SSD94710-052 XKEY
TC/BC GCD9571 SMT	Key Control Deadbolt application: Top Cylinder (TC) = Master Cylinder Bottom Cylinder (BC) = Tenant Cylinder	✓	✗	✗	\$6.00	Only available with SMT keyways. Included: default 2-TC keys and 2 BC-keys. For KA options, see multi-family order example guide.	Qty 4 - 9GCD95710-033 NOTES: TC KA4 TO: 45325, BC KD
STAMPING	Keys are stamped to requested key code or key designation such as MK, CK, 2AA or DNC (Do Not Copy)	✗	✓	✓	No Charge	Only available with WS and KW keyways.	QTY 4 - 9SSD94710-052 CMK STAMPING NOTES PER REQUIREMENTS

Intro

Electronics

Box Pack

Visual Pack

Parts

LATCH OPTIONS

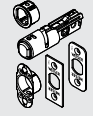
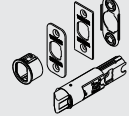
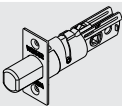
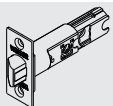
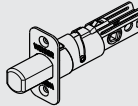
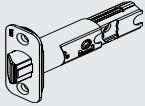
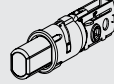
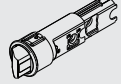
PRODUCT CODE	DESCRIPTION	DEADBOLTS	KNOBS & LEVERS
6L	Latch with kit including collar, back plate, and round and square fronts		
SL/*SCAL	Adjustable latch with Square-Corner Front		
RL/*RCAL	Adjustable latch with Radius-Corner Front		
DI/*RFAL	Adjustable latch with Drive-in Collar or Round Face		

STRIKE OPTIONS

PRODUCT CODE	DESCRIPTION	DEADBOLTS	KNOBS & LEVERS
S1 / S2 / *SCS	Square Corner strike: S1 = knob/lever, S2 = deadbolt, SCS = Safelock		
R1 / R2 / *RCS	Radius Corner Strike = R1 = knob/lever, R2 = deadbolt, RCS = Safelock		
T3 / T2	T Strike (Metal Door Frame Application)		
T6	ANSI ASA-1 Strike (Metal Door Frame Application)	N/A	
SS / *SS303	Two Hole Metal Door Deadbolt Strike		N/A

* Denotes Safelock descriptions

KEY TABLE

WS	TENANT	800000-125	800000-125
	MK	800004-342	N/A
	CK	800004-340	N/A
KW	TENANT	800004-353	800004-355
	MK	800004-355	N/A
	CK	800004-353	N/A
KEY CONTROL	TOP (TC)	820204-001	820231-001
	BOTTOM (BC)	800004-353	800004-355

KEYING ORDER SAMPLE EXAMPLES:

SMT KA - 1 LINE EXAMPLE	
96 - 9SSD94710-023 KA96 XKEY	
Order Notes:	10 - KA Keys (800004-353 K20 TO DEADBOLT LINE) 5 - RK Keys (800004-353 K10 RANDOM) 192 - TK Keys (800004-353 K4 RANDOM)
Sample Notes:	New project Smartkey, deadbolts are keyed alike to KA key - Used as construction key on site Requesting 20 Keyed Alike Keys - 20 keys that are cut the same and currently operate the locks Requesting 10 Realtor Keys - 10 keys that are cut the same but use a random bitting Requesting 384 Tenant Keys - 96 sets of K4 random bitting sets Requesting all deadbolts ship XKEY - Keys shipped in envelopes and not in individual boxes

* Two keys per ring, total quantity must be an even amount. Ordering instructions are 1/2 total amount.

SMT KA - 2 LINE EXAMPLE	
48 - 9SSD94710-023 KA48 XKEY	
24 - 9SSD94710-023 KA24 XKEY	
Order Notes:	LINE 1 - KEY ALL ALIKE LINE 2 - KEY ALL ALIKE TO LINE 1 5 - KA Keys (800004-353 K10 TO DEADBOLT LINE) 96 - TK Keys (800004-353 K4 RANDOM)
Sample Notes:	New project Smartkey, deadbolts are keyed alike to KA key - Used as construction key on site Requesting 10 Keyed Alike Keys - 10 keys that are cut the same and currently operate the locks Requesting 192 Tenant Keys - 48 sets of K4 random bitting sets Requesting all deadbolts ship XKEY - Keys shipped in envelopes and not in individual boxes

* Two keys per ring, total quantity must be an even amount. Ordering instructions are 1/2 total amount.

KEY CONTROL - 1 LINE EXAMPLE	
170 - 9GCD95710-033 KA170 XKEY	
Order Notes:	3 - TC Keys (820204-001 K6 TO TOP CYLINDER) 13 - BC Keys (800004-353 K26 TO BOTTOM CYLINDER) 5 - RK Keys (800004-353 K10 RANDOM) 340 - TK Keys (800004-353 K4 RANDOM)
Sample Notes:	New Key Control project- top cylinders are KA as the master key, bottom cylinders are KA which are used as construction keys on site Requesting 6 Top Cylinder Keys - 6 keys that are cut the same and currently operate the top cylinder of the locks Requesting 26 Bottom Cylinder Keys - 26 keys that are cut the same and currently operate the bottom cylinder of the locks Requesting 10 Realtor Keys - 10 keys that are cut the same but use a random bitting Requesting 680 Tenant Keys - 170 sets of K4 random bitting sets Requesting all deadbolts ship XKEY - Keys shipped in envelopes and not in individual boxes

* Two keys per ring, total quantity must be an even amount. Ordering instructions are 1/2 total amount.

Intro

Electronics

Box Pack

Visual Pack

Parts

KEYING ORDER SAMPLE EXAMPLES:

KEY CONTROL - 2 LINE EXAMPLE	
80 - 9GCD95710-033 KA80 XKEY	
80 - 9SSD94710-023 KA80 XKEY	
Order Notes:	LINE 1 - KEY ALL TOP CYLINDERS ALIKE TO ANY - KEY ALL BOTTOM CYLINDERS ALIKE TO ANY LINE 2 - KEY ALL ALIKE TO BOTTOM CYLINDER ON LINE 1 5 - TC Keys (820204-001 K10 TO TOP CYLINDER) 13 - BC Keys (800004-353 K26 TO BOTTOM CYLINDER) 160 - TK Keys (800004-353 K4 RANDOM)
Sample Notes:	New Key Control project- top cylinders are KA as the master key, bottom cylinders & SSD9471 cylinders are KA which are used as construction keys on site Requesting 10 Top Cylinder Keys - 10 keys that are cut the same and currently operate the top cylinder of the locks Requesting 26 Bottom Cylinder Keys - 26 keys that are cut the same and currently operate the bottom cylinder of the locks Requesting 320 Tenant Keys - 80 sets of K4 random biting sets Requesting all deadbolts ship XKEY - Keys shipped in envelopes and not in individual boxes

** Two keys per ring, total quantity must be an even amount. Ordering instructions are 1/2 total amount.*

WS CMK - EXAMPLE	
60 - 9SSD94710-052 CMK WITH	
60 - 9SSD94710-052 K2	
Order Notes:	5 - MK Keys (800004-342 K5) MK TO ANY 10 - CK Keys (800004-340 K10) CK TO ANY CMK LINE 1 ONLY
Sample Notes:	Construction Master Keyed project 60 units project - 2 deadbolts KA per unit (Suite entry door is CMK FD & deck door is KA to suite entry) Requesting 5 Master Keys Requesting 10 Construction Keys Requesting 60 sets of Tenant Keys, 4 keys per ring

**CK keys are ordered in singles, order amount required, default is 5.*

**MK keys have a default of 5 keys, however can be ordered in singles*

**Tenant keys do not need to be requested, default is two per lock*

**Keys arrive in individual boxes when ordered as (WS) / Keys arrive in envelopes when ordered as (XKEY)*

WS MK - 1 LINE EXAMPLE	
80 - 9SSD94710-052 MK KD	
Order Notes:	5 - MK Keys (800004-342 K5) MK TO ANY
Sample Notes:	Master Keyed, Keyed Different 80 units project - 1 deadbolt per unit Requesting 5 Master Keys

**MK keys have a default of 5 keys, however can be ordered in singles*

**Tenant keys do not need to be requested, default is two per lock*

**Keys arrive in individual boxes when ordered as (WS) / Keys arrive in envelopes when ordered as (XKEY)*



SMARTKEY SECURITY™

THE ONLY LOCK YOU CAN RE-KEY IN SECONDS!

What is SmartKey?

SmartKey™ is a technology that allows you to re-key a lock in just seconds while improving security without removing the lock from the door.

How Does it Work?

SmartKey™ has a patented side locking bar technology that replaces the traditional pin and tumbler design. This new design includes BumpGuard™ for improved security against lock-bumping, an attack technique that can defeat traditional pin and tumbler locks.

SUPERIOR SECURITY

It's why we buy locks in the first place. With SmartKey™ technology from Weiser you are guaranteed to have one of the most secure residential deadbolts on the market.

ANSI Graded Deadbolts

Deadbolt locks are rated by an independent agency (ANSI) on a grade scale; with Grade 3 being good, and Grade 1 being the best.

How does SmartKey rate?

All of our SmartKey deadbolts are ANSI rated and approved. In our Collections family of products, many of our SmartKey deadbolts are rated as Grade 1 - providing you with the very best residential security on the market and featuring the highest level of pick resistance available.

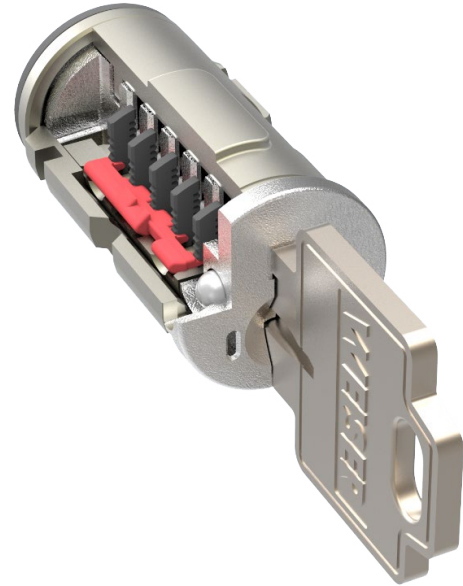

Available in All Weiser Keyed Functions

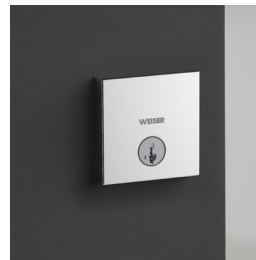

Deadbolts

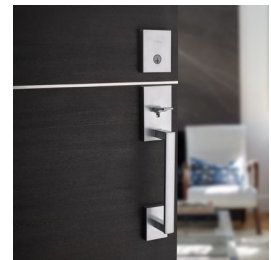

Handlesets

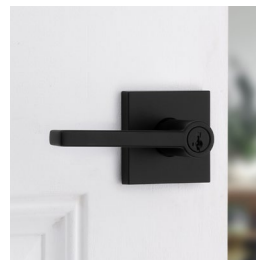

Levers

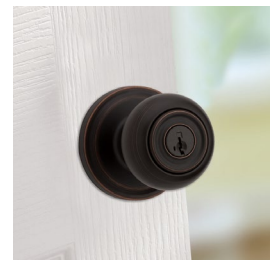

Knobs



BEFORE YOU START...

These steps show you how to change from the current key that operates the lock to a new key you want to operate the lock. For new purchases, the current key is the one that was supplied with the lockset.

Be sure to install the product on the door first, prior to rekeying.

These instructions illustrate a deadbolt for demonstration purposes, but these SmartKey rekeying instructions also apply to keyed knobs, levers, and handlesets.

DEFINITIONS

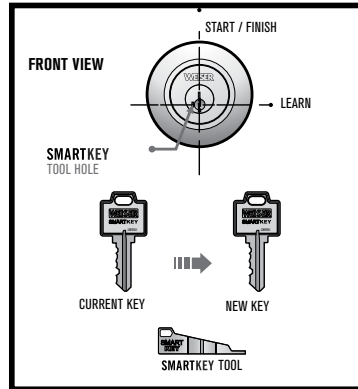

www.weiserlock.com/smartkey

STEP 1 TURN TO LEARN POSITION

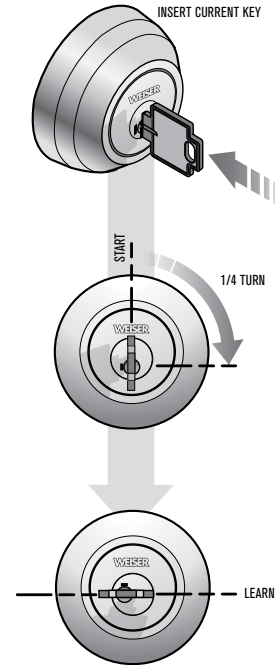

STEP 2 INSERT AND REMOVE SMART KEY TOOL

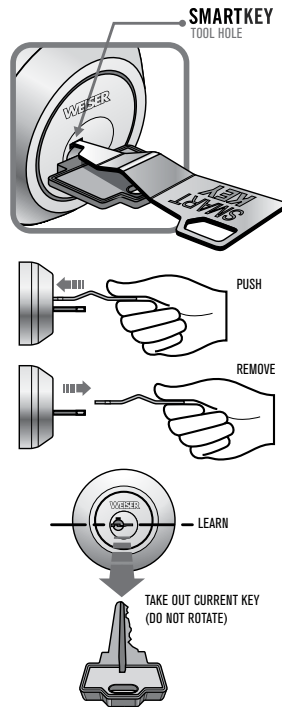

STEP 3 LEARN NEW KEY

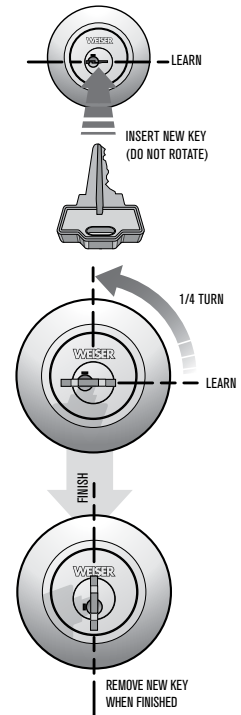

Intro

Electronics

Box Pack

Visual Pack

Parts



1

HALF TURN

A Before you begin, rotate lower dial to the right till it stops to align arrow on upper grip with start point ① on inner dial.



B Insert cylinder all the way into the inner dial.



C Rotate lower dial half turn to the left till it stops, where the two arrows meet.

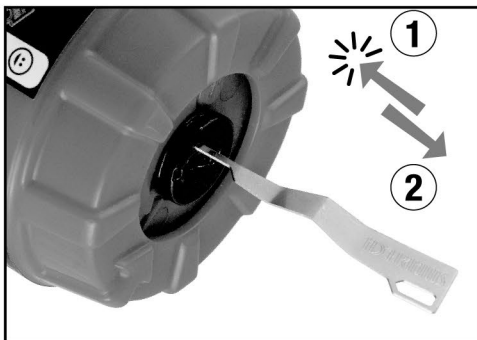

2

A Insert the SmartKey tool into the small hole (next to the keyway) on the cylinder face, and push with force till it goes all the way in, then remove the SmartKey tool.



B Insert the key you want to learn in the plug, while being sure not to rotate the plug

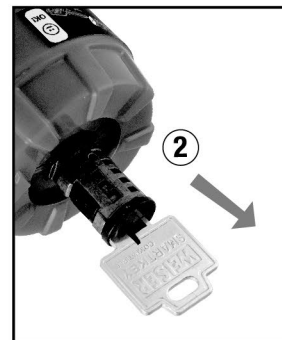

C Remove the plug from the reset cradle by gently pulling on the key.

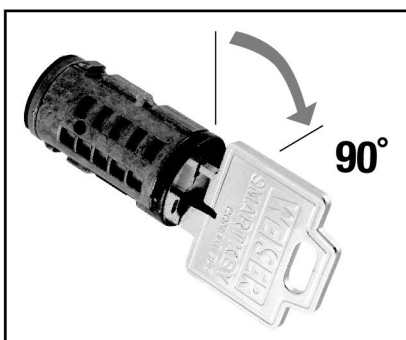

3

A While holding the cylinder body stationary, rotate the key back to the home position.

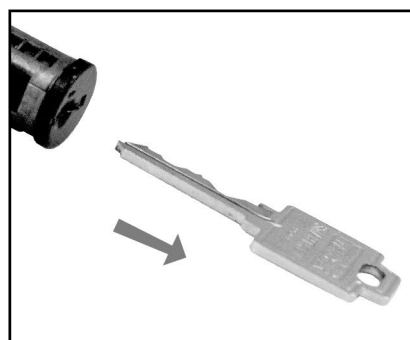

B Remove the key.



C Reinstall cylinder in product



ELECTRONICS



Intro

Electronics

Box Pack

Visual Pack

Parts

HALO TOUCH		Finish Availability	GED 3000
15	Satin Nickel		9GED30000-003
514	Matte Black		9GED30000-004
		List Price	\$630
		Case Quantity	1



HALO TOUCHSCREEN		Finish Availability	GED 2500
15	Satin Nickel		9GED25000-003
514	Matte Black		9GED25000-004
		List Price	\$570
		Case Quantity	1



AURA		Finish Availability	GED 1850
15	Satin Nickel		9GED18500-001
514	Matte Black		9GED18500-002
		List Price	\$414
		Case Quantity	1



SMARTCODE 10 COMMERCIAL LEVER		Finish Availability	GED 2600
15	Satin Nickel		9GED26000-001
514	Matte Black		9GED26000-002
		List Price	\$359
		Case Quantity	1



SMARTCODE 10 LEVER		Finish Availability	GED 2700
	15	Satin Nickel	9GED27000-001
	514	Matte Black	9GED27000-002
	List Price		\$352
	Case Quantity		1



SMARTCODE TRADITIONAL TOUCHPAD		Finish Availability	GED 9270
	15	Satin Nickel	9GED92700-001
	514	Matte Black	9GED92700-002
	List Price		\$320
	Case Quantity		2



SMARTCODE CONTEMPORARY TOUCHPAD		Finish Availability	GED 9270
	15	Satin Nickel	9GED92700-003
	514	Matte Black	9GED92700-004
	List Price		\$320
	Case Quantity		2



SMARTCODE TRADITIONAL KEYPAD		Finish Availability	GED 9260
	15	Satin Nickel	9GED92600-001
	514	Matte Black	9GED92600-002
	List Price		\$270
	Case Quantity		2



Intro

Electronics

Box Pack

Visual Pack

Parts

SMARTCODE CONTEMPORARY KEYPAD



Finish Availability		GED 9260
15	Satin Nickel	9GED92600-003
26D	Satin Chrome	9GED92600-005
514	Matte Black	9GED92600-004
List Price		\$270
Case Quantity		2



20 min.

POWERBOLT 3



Finish Availability		GED 9250
3	Brass	9GED92500-001
11P	Venetian Bronze	9GED92500-004
15	Satin Nickel	9GED92500-002
26D	Satin Chrome	9GED92500-003
514	Matte Black	9GED92500-005
List Price		\$205
Case Quantity		2



ELEMENTS CONTEMPORARY KEYPAD



Finish Availability		GED 9240
15	Satin Nickel	9GED92400-005
514	Matte Black	9GED92400-006
List Price		\$150
Case Quantity		2



ELEMENTS TRADITIONAL KEYPAD



Finish Availability		GED 9240
15	Satin Nickel	9GED92400-003
514	Matte Black	9GED92400-004
List Price		\$150
Case Quantity		2



Prescott x SmartCode Traditional Keypad		Finish Availability	GLA9260 TRL PTH/KAL
	15	Satin Nickel	9GLA92600-001
	514	Matte Black	9GLA92600-002
			
		Interior	Katella
		List Price	\$560
		Case Quantity	2

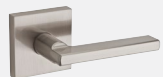

San Clemente x SmartCode Contemporary Keypad		Finish Availability	GLA9260 CNT SCE/HFL
	15	Satin Nickel	9GLA92600-003
	514	Matte Black	9GLA92600-004
			
		Interior	Halifax
		List Price	\$560
		Case Quantity	2



All Electronics product meets ASTM E 331 water penetration testing

HALO TOUCH

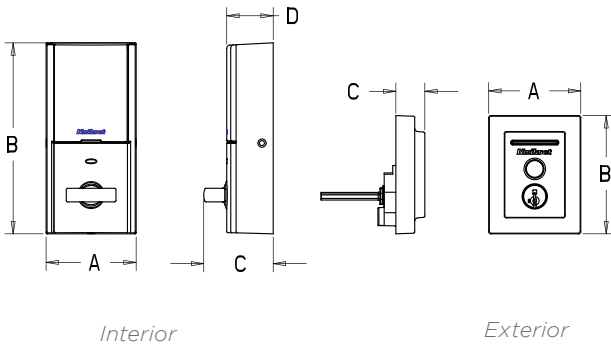

Design	A	B	C	D
Interior	2-23/32" (69 mm)	5-25/32" (147 mm)	2-2/32" (53 mm)	1-13/32" (36 mm)
Exterior	2-25/32" (71 mm)	3-9/16" (91 mm)	7/8" (22 mm)	---

Function	Single cylinder deadbolt
Door Prep	2 1/8" diameter bore hole & 1" diameter latch hole
Backset	Adjustable 2-3/8" or 2-3/4"
Door Thickness	1-3/4" - 2" automatic adjustment
Faceplates	1" x 2-1/4" square corner standard
Strikes	Square corner strike 2-3/4" x 1-1/8"
Latch	Square & drive-in adjustable 2-3/8" x 2-3/4"
Bolt	1" throw, steel deadbolt
Door Handing	Reversible
Cylinder	SmartKey Security™
Temp Range & Humidity	Temperature Range: Exterior: -40F to 150F Interior: 32F to 130F Humidity: Exterior: 100% condensing Interior: 30% - 95% non-condensing

HALO TOUCHSCREEN

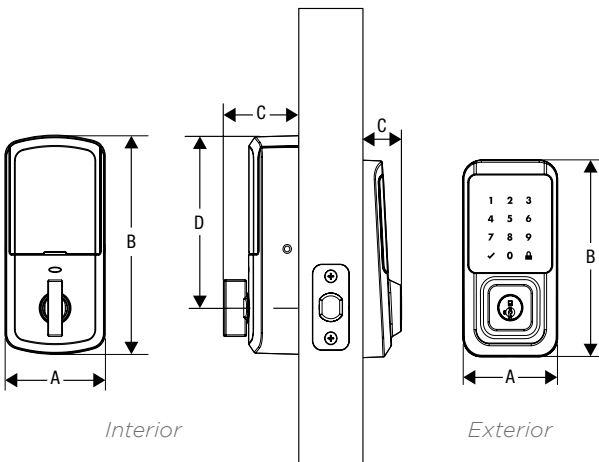

Design	A	B	C	D
Interior	2-3/4" (70 mm)	5-13/16" (147 mm)	2-1/8" (53 mm)	4-9/16" (116 mm)
Exterior	2-28/32" (73 mm)	5-5/8" (143 mm)	1-3/16" (30 mm)	-

Function	Single cylinder deadbolt
Door Prep	2-1/8" diameter bore hole & 1" diameter latch hole
Backset	Adjustable 2-3/8" or 2-3/4"
Door Thickness	1-3/8" - 2" automatic adjustment
Faceplates	1" x 2-1/4" square corner standard
Strikes	Square corner, 4-hole strike, 2-3/4" x 1-1/8"
Latch	Square corner and drive-in adjustable 2-3/4" x 2-1/8"
Bolt	1" throw, steel deadbolt
Door Handing	Reversible
Cylinder	SmartKey Security™
UL	Meets 20 minute fire rating

Intro

Electronics

Box Pack

Visual Pack

Parts

All Electronics product meets ASTM E 331 water penetration testing

AURA

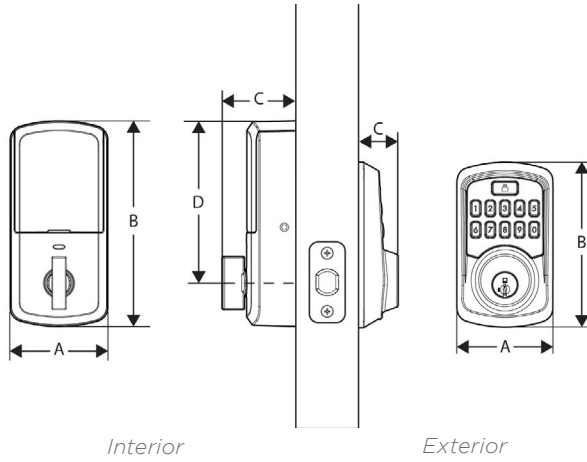

Design	A	B	C	D
Interior	2-1/4"	5-13/16"	2-1/8"	4-9/16"
Exterior	2-23/32"	4-5/8"	1-3/16"	---

Function	Single cylinder deadbolt
Door Prep	2-1/8" diameter bore hole & 1" diameter latch hole
Backset	Adjustable 2-3/8" or 2-3/4"
Door Thickness	1-3/8" - 2" automatic adjustment
Faceplates	1" - 2-3/8" square corner standard
Strikes	Square corner, 4 hole strike, 2-3/4" x 1-1/8"
Latch	Square & drive-in adjustable, 2-3/8" x 2-3/4"
Bolt	1" throw, steel deadbolt
Door Handing	Reversible
Cylinder	SmartKey Security™
UL	Meets 20 minute fire rating

SMARTCODE 10 COMMERCIAL LEVER

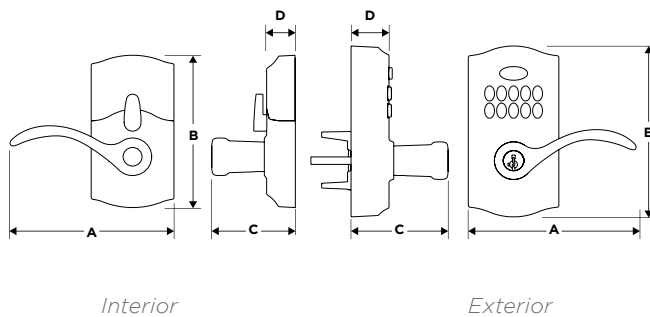

Design	AB	CD
Interior	5-5/8" 5-5/16"	2-7/8" 31/32"
Exterior	5-3/4" 5-31/32"	3-5/16" 1-13/32"

Function	Keyed entry electronic lever
Door Prep	2-1/8" diameter face hole & 1" diameter latch hole
Backset	Adjustable to 2-3/8" or 2-3/4"
Door Thickness	1-3/8" - 1-3/4"
Faceplates	1" x 2-1/4" Square corner standard
Strikes	Square corner, 4 hole strike, 2-3/4" x 1-1/8"
Latch	Square corner adjustable 2-3/8" x 2-3/4"
Bolt	1/2" throw, dead latch
Door Handing	Reversible
Cylinder	SmartKey Security™
UL	Meets 20 minute fire rating

All Electronics product meets ASTM E 331 water penetration testing

SMARTCODE 10 LEVER

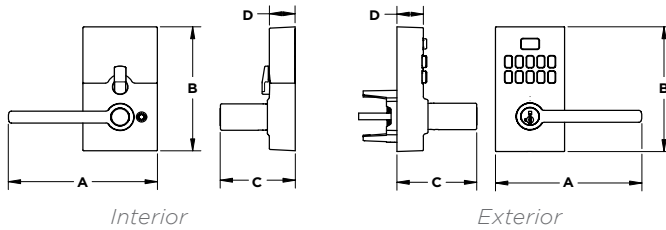

Design	A	B	C	D
Interior	5-21/32"	4-7/8"	2-27/32"	31/32"
Exterior	5-9/16"	4-29/32"	3-1/32"	1"

Function	Keyed entry electronic lever
Door Prep	Cross Bore 2-1/8". Edge Bore 1"
Backset	Adjustable to 2-3/8" or 2-3/4"
Door Thickness	1-3/8" - 1-3/4"
Faceplates	1" x 2-1/4" Square corner standard
Strikes	Square corner, 2-1/4" full lip
Latch	Adjustable to 2-3/8" or 2-3/4"
Bolt	1/2" throw, dead latch
Door Handing	Reversible
Cylinder	SmartKey Security™
UL	Meets 20 minute fire rating
Temperature Range	Exterior: -40F to 150F Interior: 32F to 130F
Humidity	Exterior: - 100% condensing Interior: 30% - 95% non-condensing

Intro
Electronics
Box Pack
Visual Pack
Parts

All Electronics product meets ASTM E 331 water penetration testing

SMARTCODE KEYPAD

CONTEMPORARY

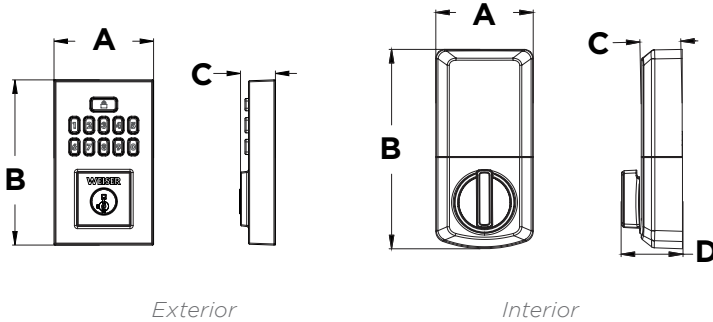

Design	A	B	C	D
Interior	2-3/4" (69 mm)	5-1/2" (140 mm)	1-1/8" (29 mm)	1-11/16" (43.2 mm)
Exterior	2-3/4" (71 mm)	4-9/16" (116 mm)	1" (25 mm)	---

TRADITIONAL

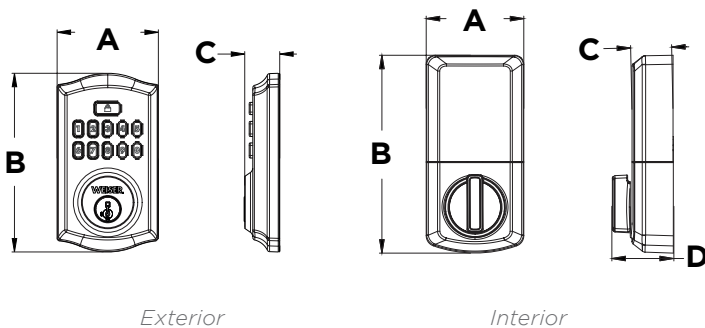

Design	A	B	C	D
Interior	2-3/4" (69 mm)	5-1/2" (140 mm)	1-1/8" (29 mm)	1-11/16" (43.2 mm)
Exterior	2-13/16" (71.7 mm)	5" (127 mm)	1" (25 mm)	---

Battery	Uses 4 x AA 6V alkaline cell batteries with approximately 1 year battery life
Function	Single cylinder deadbolt
Door Prep	1-1/2" (38mm) or 2-1/8" (54mm) diameter cross bore hole and 1" diameter edge bore hole
Backset	Adjustable 2-3/8" (60mm) or 2-3/4" (70mm)
Door Thickness	1-3/8" (35mm) to 1-3/4" (44mm) standard. Thick door service part available for 2-1/4" (57mm) thick doors.
Faceplates	1" (25 mm) x 2-1/4" (57 mm) square corner faceplate with drive-in collar standard
Strikes	2-3/4" (70mm) x 1-1/8" (29mm) square corner 4 hole strike
Bolt	1" (25mm) throw, steel bolt with anti-saw security pin
Door Handing	Reversible
Cylinder	SmartKey Security™
Temperature Range	Exterior: -40°F to 150°F (-40°C to 66°C) Interior: 32°F to 130°F (0°C to 54°C)
Humidity	Exterior: 100% condensing Interior: 30% to 95% non-condensing
Codes	Up to 50 user codes and 10 one-time user codes with optional programming code

All Electronics product meets ASTM E 331 water penetration testing

SMARTCODE TOUCHPAD

CONTEMPORARY

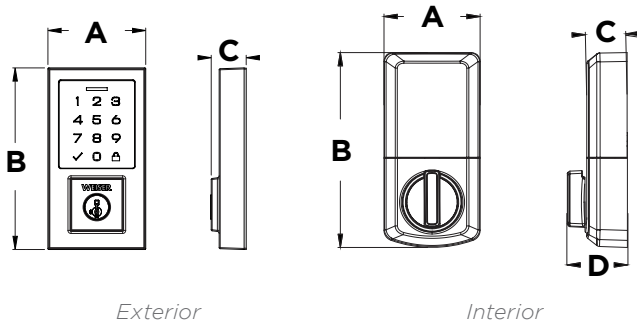

Design	A	B	C	D
Interior	2-3/4" (70 mm)	5-3/16" (132 mm)	1" (25 mm)	1-11/16" (43 mm)
Exterior	2-3/4" (70 mm)	5-1/2" (140 mm)	1-1/8" (29 mm)	---

TRADITIONAL

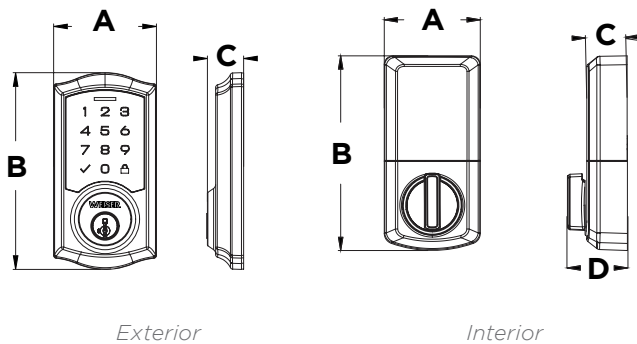

Design	A	B	C	D
Interior	2-13/16" (71 mm)	5-3/8" (137 mm)	1" (25 mm)	1-11/16" (43 mm)
Exterior	2-3/4" (70 mm)	5-1/2" (140 mm)	1-1/8" (29 mm)	---

Battery	Uses 4 x AA 6V alkaline cell batteries with approximately 1 year battery life
Function	Single cylinder deadbolt
Door Prep	1-1/2" (38mm) or 2-1/8" (54mm) diameter cross bore hole and 1" diameter edge bore hole
Backset	Adjustable 2-3/8" (60mm) or 2-3/4" (70mm)
Door Thickness	1-3/8" (35mm) to 1-3/4" (44mm) standard. Thick door service part available for 2-1/4" (57mm) thick doors.
Faceplates	1" (25 mm) x 2-1/4" (57 mm) square corner faceplate with drive-in collar standard
Strikes	2-3/4" (70mm) x 1-1/8" (29mm) square corner 4 hole strike
Bolt	1" (25mm) throw, steel bolt with anti-saw security pin
Door Handing	Reversible
Cylinder	SmartKey Security™
Temperature Range	Exterior: -40°F to 150°F (-40°C to 66°C) Interior: 32°F to 130°F (0°C to 54°C)
Humidity	Exterior: 100% condensing Interior: 30% to 95% non-condensing
Codes	Up to 50 user codes and 10 one-time user codes with optional programming code

All Electronics product meets ASTM E 331 water penetration testing

POWERBOLT 3

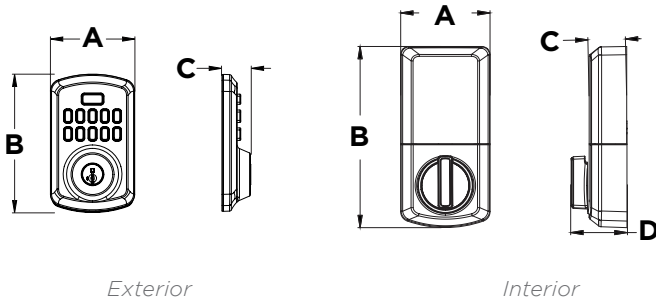

Design	A	B	C	D
Interior	2-7/8"	7-7/16"	1-3/4"	5-15/16"
Exterior	2-3/4"	4-3/4"	1-15/16"	---

Battery	6V, 4 x AA alkaline batteries, 12-month battery life (batteries not included)
Function	Single cylinder deadbolt
Door Prep	1-1/2" or 2-1/8" diameter cross bore hole and 1" diameter edge bore hole
Backset	Adjustable 2-3/8" or 2-3/4"
Door Thickness	1-3/8" to 1-3/4" standard. Service part available for 2 1/4" thick doors
Faceplates	1" x 2-1/4" sound corner faceplate with drive-in collar standard
Strikes	2-3/4" x 1-1/8" sound corner 2-hole strike
Bolt	1" throw, steel bolt
Door Handing	Reversible
Cylinder	SmartKey Security™ KW1 cylinder
Temperature Range	Exterior: -40°F to 150°F (-40°C to 66°C) Interior: 32°F to 130°F (0°C to 54°C)
Humidity	Exterior: 100% condensing Interior: 30% to 95% non-condensing
Codes	Up to 25 user codes and 5 one-time user codes with optional programming code

All Electronics product meets ASTM E 331 water penetration testing

ELEMENTS KEYPAD

CONTEMPORARY

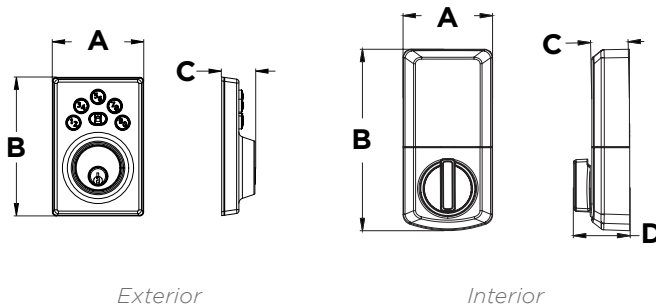

Design	A	B	C	D
Interior	2-23/32"	5-1/2"	1-5/32"	1-11/16"
Exterior	2-25/32"	4-7/32"	1-1/32"	---

TRADITIONAL

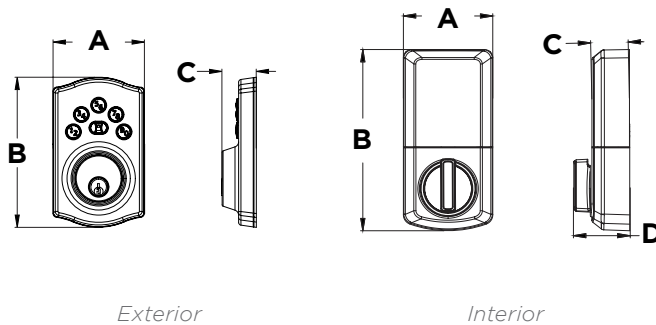

Design	A	B	C	D
Interior	2-23/32"	5-1/2"	1-5/32"	1-11/16"
Exterior	2-11/16"	4-7/16"	1-1/32"	---

Battery	6V, 4 x AA alkaline batteries, 12-month battery life (batteries not included)
Function	Single cylinder deadbolt
Door Prep	1-1/2" or 2-1/8" diameter cross bore hole and 1" diameter edge bore hole
Backset	Adjustable 2-3/8" or 2-3/4"
Door Thickness	1-3/8" to 1-3/4" standard. Service part available for 2-1/4" thick doors
Faceplates	1" x 2-1/4" sound corner faceplate with drive-in collar standard
Strikes	2-3/4" x 1-1/8" sound corner 2-hole strike
Bolt	1" throw, steel bolt
Door Handing	Reversible
Cylinder	KW1 P&T cylinder
Temperature Range	Exterior: -40°F to 150°F (-40°C to 66°C) Interior: 32°F to 130°F (0°C to 54°C)
Humidity	Exterior: 100% condensing Interior: 30% to 95% non-condensing
Codes	Up to 12 user codes and 2 one-time user codes with optional programming code

Intro
Electronics
Box Pack
Visual Pack
Parts

BOX PACK

Pfister

BATH HARDWARE PROGRAM

Introducing the Pfister Bath Hardware Program. With multiple designs and finishes to choose from pairing your bath accessories to your Weiser door hardware is as easy as ever. Simply work with your Weiser rep to start placing your Pfister bath accessory orders.







Contact your Weiser Rep for pricing and to order today



Our in-stock program of 2 families bothin 3 different finishes ensures timely delivery on the most popular design trends. Our full line of accessories are also available for custom order to ensure the perfect finish and design match for your project.

PFIRST MODERN

Pfirst Modern effortlessly combines clean lines with contemporary curves to create an up-to-date, modern style statement for any bathroom project.



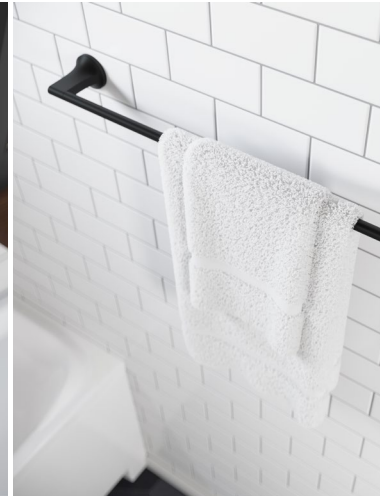

	Model	Finish	Case Qty
18" Towel Bar 	BTB-PFM1C	Polished Chrome	3
	BTB-PFM1GS	Brushed Nickel	3
	BTB-PFM1B	Matte Black	3
24" Towel Bar 	BTB-PFM2C	Polished Chrome	3
	BTB-PFM2GS	Brushed Nickel	3
	BTB-PFM2B	Matte Black	3
Robe Hook 	BRH-PFM0C	Polished Chrome	3
	BRH-PFM0GS	Brushed Nickel	3
	BRH-PFM0B	Matte Black	3
Paper Holder 	BPH-PFM0C	Polished Chrome	3
	BPH-PFM0GS	Brushed Nickel	3
	BPH-PFM0B	Matte Black	3
Towel Ring 	BRB-PFM0C	Polished Chrome	3
	BRB-PFM0GS	Brushed Nickel	3
	BRB-PFM0B	Matte Black	3



Contact your Weiser Rep for pricing and to order today

DECKARD

The clean, horizontal lines in this design create a precise aesthetic as the contrasting subtle curves offer balance.

	Model	Finish	Case Qty
18" Towel Bar 	BTB-DA1C	Polished Chrome	3
	BTB-DA1K	Brushed Nickel	3
	BTB-DA1B	Matte Black	3
24" Towel Bar 	BTB-DA2C	Polished Chrome	3
	BTB-DA2K	Brushed Nickel	3
	BTB-DA2B	Matte Black	3
Robe Hook 	BRH-DA1C	Polished Chrome	3
	BRH-DA1K	Brushed Nickel	3
	BRH-DA1B	Matte Black	3
Paper Holder 	BPH-DA1C	Polished Chrome	3
	BPH-DA1K	Brushed Nickel	3
	BPH-DA1B	Matte Black	3
Towel Ring 	BRB-DA1C	Polished Chrome	3
	BRB-DA1K	Brushed Nickel	3
	BRB-DA1B	Matte Black	3

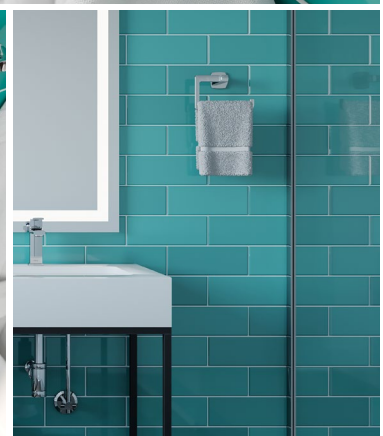

Intro

Electronics

Box Pack

Visual Pack

Parts

HANDLESETS GROUP A	Function	GA9771 / GA8771 Single Cylinder	GA7771 Handleset Minus
	List Price	\$366	\$285

PRAGUE	Finish Availability		GA8771 PGH
	15	Satin Nickel	9GA87710-009
	26	Polished Chrome	9GA87710-011
	26D	Satin Chrome	9GA87710-012
	514	Matte Black	9GA87710-010
	Case Quantity		

SAN CLEMENTE	Finish Availability		GA8771 SCE	GA7771 SCE/HFL ONLY
	4	Satin Brass	9GA87710-016	--
	15	Satin Nickel	9GA87710-001	9GLA77710-007
	26	Polished Chrome	9GA87710-013	--
	26D	Satin Chrome	9GA87710-002	--
	514	Matte Black	9GA87710-003	9GLA77710-001
	Case Quantity			4

TAVARIS	Finish Availability		GA9771 TVH
	15	Satin Nickel	9GA97710-030
	26	Polished Chrome	9GA97710-031
	26D	Satin Chrome	9GA97710-032
	514	Matte Black	9GA97710-026
	Case Quantity		

15	Satin Nickel	9GA97710-039	
26D	Satin Chrome	9GA97710-038	
514	Matte Black	9GA97710-037	
Case Quantity			4

NOTE: All box pack handlesets are ordered LESS INTERIOR PACK (LIP). Interior packs must be ordered separately.

HANDLESETS GROUP A	Function	GA8771 Single Cylinder
	List Price	\$366

VANCOUVER	Finish Availability	GA8771 VNH
	15 Satin Nickel	9GA87710-007
	514 Matte Black	9GA87710-008
	Case Quantity	4

*Halifax Full Trim Escutcheon available for Vancouver Handleset only. See Page 32 for SKU number.



HANDLESETS GROUP B	Function	GA9771 Single Cylinder	GA7771 Handleset Minus
	List Price	\$330	\$285

AUGUSTA	Finish Availability	GA9771 A
	15 Satin Nickel	9GA97710-003
	26D Satin Chrome	9GA97710-005
	514 Matte Black	9GA97710-007
	Case Quantity	6

HAWTHORNE	Finish Availability	GA9771 HE	GA7771 HE/TC
	11P Venetian Bronze	9GA97710-022	9GLA77710-004
	15 Satin Nickel	9GA97710-025	--
	Case Quantity	6	2

NOTE: All box pack handlesets are ordered LESS INTERIOR PACK (LIP). Interior packs must be ordered separately.

HANDLESET INTERIOR PACK

Compatible with Prague, San Clemente & Vancouver	Function	GLA8675 Single Cylinder	GLA8675 Single Cylinder	GLA8675 Full Escutcheon	GLA86 Inactive	GLA86 Inactive
	List Price	\$76	\$76	\$96	\$76	\$76

BRETON	Finish Availability	SQUARE ROSE	ROUND ROSE	SQUARE ROSE	ROUND ROSE
15	Satin Nickel	9GLA86750-046	9GLA86750-045	--	9GLA860-005 9GLA860-006
26	Polished Chrome	9GLA86750-043	9GLA86750-042	--	9GLA860-003 9GLA860-004
26D	Satin Chrome	9GLA86750-044	--	--	--
514	Matte Black	9GLA86750-041	9GLA86750-040	--	9GLA860-001 9GLA860-002

CAMBIE	Finish Availability	SQUARE ROSE	ROUND ROSE
15	Satin Nickel	9GA86750-001	9GA86750-003
514	Matte Black	9GA86750-002	9GA86750-004

HALIFAX	Finish Availability	SQUARE ROSE	ROUND ROSE	FULL ESCUTCHEON
4	Satin Brass	9GLA86750-067	--	--
15	Satin Nickel	9GLA86750-001	9GLA86750-048	9GLA86750-021
26D	Satin Chrome	9GLA86750-002	--	--
514	Matte Black	9GLA86750-003	9GLA86750-047	9GLA86750-022

LISBON	Finish Availability	SQUARE ROSE	ROUND ROSE
15	Satin Nickel	9GLA86750-017	9GLA86750-050
514	Matte Black	9GLA86750-018	9GLA86750-049

MILAN	Finish Availability	SQUARE ROSE	ROUND ROSE
15	Satin Nickel	9GLA86750-054	9GLA86750-055
26	Polished Chrome	--	9GLA86750-053
514	Matte Black	9GLA86750-051	9GLA86750-052

MONTREAL	Finish Availability	SQUARE ROSE
15	Satin Nickel	9GLA86750-016

PERTH	Finish Availability	SQUARE ROSE
15	Satin Nickel	9GLA86750-038
514	Matte Black	9GLA86750-039

Intro

Electronics

Box Pack

Visual Pack

Parts

Compatible with Prague, San Clemente & Vancouver	Function	GLA8675 Single Cylinder	GLA8675 Single Cylinder
	List Price	\$76	\$76

PRAGUE LEVER		Finish Availability	
15	Satin Nickel	9GLA86750-026	
26	Polished Chrome	9GLA86750-028	
26D	Satin Chrome	9GLA86750-029	
514	Matte Black	9GLA86750-027	

PRAGUE KNOB		Finish Availability	
15	Satin Nickel	9GA86750-005	
26	Polished Chrome	9GA86750-007	
26D	Satin Chrome	9GA86750-008	
514	Matte Black	9GA86750-006	

SEDONA		Finish Availability	LEFT HANDED	RIGHT HANDED
4	Satin Brass	9GLA86750-035	9GLA86750-034	9GLA86750-034
15	Satin Nickel	9GLA86750-031	9GLA86750-030	9GLA86750-030
514	Matte Black	9GLA86750-033	9GLA86750-032	9GLA86750-032

SINGAPORE		Finish Availability	SQUARE ROSE	ROUND ROSE
15	Satin Nickel	9GLA86750-023	9GLA86750-023	9GLA86750-059
26	Polished Chrome	9GLA86750-025	9GLA86750-025	9GLA86750-057
26D	Satin Chrome	9GLA86750-058	9GLA86750-058	--
514	Matte Black	9GLA86750-024	9GLA86750-024	9GLA86750-056

SYDNEY		Finish Availability	SQUARE ROSE	ROUND ROSE
15	Satin Nickel	9GLA86750-063	9GLA86750-063	9GLA86750-064
26D	Satin Chrome	9GLA86750-062	9GLA86750-062	--
514	Matte Black	9GLA86750-060	9GLA86750-060	9GLA86750-061

TRAFFORD		Finish Availability	
15	Satin Nickel	9GLA86750-036	
514	Matte Black	9GLA86750-037	

HANDLESET INTERIOR PACK

Compatible with Augusta, Hawtorne and Tavaris	Function	GLA9675 Single Cylinder	GLA9675 Single Cylinder
	List Price	\$76	\$76

BRETON	Finish Availability		SQUARE ROSE
15	Satin Nickel	9GLA96750-174	
26D	Satin Chrome	9GLA96750-175	
514	Matte Black	9GLA96750-181	

CAMBIE	Finish Availability		SQUARE ROSE	ROUND ROSE
15	Satin Nickel	9GA96750-105	9GA96750-107	
514	Matte Black	9GA96750-106	9GA96750-108	

FAIRFAX	Finish Availability		
26D	Satin Chrome	9GA96750-075	

HALIFAX	Finish Availability		SQUARE ROSE	ROUND ROSE
11P	Venetian Bronze	9GLA96750-146		--
15	Satin Nickel	9GLA96750-148	9GLA96750-147	
26	Polished Chrome	9GLA96750-150	9GLA96750-149	
26D	Satin Chrome	9GLA96750-151		--
514	Matte Black	9GLA96750-153	9GLA96750-152	

HUNTINGTON	Finish Availability		
15	Satin Nickel	9GA96750-076	
26D	Satin Chrome	9GA96750-077	

KATELLA	Finish Availability		
15	Satin Nickel	9GLA96750-179	
514	Matte Black	9GLA96750-180	

KIM	Finish Availability		
15	Satin Nickel	9GLA96750-133	
26D	Satin Chrome	9GLA96750-182	

Intro

Electronics

Box Pack

Visual Pack

Parts

Compatible with Augusta, Hawthorne and Tavaris	Function	GLA9675 Single Cylinder	GLA9675 Single Cylinder
	List Price	\$76	\$76

LISBON	Finish Availability		SQUARE ROSE	ROUND ROSE
15	Satin Nickel		9GLA96750-170	9GLA96750-169
514	Matte Black		9GLA96750-173	--

MILAN	Finish Availability		SQUARE ROSE	ROUND ROSE
15	Satin Nickel		9GLA96750-194	9GLA96750-154
26	Polished Chrome		--	9GLA96750-155
26D	Satin Chrome		--	9GLA96750-156
514	Matte Black		9GLA96750-192	9GLA96750-191

MONTREAL	Finish Availability		SQUARE ROSE
15	Satin Nickel		9GLA96750-157
514	Matte Black		9GLA96750-159

SINGAPORE	Finish Availability		SQUARE ROSE	ROUND ROSE
15	Satin Nickel		9GLA96750-176	9GLA96750-186
26	Polished Chrome		9GLA96750-178	9GLA96750-184
26D	Satin Chrome		9GLA96750-185	--
514	Matte Black		9GLA96750-177	9GLA96750-183

TOLUCA	Finish Availability		LEFT HANDED	RIGHT HANDED
3	Brass		9GLA96750-142	9GLA96750-188
15	Satin Nickel		9GLA96750-136	9GLA96750-137
514	Matte Black		9GLA96750-144	9GLA96750-190

TROY	Finish Availability		
15	Satin Nickel		9GA96750-086
26D	Satin Chrome		9GA96750-088
514	Matte Black		9GA96750-090

LEVERS GROUP A	Function	101 Hall/Closet	101 Hall/Closet - 20 Min Fire Rated	101 Hall/Closet - 3 Hr Fire Rated	331 Bed/Bath	535 Keyed Entry	12 Inactive
	List Price	\$88	\$88	\$108	\$105	\$158	\$53

DANE	Finish Availability	GLA 101 D			GLA 331 D	GLA 535 D	GLA 12 D
	26D Satin Chrome	9GLA1010-182	--	--	9GLA3310-160	9GLA5350-201	9GLA120-159
	Case Quantity	12	--	--	12	12	6

SINGAPORE - SQUARE ROSE	Finish Availability	GLA 101 SAL	GLA 101 SAL FD	GLA 101 SAL UL	GLA 331 SAL	GLA 535 SAL	GLA 12 SAL
	15 Satin Nickel	--	9GLA1010-120	9GLA1010-168	9GLA3310-119	9GLA5350-166	9GLA120-114
	26 Polished Chrome	9GLA1010-122	--	9GLA1010-179	9GLA3310-121	9GLA5350-168	9GLA120-116
	26D Satin Chrome	9GLA1010-186	--	--	9GLA3310-166	9GLA5350-213	9GLA120-165
	514 Matte Black	9GLA1010-121	--	9GLA1010-169	9GLA3310-120	9GLA5350-167	9GLA120-115
	Case Quantity	12	12	12	12	12	6

SINGAPORE - ROUND ROSE	Finish Availability	GLA 101 SAL		GLA 101 SAL UL	GLA 331 SAL	GLA 535 SAL	GLA 12 SAL
	15 Satin Nickel	9GLA1010-123	--	9GLA1010-170	9GLA3310-122	9GLA5350-210	9GLA120-117
	26 Polished Chrome	9GLA1010-124	--	9GLA1010-171	9GLA3310-123	9GLA5350-211	9GLA120-118
	514 Matte Black	9GLA1010-185	--	9GLA1010-180	9GLA3310-165	9GLA5350-212	9GLA120-164
	Case Quantity	12	--	12	12	12	6

Intro

Electronics

Box Pack

Visual Pack

Parts

LEVERS GROUP B	Function	101 Hall/Closet	101 Hall/Closet - 20 Min Fire Rated	331 Bed/Bath	535 Keyed Entry	12 Inactive	12 Inactive
	List Price	\$81	\$81	\$98	\$154	\$49	\$49

HALIFAX	Finish Availability		GLA 101 HFL FD	GLA 331 HFL	GLA 535 HFL	GLA 12 HFL
	4 Satin Brass	--	9GLA1010-152	9GLA3310-145	9GLA5350-186	9GLA120-138
	Case Quantity	--	12	12	12	6

PERTH	Finish Availability		GLA 101 PHL	GLA 331 PHL	GLA 535 PHL	GLA 12 PHL
	15 Satin Nickel	--	9GLA1010-165	9GLA3310-158	9GLA5350-199	9GLA120-157
	514 Matte Black	--	9GLA1010-166	9GLA3310-159	9GLA5350-200	9GLA120-158
	Case Quantity		12	12	12	6

PRAGUE - MODERN ROSE	Finish Availability		GLA 101 PGL	GLA 331 PGL	GLA 535 PGL	GLA 12 PGL
	15 Satin Nickel	--	9GLA1010-139	9GLA3310-138	9GLA5350-209	9GLA120-133
	26 Polished Chrome	--	9GLA1010-141	9GLA3310-140	9GLA5350-206	9GLA120-135
	26D Satin Chrome	--	9GLA1010-142	9GLA3310-141	9GLA5350-208	9GLA120-136
	514 Matte Black	--	9GLA1010-140	9GLA3310-139	9GLA5350-207	9GLA120-134
	Case Quantity		12	12	12	6

SEDONA	Finish Availability		GLA 101 SEL	GLA 331 SEL	GLA 535 SEL	GLA 12 SEL LH	GLA 12 SEL RH
	4 Satin Brass	--	9GLA1010-158	9GLA3310-151	9GLA5350-192	9GLA120-150	9GLA120-149
	15 Satin Nickel	--	9GLA1010-156	9GLA3310-149	9GLA5350-190	9GLA120-146	9GLA120-145
	514 Matte Black	--	9GLA1010-157	9GLA3310-150	9GLA5350-191	9GLA120-148	9GLA120-147
	Case Quantity		12	12	12	6	6

TRAFFORD	Finish Availability		GLA 101 TDL	GLA 331 TDL	GLA 535 TDL	GLA 12 TDL
	15 Satin Nickel	--	9GLA1010-161	9GLA3310-154	9GLA5350-195	9GLA120-153
	514 Matte Black	--	9GLA1010-162	9GLA3310-155	9GLA5350-196	9GLA120-154
	Case Quantity		12	12	12	6

Intro

Electronics

Box Pack

Visual Pack

Parts

LEVERS GROUP C	Function	101 Hall/Closet	101 Hall/Closet - 20 Min Fire Rated	101 Hall/Closet - 3 Hr Fire Rated	331 Bed/Bath	535 Keyed Entry	12 Inactive
	List Price	\$77	\$77	\$97	\$94	\$147	\$46

HALIFAX - SQUARE ROSE		Finish Availability	GLA 101 HFL	GLA 101 HFL FD	GLA 101 HFL UL	GLA 331 HFL	GLA 535 HFL	GLA 12 HFL
	11P	Venetian Bronze	9GLA1010-076	--	--	9GLA3310-075	9GLA5350-105	9GLA120-068
	15	Satin Nickel	--	9GLA1010-059	9GLA1010-177	9GLA3310-058	9GLA5350-088	9GLA120-047
	26	Polished Chrome	--	9GLA1010-079	9GLA1010-176	9GLA3310-078	9GLA5350-107	9GLA120-071
	26D	Satin Chrome	--	9GLA1010-080	9GLA1010-175	9GLA3310-079	9GLA5350-109	9GLA120-072
	514	Matte Black	--	9GLA1010-082	9GLA1010-173	9GLA3310-081	9GLA5350-110	9GLA120-074
Case Quantity			12	12	12	12	12	6

HALIFAX - ROUND ROSE		Finish Availability	GLA 101 HFL	GLA 101 HFL FD	GLA 101 HFL UL	GLA 331 HFL	GLA 535 HFL	GLA 12 HFL
	11P	Venetian Bronze	9GLA1010-183	--	--	9GLA3310-161	9GLA5350-202	9GLA120-113
	15	Satin Nickel	--	9GLA1010-077	9GLA1010-178	9GLA3310-076	9GLA5350-106	9GLA120-069
	26	Polished Chrome	--	9GLA1010-078	--	9GLA3310-077	9GLA5350-108	9GLA120-070
	26D	Satin Chrome	--	9GLA1010-167	--	9GLA3310-162	9GLA5350-203	9GLA120-161
	514	Matte Black	--	9GLA1010-081	9GLA1010-174	9GLA3310-080	9GLA5350-111	9GLA120-073
Case Quantity			12	12	12	12	12	6

KATELLA		Finish Availability	GLA 101 KAL			GLA 331 KAL	GLA 535 KAL	GLA 12 KAL
	15	Satin Nickel	9GLA1010-130	--	--	9GLA3310-129	9GLA5350-174	9GLA120-124
	514	Matte Black	9GLA1010-131	--	--	9GLA3310-130	9GLA5350-175	9GLA120-125
	Case Quantity			12	--	--	12	12

LISBON - SQUARE ROSE		Finish Availability	GLA 101 LSL			GLA 331 LSL	GLA 535 LSL	GLA 12 LSL
	15	Satin Nickel	9GLA1010-095	--	--	9GLA3310-094	9GLA5350-123	9GLA120-087
	514	Matte Black	9GLA1010-098	--	--	9GLA3310-097	9GLA5350-127	9GLA120-090
	Case Quantity			12	--	--	12	12

Intro

Electronics

Box Pack

Visual Pack

Parts

LEVERS GROUP C	Function	101 Hall/Closet	101 Hall/Closet - 20 Min Fire Rated	101 Hall/Closet - 3 Hr Fire Rated	331 Bed/Bath	535 Keyed Entry	12 Inactive
	List Price	\$77	\$77	\$97	\$94	\$147	\$46

LISBON - ROUND ROSE		Finish Availability	GLA 101 LSL	GLA101 LSL FD	GLA 331 LSL	GLA 535 LSL	GLA 12 LSL	
	15	Satin Nickel	--	9GLA1010-094	--	9GLA3310-093	9GLA5350-124	9GLA120-086
	514	Matte Black	9GLA1010-184	--	--	9GLA3310-163	9GLA5350-204	9GLA120-162
	Case Quantity			12	12	--	12	12

MILAN - SQUARE ROSE		Finish Availability	GLA 101 MIL	GLA 331 MIL	GLA 535 MIL	GLA 12 MIL		
	15	Satin Nickel	--	9GLA1010-125	--	9GLA3310-124	9GLA5350-169	9GLA120-119
	26D	Satin Chrome	--	9GLA1010-172	--	9GLA3310-164	9GLA5350-205	9GLA120-163
	514	Matte Black	--	9GLA1010-128	--	9GLA3310-127	9GLA5350-172	9GLA120-122
Case Quantity			--	12	--	12	12	6

MILAN - ROUND ROSE		Finish Availability	GLA 101 MIL FD	GLA 331 MIL	GLA 535 MIL	GLA 12 MIL		
	15	Satin Nickel	--	9GLA1010-083	--	9GLA3310-082	9GLA5350-112	9GLA120-075
	26	Polished Chrome	--	9GLA1010-084	--	9GLA3310-083	9GLA5350-113	9GLA120-076
	26D	Satin Chrome	--	9GLA1010-085	--	9GLA3310-084	9GLA5350-114	9GLA120-077
	514	Matte Black	--	9GLA1010-127	--	9GLA3310-126	9GLA5350-171	9GLA120-121
Case Quantity			--	12	--	12	12	6

MONTREAL - SQUARE ROSE		Finish Availability	GLA 101 MRL	GLA 331 MRL	GLA 535 MRL	GLA 12 MRL		
	15	Satin Nickel	9GLA1010-086	--	--	9GLA3310-085	9GLA5350-115	9GLA120-078
	514	Matte Black	9GLA1010-088	--	--	9GLA3310-087	9GLA5350-117	9GLA120-080
	Case Quantity			12	--	--	12	12

Intro

Electronics

Box Pack

Visual Pack

Parts

Intro

LEVERS GROUP C	Function	101 Hall/Closet	331 Bed/Bath	535 Keyed Entry	12 Inactive
	List Price	\$77	\$94	\$147	\$46

Electronics

SYDNEY - SQUARE ROSE		Finish Availability	GLA 101 SYL	GLA 331 SYL	GLA 535 SYL	GLA 12 SYL
	15	Satin Nickel	9GLA1010-189	9GLA3310-169	9GLA5350-216	9GLA120-168
	514	Matte Black	9GLA1010-188	9GLA3310-168	9GLA5350-215	9GLA120-167
	Case Quantity		12	12	12	6

SYDNEY - ROUND ROSE		Finish Availability	GLA 101 SYL	GLA 331 SYL	GLA 535 SYL	GLA 12 SYL
	15	Satin Nickel	9GLA1010-089	9GLA3310-088	9GLA5350-118	9GLA120-081
	514	Matte Black	9GLA1010-187	9GLA3310-167	9GLA5350-214	9GLA120-166
	Case Quantity		12	12	12	6

Box Pack

LEVERS GROUP D	Function	101 Hall/Closet	331 Bed/Bath	535 Keyed Entry	12 Inactive LH	12 Inactive RH
	List Price	\$73	\$90	\$143	\$38	\$38

Visual Pack

TOLUCA		Finish Availability	GLA 101 TC	GLA 331 TC	GLA 535 TC	GLA 12 TC LH	GLA 12 TC RH
	3	Brass	9GLA1010-190	9GLA3310-170	9GLA5350-217	9GLA120-169	9GLA120-170
	15	Satin Nickel	9GLA1010-114	9GLA3310-113	9GLA5350-157	9GLA120-103	9GLA120-104
	514	Matte Black	9GLA1010-191	9GLA3310-171	9GLA5350-218	9GLA120-171	9GLA120-172
	Case Quantity		12	12	12	6	6

Parts

KNOBS GROUP A	Function	101 Hall/Closet	331 Bed/Bath	531 Keyed Entry	12 Inactive
	List Price	\$66	\$83	\$139	\$33

PRAGUE - MODERN ROSE	Finish Availability	GA 101 PGK	GA 331 PGK	GA 531 PGK	GA 12 PGK
	15 Satin Nickel	9GA1010-155	9GA3310-158	9GA5310-215	9GA120-102
	514 Matte Black	9GA1010-156	9GA3310-159	9GA5310-216	9GA120-103
	Case Quantity	12	12	12	6

KNOBS GROUP B	Function	101 Hall/Closet	331 Bed/Bath	531 Keyed Entry	12 Inactive
	List Price	\$62	\$79	\$132	\$30

CAMBIE - SQUARE ROSE	Finish Availability	GA 101 CBK	GA 331 CBK	GA 531 CBK	GA 12 CBK
	15 Satin Nickel	9GA1010-149	9GA3310-152	9GA5310-195	9GA120-096
	514 Matte Black	9GA1010-150	9GA3310-153	9GA5310-197	9GA120-097
	Case Quantity	12	12	12	6

CAMBIE - ROUND ROSE	Finish Availability	GA 101 CBK	GA 331 CBK	GA 531 CBK	GA 12 CBK
	15 Satin Nickel	9GA1010-151	9GA3310-154	9GA5310-194	9GA120-098
	514 Matte Black	9GA1010-152	9GA3310-155	9GA5310-196	9GA120-099
	Case Quantity	12	12	12	6

Intro

Electronics

Box Pack

Visual Pack

Parts

Intro

Electronics

Box Pack

Visual Pack

Parts

KNOBS GROUP C	Function	101 Hall/Closet	331 Bed/Bath	531 Keyed Entry	581 Storeroom	12 Inactive
	List Price	\$56	\$73	\$126	\$165	\$30

HUNTINGTON		Finish Availability	GA 101 HT	GA 331 HT	GA 531 HT	GA 581 HT	GA 12 HT
	15	Satin Nickel	9GA1010-129	9GA3310-125	9GA5310-200	9GA5810-002	9GA120-083
	26D	Satin Chrome	9GA1010-130	9GA3310-126	9GA5310-201	9GA5810-001	9GA120-084
	Case Quantity			12	12	12	12

15	Satin Nickel			9GA5310-218	
26D	Satin Chrome			9GA5310-217	
Case Quantity				12	

PHOENIX		Finish Availability	GA 101 P	GA 331 P	GA 531 P		GA 12 P
	15	Satin Nickel	9GA1010-132	9GA3310-128	9GA5310-204	--	9GA120-086
	Case Quantity		12	12	12	--	6

KNOBS GROUP D	Function	101 Hall/Closet	331 Bed/Bath	531 Keyed Entry	581 Storeroom	12 Inactive*
	List Price	\$48	\$65	\$118	\$156	\$24

TROY		Finish Availability	GA 101 T	GA 331 T	GA 531 T	GA 581 T	GA 12 T
	15	Satin Nickel	9GA1010-133	9GA3310-129	9GA5310-207	--	9GA120-087
	26D	Satin Chrome	9GA1010-128	9GA3310-124	9GA5310-209	9GA5810-003	9GA120-082
	514	Matte Black	9GA1010-134	9GA3310-130	9GA5310-210	--	9GA120-088
	Case Quantity			12	12	12	12

DOWNTOWN GD 1471 - SQUARE		Finish Availability	GD 1471 Single Cylinder	GD1471 Single Cylinder - 20 Min Fire Rated
	4	Satin Brass	--	9GD14710-040
	15	Satin Nickel	9GD14710-026	--
	26	Polished Chrome	9GD14710-027	--
	26D	Satin Chrome	9GD14710-029	--
	514	Matte Black	9GD14710-031	--
	List Price			\$109
Case Quantity			12	12

15	Satin Nickel	--	9GD14710-042	
26D	Satin Chrome	--	9GD14710-041	
List Price		--	\$109	
Case Quantity			12	

MIDTOWN GD 1471		Finish Availability	GD 1471 Single Cylinder
	15	Satin Nickel	9GD14710-035
	26	Polished Chrome	9GD14710-037
	26D	Satin Chrome	9GD14710-038
	514	Matte Black	9GD14710-036
	List Price		
Case Quantity			12

UPTOWN GD 1471 - ROUND		Finish Availability	GD 1471 Single Cylinder
	15	Satin Nickel	9GD14710-025
	26	Polished Chrome	9GD14710-043
	List Price		
Case Quantity			12

Intro
Electronics
Box Pack
Visual Pack
Parts

GCD 9471		Finish Availability		GCD 9471 Single Cylinder	GCD9471 Single Cylinder - 3 Hr Fire Rated
	15	Satin Nickel		9GCD94710-064	9GCD94710-062
	514	Matte Black		9GCD94710-063	--
	List Price			\$100	\$120
	Case Quantity			12	12

GD 9471		Finish Availability		GD 9471 Single Cylinder - 20 Min Fire Rated
	15	Satin Nickel		9GD94710-095
	26D	Satin Chrome		9GD94710-097
	514	Matte Black		9GD94710-099
	List Price			\$97
	Case Quantity			12

3	Brass		9GD94710-103	
15	Satin Nickel		9GD94710-100	
26D	Satin Chrome		9GD94710-101	
514	Matte Black		9GD94710-102	
List Price			\$97	
Case Quantity			12	

SSD 9471 - SQUARE



Finish Availability		SSD9471 Single Cylinder - 20 Min Fire Rated
15	Satin Nickel	9SSD94710-024
26	Polished Chrome	9SSD94710-026
26D	Satin Chrome	9SSD94710-028
514	Matte Black	9SSD94710-030
List Price		\$75
Case Quantity		12

15	Satin Nickel	9SSD94710-052	
26	Polished Chrome	9SSD94710-048	
26D	Satin Chrome	9SSD94710-050	
514	Matte Black	9SSD94710-045	
List Price		\$75	
Case Quantity		12	

15	Satin Nickel	9SSD94710-038	
26	Polished Chrome	9SSD94710-039	
26D	Satin Chrome	9SSD94710-040	
514	Matte Black	9SSD94710-037	
List Price		\$75	
Case Quantity		12	

15	Satin Nickel	9SSD94710-031	
26	Polished Chrome	9SSD94710-033	
514	Matte Black	9SSD94710-032	
List Price		\$75	
Case Quantity		12	

NOTE: Keyed to 23155.
No keys included.
Please order keys
below.

PART NUMBER	DESCRIPTION	LIST PRICE
84282-001	SmartKey Key Keyed to 23155 - 4 Sets of 2 Keys Keyed Alike 8	\$20.80

Intro

Electronics

Box Pack

Visual Pack

Parts

SSD 9471 - ROUND



Finish Availability		SSD9471 Single Cylinder - 20 Min Fire Rated
15	Satin Nickel	9SSD94710-023
26	Polished Chrome	9SSD94710-025
26D	Satin Chrome	9SSD94710-027
514	Matte Black	9SSD94710-029
List Price		\$75
Case Quantity		12

15	Satin Nickel	9SSD94710-051	
26	Polished Chrome	9SSD94710-047	
26D	Satin Chrome	9SSD94710-049	
514	Matte Black	9SSD94710-044	
List Price		\$75	
Case Quantity		12	

15	Satin Nickel	9SSD94710-042	
26	Polished Chrome	9SSD94710-046	
26D	Satin Chrome	9SSD94710-043	
514	Matte Black	9SSD94710-041	
List Price		\$75	
Case Quantity		12	

15	Satin Nickel	9SSD94710-034	
26	Polished Chrome	9SSD94710-036	
514	Matte Black	9SSD94710-035	
List Price		\$75	
Case Quantity		12	

NOTE: Keyed to 23155.
No keys included.
Please order keys
below.

PART NUMBER	DESCRIPTION	LIST PRICE
84282-001	SmartKey Key Keyed to 23155 - 4 Sets of 2 Keys Keyed Alike 8	\$20.80

Intro

Electronics

Box Pack

Visual Pack

Parts

GCD 9571	Finish Availability		GCD9571 Single Cylinder - 20 Min Fire Rated	GCD9571 Single Cylinder - 3 Hr Fire Rated
	15	Satin Nickel	9GCD95710-033	9GCD95710-034
26D	Satin Chrome	9GCD95710-037	9GCD95710-038	
List Price		\$101	\$121	
Case Quantity		12	12	



*Cylinder cap removed to show both cylinders

GCD 9571 SQT	Finish Availability		GCD9571 Single Cylinder - 20 Min Fire Rated	GCD9571 Single Cylinder - 3 Hr Fire Rated
	15	Satin Nickel	9GCD95710-035	9GCD95710-036
514	Matte Black	9GCD95710-039	9GCD95710-040	
List Price		\$101	\$121	
Case Quantity		12	12	



*Cylinder cap removed to show both cylinders

ROUND POCKET DOORLOCK	Finish Availability		WR1030 Passage	WR1031 Privacy
	11P	Venetian Bronze	9WR10300-020	9WR10310-020
15	Satin Nickel	9WR10300-016	9WR10310-016	
26	Polished Chrome	9WR10300-019	9WR10310-019	
26D	Satin Chrome	9WR10300-018	9WR10310-018	
514	Matte Black	9WR10300-021	9WR10310-021	
List Price		\$41	\$45	
Case Quantity		12	12	



SQUARE POCKET DOORLOCK	Finish Availability		W1030 Passage	W1031 Privacy
	15	Satin Nickel	9W10300-002	9W10310-009
List Price		\$41	\$45	
Case Quantity		18	18	



UPCHARGE

KEYING & STAMPING CHARGES

Master Keying - \$19.00

Construction Keying - \$19.00

Construction Master Keying - \$23.00

SmartKey Keyed Alike - \$6.00

Stamping - Per Key/Cylinder - N/C

Stamping - Do Not Copy/Duplicate - N/C

Intro

Electronics

Box Pack

Visual Pack

Parts

All Weiser product meets ASTM E 331 water penetration testing

HANDLESETS	
Door Prep	Deadbolt: Cross Bore 2-1/8" or 1-1/2" Edge Bore 1" Latch Face 1" x 2-1/4". Handle: Cross Bore 2-1/8" Edge Bore 1" Latch Face 1" x 2-1/4"
Backset	Deadbolt: Adjustable to 2-3/8" or 2-3/4" Handle: Adjustable to 2-3/8" or 2-3/4"
Door Thickness	1-3/4" doors standard. 2-1/4" doors optional Not designed for use on 1-3/8" doors
Cylinder	SmartKey standard, see specific product for more WS and KW availability
Faceplate	1" x 2-1/4". Round corner, square corner and drive-in available in box
Strikes	Deadbolt: Cross Bore 1-1/8" x 2-3/4" Round or square radius standard in box Handle: 2-1/4" full lip Round or square radius standard in box Other options available
Bolt	Deadbolt: 1" steel Handle: 1/2" throw. Nickel plated.
Door Handling	Specify handling on all curved levers. Reversible on all straight levers
ANSI/BHMA	A156.5 Grade 1 (for deadbolt)
ADA	N/A
UL	*Meets 20 minute with Square, Radius or drive-in used

KNOBS	
Door Prep	Cross Bore 2-1/8" Edge Bore 1" Latch Face 1" x 2-1/4".
Backset	Adjustable to 2-3/8" or 2-3/4" UL 2-3/4" standard 2-3/8" optional
Door Thickness	1-3/8" - 1-3/4" doors standard. 2-1/4" doors optional
Cylinder	SmartKey standard, see specific product for more WS and KW availability
Faceplate	1" x 2-1/4". Round corner, square corner and drive-in available in box
Strikes	2-1/4" full lip. Other options available
Bolt	1/2" throw. Nickel plated
Door Handling	Reversible for right or left-handed doors
ANSI/BHMA	A156.2 Grade 2
ADA	N/A
UL	Fire rating, see specific product for availability

LEVERS	
Door Prep	Cross Bore 2-1/8" Edge Bore 1" Latch Face 1" x 2-1/4".
Backset	Adjustable to 2-3/8" or 2-3/4"
Door Thickness	1-3/8" - 1-3/4" doors standard. 2-1/4" doors optional
Cylinder	SmartKey standard, see specific product for more WS and KW availability
Faceplate	1" x 2-1/4". Round corner, square corner and drive-in available in box
Strikes	2-1/4" full lip. Other options available
Bolt	1/2" throw. Nickel plated
Door Handling	Specify handing only with Inactive levers
ANSI/BHMA	A156.2 Grade 2
ADA	Functions GLA 101, GLA 12 satisfies section 4.13.9 ADA requirement.
UL	Fire rating, see specific product for availability

DEADBOLTS - GCD 9471, GD 1471	
Door Prep	Cross Bore 2-1/8" Edge Bore 1" Latch Face 1" x 2-1/4".
Backset	Adjustable to 2-3/8" or 2-3/4"
Door Thickness	SMT 1-3/8" - 1-3/4" KW P&T 1-3/4"
Cylinder	SmartKey standard, see specific product for more WS and KW availability
Faceplate	1" x 2-1/4". Round corner, square corner and drive-in available in box
Strikes	Standard: Grade 1, 1-1/8" x 2-3/4" Other options available
Bolt	1" throw. Steel.
Door Handling	Reversible for right or left-handed doors
ANSI/BHMA	A156.5 Grade 1
ADA	Interior turn piece meets 4.13.9 ADA requirements
UL	Fire rating, see specific product for availability

KEY CONTROL DEADBOLTS - GCD 9571

Door Prep	Cross Bore 2-1/8" Edge Bore 1" Latch Face 1" x 2-1/4".
Door Thickness	1-3/8" - 1-3/4"
Cylinder	2 SmartKey cylinders: 1 Standard SmartKey for users. 1 Secure new patented keyway for Key Control.
Faceplate	1" x 2-1/4"
Strikes	1-1/8" x 2-3/4"
Bolt	1" throw
ANSI/BHMA	A156.5 Grade 2
ADA	Interior turn piece meets 4.13.9 ADA requirements
UL	*Meets 3 hour fire rating for all UL functions when fronted latches used. Meets 20 minute with Square, Radius or Drive-In used. UL Ref# R10923

DEADBOLTS - GD 9471, SSD 9471

Door Prep	Cross Bore 2-1/8" or 1-1/2" Edge Bore 1" Latch Face 1" x 2-1/4".
Backset	Adjustable to 2-3/8" or 2-3/4"
Door Thickness	1-3/8" - 1-3/4" doors standard 2-1/4" doors optional
Cylinder	SmartKey standard, see specific product for more WS and KW availability
Faceplate	1" x 2-1/4". Round corner, square corner and drive-in available in box
Strikes	1-1/8" x 2-3/4" Other options available
Bolt	1" throw. Steel.
Door Handling	Reversible for right or left-handed doors
ANSI/BHMA	A156.5 Grade 2
ADA	Interior turn piece meets 4.13.9 ADA requirements
UL	Fire rating, see specific product for availability

POCKET DOOR LOCKS

Door Prep	2-1/8" Face Bore. 1" Edge Bore.
Backset	2-3/8"
Door Thickness	Adjustable for 1-3/8" or 1-3/4"
Faceplate	1" x 2-1/4" round corner. Steel. Accommodates flat and beveled doors.
Strikes	1-1/8" x 2-3/4" square corner with strike box and wood frame reinforcement. Steel. Privacy function only.
Fasteners	Standard flat or Phillips screws. #8 x 1/2" for latch, #8 x 1/2" for strike
Door Handling	Non-handed

HANDLESETS

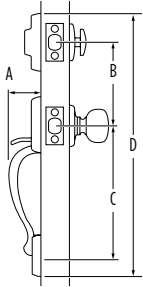

Design	A	B	C	D
Augusta	2-13/64"	5-1/2"	9-11/16"	17-45/64"
Hawthorne	2-7/8"	5-1/2"	8-13/32"	17-9/16"
Prague	2-25/32"	5-1/2"	8-13/32" through 9-11/16"	17-23/32"
Prescott	3-1/16"	5-1/2"	8-13/32" through 9-11/16"	17-13/16"

Design	A	B	C	D
San Clemente	2-5/8"	5-1/2"	8-13/32" through 9-11/16"	17-29/32"
Tavaris	2-17/32"	5-1/2"	9-11/16"	18"
Vancouver	2-21/32"	5-1/2"	8-13/32" through 9-11/16"	17-29/32"

LEVERS

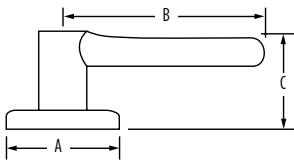

Design	A	B	C	C (Keyed)
Dane	2-5/8"	3-11/16"	2-1/2"	
Halifax (Round Rose)	2-11/16"	4-1/4"	2-1/4"	2-9/16"
Halifax (Square Rose)	2-11/16"	4-1/4"	2-1/4"	2-9/16"
Lisbon (Round Rose)	2-11/16"	4-7/32"	2-1/4"	2-9/16"
Lisbon (Square Rose)	2-11/16"	4-7/32"	2-1/4"	2-9/16"
Katella	2-11/16"	4-1/4"	2-15/32"	
Katella (Keyed)	2-11/16"	4-1/4"	2-3/8"	2-9/16"
Milan (Round Rose)	2-11/16"	4-5/32"	2-1/4"	2-9/16"
Milan (Square Rose)	2-11/16"	4-5/32"	2-1/4"	2-9/16"
Montreal (Round Rose)	2-11/16"	4-7/32"	2-1/4"	2-9/16"
Montreal (Square Rose)	2-11/16"	4-7/32"	2-1/4"	2-9/16"

Design	A	B	C	C (Keyed)
Prague	2-11/16"	4-1/4"	2-1/2"	
Perth	2-21/32"	4-1/4"	2-7/16"	2-11/32"
Sedona	2-21/32"	4-1/4"	2-17/32"	
Sedona (Keyed)	2-21/32"	4-9/32"	2-5/16"	
Singapore (Round Rose)	2-11/16"	4-7/32"	2-9/16"	
Singapore (Square Rose)	2-11/16"	4-7/32"	2-9/16"	
Sydney (Round Rose)	2-11/16"	4-1/4"	2-1/4"	2-9/16"
Sydney (Square Rose)	2-11/16"	4-1/4"	2-1/4"	2-9/16"
Toluca	2-5/8"	4-7/32"	2-3/32"	
Trafford	2-21/32"	4-5/32"	2-19/32"	2-9/16"

KNOBS

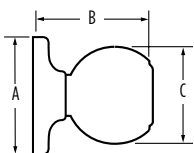

Design	A	B	C	C (Keyed)
Cambie	2-5/8"	2-13/32"	2-6/7"	
Huntington	2-5/8"	2-15/16"	2-1/8"	
Phoenix	2-5/8"	2-7/16"	2-3/16"	
Prague	2-5/8"	2-7/16"	2-3/16"	2-11/16"
Troy	2-5/8"	2-5/16"	2-1/16"	

DEADBOLTS

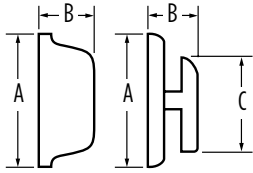

Design	A	B	C
GD 1471 Uptown Interior	2-5/8"	1-3/8"	1-21/32"
GD 1471 Uptown Exterior	2-5/8"	9/16"	N/A
GD 1471 Downtown Interior	2-5/8"	1-7/16"	1-21/32"
GD 1471 Downtown Exterior	2-5/8"	1/2"	N/A
GD 1471 Midtown Interior	2-5/8 po	1-7/16 po	1-21/32 po
GD 1471 Midtown Exterior	2-5/8 po	1/2 po	N/A
GCD 9471 Interior	2-9/16"	1-5/32"	1-13/16"
GCD 9471 Exterior	2-5/8"	1-1/16"	
GCD 9571 Interior	2-9/16"	1-5/32"	1-13/16"
GCD 9571 Exterior	3"	1-5/8"	
GD 9471	2-9/16"	1-1/16"	1-3/4"
SSD 9471 Round Interior	2-17/32"	1-13/32"	1-11/16"
SSD 9471 Round Exterior	2-17/32"	15/16"	N/A
SSD 9471 Square Interior	2-17/32"	1-13/32"	1-11/16"
SSD 9471 Square Exterior	2-19/32"	15/16"	N/A

POCKET DOORLOCKS

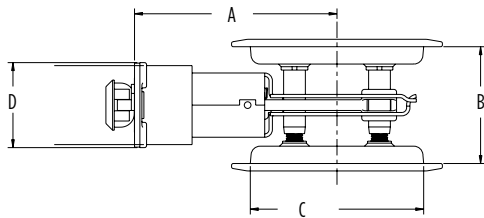

Design	A	B	C	D
Passage	2-3/8"	1-3/8" or 1-3/4"	2-1/8"	1"
Privacy	2-3/8"	1-3/8" or 1-3/4"	2-1/8"	1"

Intro

Electronics

Box Pack

Visual Pack

Parts



ELEMENTS

box pack

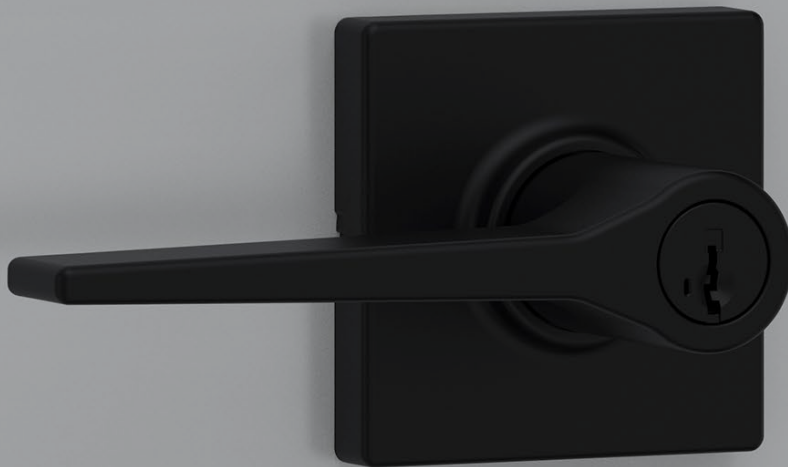

BOX PACK

ELEMENTS

HANDLESETS GROUP A	Function	GAC 9771 Single Cylinder
	List Price	\$185

AMADOR	Finish Availability	GAC9771 AMD
	15 Satin Nickel	9GAC97710-006
	26D Satin Chrome	9GAC97710-007
	514 Matte Black	9GAC97710-009
Case Quantity		6

15 Satin Nickel	9GAC97710-011	
514 Matte Black	9GAC97710-010	
Case Quantity		6

HANDLESETS GROUP B	Function	GAC 9771 Single Cylinder
	List Price	\$158

KINGSWAY	Finish Availability	GAC9771 K
	11P Venetian Bronze	9GAC97710-014
	15 Satin Nickel	9GAC97710-002
	26D Satin Chrome	9GAC97710-004
Case Quantity		6

15 Satin Nickel	9GAC97710-013	
26D Satin Chrome	9GAC97710-012	
Case Quantity		6

NOTE: All box pack handlesets are ordered LESS INTERIOR PACK (LIP). Interior packs must be ordered separately.

Intro
Electronics
Box Pack
Visual Pack
Parts

ELEMENTS

Interior Packs	Function	GAC/GLC9675 Single Cylinder	GAC/GLC9675 Single Cylinder
	List Price	\$61	\$61

ALFINI	Finish Availability		
15	Satin Nickel	9GLC96750-030	

BRETON	Finish Availability	SQUARE ROSE	ROUND ROSE
15	Satin Nickel	9GLC96750-046	9GLC96750-050
26	Polished Chrome	9GLC96750-048	9GLC96750-051
26D	Satin Chrome	9GLC96750-049	--
514	Matte Black	9GLC96750-047	9GLC96750-064

CASEY	Finish Availability	SQUARE ROSE	ROUND ROSE
15	Satin Nickel	9GLC96750-060	9GLC96750-062
514	Matte Black	9GLC96750-061	9GLC96750-063

FAIRFAX	Finish Availability		
15	Satin Nickel	9GAC96750-037	
26D	Satin Chrome	9GAC96750-038	

HENLEY	Finish Availability		
15	Satin Nickel	9GLC96750-058	
514	Matte Black	9GLC96750-059	

HOLLIS	Finish Availability	SQUARE ROSE	ROUND ROSE
15	Satin Nickel	9GLC96750-052	9GLC96750-056
26	Polished Chrome	9GLC96750-055	9GLC96750-057
26D	Satin Chrome	9GLC96750-054	--
514	Matte Black	9GLC96750-053	9GLC96750-065

KIM	Finish Availability		
15	Satin Nickel	9GLC96750-032	
26D	Satin Chrome	9GLC96750-033	

TRISTAN	Finish Availability	LEFT HANDED	RIGHT HANDED
15	Satin Nickel	9GLC96750-042	9GLC96750-043
514	Matte Black	9GLC96750-044	9GLC96750-045

ELEMENTS

LEVERS GROUP A	Function	101 Hall/Closet	331 Bed/Bath	535 Keyed Entry	12 Inactive
	List Price	\$71	\$80	\$122	\$45

BRETON - SQUARE ROSE	Finish Availability	GLC 101 BRNL	GLC 331 BRNL	GLC 535 BRNL	GLC 12 BRNL
	15 Satin Nickel	9GLC1010-062	9GLC3310-062	9GLC5350-090	9GLC120-092
	26 Polished Chrome	9GLC1010-064	9GLC3310-064	9GLC5350-092	9GLC120-094
	26D Satin Chrome	9GLC1010-065	9GLC3310-065	9GLC5350-093	9GLC120-095
	514 Matte Black	9GLC1010-063	9GLC3310-063	9GLC5350-091	9GLC120-093
Case Quantity		12	12	12	6

BRETON - ROUND ROSE	Finish Availability	GLC 101 BRNL	GLC 331 BRNL	GLC 535 BRNL	GLC 12 BRNL
	15 Satin Nickel	9GLC1010-066	9GLC3310-066	9GLC5350-113	9GLC120-096
	26 Polished Chrome	9GLC1010-067	9GLC3310-067	9GLC5350-114	9GLC120-097
	514 Matte Black	9GLC1010-092	9GLC3310-089	9GLC5350-115	9GLC120-119
Case Quantity		12	12	12	6

HENLEY	Finish Availability	GLC 101 HYL	GLC 331 HYL	GLC 535 HYL	GLC 12 HYL
	15 Satin Nickel	9GLC1010-083	9GLC3310-083	9GLC5350-107	9GLC120-113
	514 Matte Black	9GLC1010-084	9GLC3310-084	9GLC5350-108	9GLC120-114
Case Quantity		12	12	12	6

Intro
Electronics
Box Pack
Visual Pack
Parts

ELEMENTS

LEVERS GROUP B	Function	101 Hall/Closet - 20 Min Fire Rated	331 Bed/Bath	535 Keyed Entry	12 Inactive
	List Price	\$65	\$74	\$116	\$39

ALFINI	Finish Availability	GLC 101 AI	GLC 331 AI	GLC 535 AI	GLC 12 AI
	15 Satin Nickel	9GLC1010-048	9GLC3310-050	9GLC5350-082	9GLC120-071
	Case Quantity	12	12	12	6

KIM	Finish Availability	GLC 101 KML FD	GLC 331 KML	GLC 535 KML	GLC 12 KML
	15 Satin Nickel	9GLC1010-051	9GLC3310-053	9GLC5350-084	9GLC120-072
	26D Satin Chrome	9GLC1010-050	9GLC3310-052	9GLC5350-086	9GLC120-070
	Case Quantity	12	12	12	6

CASEY - SQUARE ROSE	Finish Availability	GLC 101 CSL FD	GLC 331 CSL	GLC 535 CSL	GLC 12 CSL
	15 Satin Nickel	9GLC1010-085	9GLC3310-085	9GLC5350-109	9GLC120-115
	26 Polished Chrome	9GLC1010-093	9GLC3310-091	9GLC5350-119	9GLC120-121
	514 Matte Black	9GLC1010-086	9GLC3310-086	9GLC5350-110	9GLC120-116
	Case Quantity	12	12	12	6

CASEY - ROUND ROSE	Finish Availability	GLC 101 CSL FD	GLC 331 CSL	GLC 535 CSL	GLC 12 CSL
	15 Satin Nickel	9GLC1010-087	9GLC3310-087	9GLC5350-111	9GLC120-117
	26 Polished Chrome	9GLC1010-094	9GLC3310-092	9GLC5350-120	9GLC120-122
	514 Matte Black	9GLC1010-088	9GLC3310-088	9GLC5350-112	9GLC120-118
	Case Quantity	12	12	12	6

Intro

Electronics

Box Pack

Visual Pack

Parts

ELEMENTS

LEVERS GROUP B	Function	101 Hall/Closet - 20 Min Fire Rated	331 Bed/Bath	535 Keyed Entry	12 Inactive
	List Price	\$65	\$74	\$116	\$39

HOLLIS - SQUARE ROSE	Finish Availability	GLC 101 HSL FD	GLC 331 HSL	GLC 535 HSL	GLC 12 HSL
	15 Satin Nickel	9GLC1010-075	9GLC3310-075	9GLC5350-101	9GLC120-105
	26 Polished Chrome	9GLC1010-078	9GLC3310-078	9GLC5350-104	9GLC120-108
	26D Satin Chrome	9GLC1010-077	9GLC3310-077	9GLC5350-103	9GLC120-107
	514 Matte Black	9GLC1010-076	9GLC3310-076	9GLC5350-102	9GLC120-106
Case Quantity		12	12	12	6

HOLLIS - ROUND ROSE	Finish Availability	GLC 101 HSL FD	GLC 331 HSL	GLC 535 HSL	GLC 12 HSL
	15 Satin Nickel	9GLC1010-079	9GLC3310-079	9GLC5350-116	9GLC120-109
	26 Polished Chrome	9GLC1010-080	9GLC3310-080	9GLC5350-117	9GLC120-110
	514 Matte Black	9GLC1010-089	9GLC3310-090	9GLC5350-118	9GLC120-120
	Case Quantity		12	12	12

LEVERS GROUP B	Function	101 Hall/Closet	331 Bed/Bath	535 Keyed Entry	12 Inactive LH	12 Inactive RH
	List Price	\$65	\$74	\$116	\$39	\$39

TRISTAN	Finish Availability	GLC 101 TSL	GLC 331 TSL	GLC 535 TSL	GLC 12 TSL LH	GLC TSL RH
	15 Satin Nickel	9GLC1010-060	9GLC3310-060	9GLC5350-088	9GLC120-088	9GLC120-089
	514 Matte Black	9GLC1010-061	9GLC3310-061	9GLC5350-089	9GLC120-090	9GLC120-091
	Case Quantity		12	12	12	6

Intro

Electronics

Box Pack

Visual Pack

Parts

ELEMENTS

KNOBS GROUP A	Function	101 Hall/Closet	331 Bed/Bath	531 Keyed Entry	12 Inactive
	List Price	\$42	\$51	\$77	\$24

FAIRFAX	Finish Availability	GAC 101 F	GAC 331 F	GAC 531 F	GAC 12 F
	15 Satin Nickel	9GAC1010-042	9GAC3310-037	9GAC5310-078	9GAC120-033
	26D Satin Chrome	9GAC1010-039	9GAC3310-034	9GAC5310-075	9GAC120-030
	Case Quantity	12	12	12	6

15 Satin Nickel			9GAC5310-081	
26D Satin Chrome			9GAC5310-080	
Case Quantity			12	

KNOBS GROUP B	Function	101 Hall/Closet	331 Bed/Bath	531 Keyed Entry	12 Inactive
	List Price	\$39	\$48	\$74	\$22

BEVERLY	Finish Availability	GAC 101 B	GAC 331 B	GAC 531 B	GAC 12 B
	26D Satin Chrome	9GAC1010-035	9GAC3310-030	9GAC5310-082	9GAC120-026
	Case Quantity	12	12	12	6

KNOBS GROUP C	Function	101 Hall/Closet	301 Bed/Bath	501 Keyed Entry	581 Storeroom
	List Price	\$39	\$48	\$62	\$87

BEVERLY	Finish Availability	GAC 101 B	GAC 301 B	GAC 501 B	GAC 581 B
	9 / 32D Bright Bronze/ Satin Chrome	9GAC1010-045	9GAC3010-006	9GAC5010-011	9GAC5810-005
	Case Quantity	12	12	12	12

NOTE: 9/32D uses a square spindle

Intro

Electronics

Box Pack

Visual Pack

Parts

ELEMENTS

GDC 9471



Finish Availability		GDC 9471 Single Cylinder
15	Satin Nickel	9GDC94710-068
26D	Satin Chrome	9GDC94710-070
514	Matte Black	9GDC94710-085
List Price		\$54
Case Quantity		12

GDC 9471 SQT



Finish Availability		GDC 9471 SQT Single Cylinder	GDC9471 Single Cylinder - 20 Min Fire Rated
15	Satin Nickel	--	9GDC94710-069
26	Polished Chrome	9GDC94710-084	--
26D	Satin Chrome	--	9GDC94710-071
514	Matte Black	--	9GDC94710-072
List Price		\$59	\$59
Case Quantity		12	12

15	Satin Nickel	--	9GDC94710-082
26D	Satin Chrome	--	9GDC94710-081
514	Matte Black	--	9GDC94710-079
List Price		--	\$59
Case Quantity			12



GDC 9471 RDT



Finish Availability		GDC 9471 RDT Single Cylinder	GDC9471 Single Cylinder - 20 Min Fire Rated
15	Satin Nickel	--	9GDC94710-076
26	Polished Chrome	9GDC94710-077	--
514	Matte Black	--	9GDC94710-078
List Price		\$60	\$60
Case Quantity		12	12

15	Satin Nickel	--	9GDC94710-083
514	Matte Black	--	9GDC94710-080
List Price		--	\$60
Case Quantity			12



Intro
Electronics
Box Pack
Visual Pack
Parts

ELEMENTS

UPCHARGE

KEYING & RESTAMPING CHARGES

- Master Keying - \$19.00
- Construction Keying - \$19.00
- Construction Master Keying - \$23.00
- SmartKey Keyed Alike - \$6.00
- Stamping - Per Key/Cylinder - N/C
- Stamping - Do Not Copy/Duplicate - N/C

ELEMENTS

All Elements product meets ASTM E 331 water penetration testing

HANDLESETS

Door Prep Deadbolt: Cross Bore 2-1/8" or 1-1/2" Edge Bore 1" Latch Face 1" x 2-1/4".
Handle: Cross Bore 2-1/8" Edge Bore 1" Latch Face 1" x 2-1/4"

Backset Deadbolt: Adjustable to 2-3/8" or 2-3/4"
Handle: Adjustable to 2-3/8" or 2-3/4"

Door Thickness 1-3/4" doors standard. 2-1/4" doors optional
Not designed for use on 1-3/8" doors

Cylinder SmartKey standard, see specific product for more WS and KW availability

Faceplate 1" x 2-1/4". Round corner, square corner and drive-in available in box

Strikes Deadbolt: 1-1/8" x 2-3/4"
Round or square radius standard in box
Handle: 2-1/4" full lip
Round or square radius standard in box
Other options available

Bolt Deadbolt: 1"
Handle: 1/2" throw

Door Handling Reversible for right or left-handed doors

ANSI/BHMA A156.5 Grade 3 (for deadbolt)

ADA N/A

UL Fire rating, see specific product for availability

LEVERS

Door Prep Cross Bore 2-1/8" Edge Bore 1" Latch Face 1" x 2-1/4".

Backset Adjustable to 2-3/8" or 2-3/4"
UL 2-3/4" standard 2-3/8" optional

Door Thickness 1-3/8" - 1-3/4" doors standard.
2-1/4" doors optional on GLC 101 models

Cylinder SmartKey standard, see specific product for more WS and KW availability

Faceplate 1" x 2-1/4". Round corner, square corner and drive-in available in box

Strikes 2-1/4" full lip. Other options available

Bolt 1/2" throw. Nickel plated

Door Handling Reversible for right or left-handed doors

ANSI/BHMA A156.2 Grade 3

ADA Functions GLC 101 and GLC 12 satisfy section 4.13.9. ADA requirement

UL Fire rating, see specific product for availability

KNOBS

Door Prep Cross Bore 2-1/8" Edge Bore 1" Latch Face 1" x 2-1/4".

Backset Adjustable to 2-3/8" or 2-3/4"
UL 2-3/4" standard 2-3/8" optional

Door Thickness 1-3/8" - 1-3/4" doors standard. 2-1/4" doors optional. 2-1/4" doors optional on GAC 101 models only

Cylinder SmartKey standard, see specific product for more WS and KW availability

Faceplate 1" x 2-1/4". Round corner, square corner and drive-in available in box

Strikes 2-1/4" full lip. Other options available.

Bolt 1/2" throw. Nickel plated

Door Handling Reversible for right or left-handed doors

ANSI/BHMA A156.2 Grade 3

ADA N/A

UL Fire rating, see specific product for availability

DEADBOLTS

Door Prep Cross Bore 2-1/8" Edge Bore 1" Latch Face 1" x 2-1/4".

Backset Adjustable to 2-3/8" or 2-3/4"

Door Thickness 1-3/8" - 1-3/4" doors standard

Cylinder SmartKey standard, see specific product for more WS and KW availability

Faceplate 1" x 2-1/4". Round corner, square corner and drive-in available in box

Strikes 1-1/8" x 2-3/4"

Bolt 1" throw

Door Handling Reversible for right or left-handed doors

ANSI/BHMA A156.5 Grade 3

ADA Interior turn piece meets 4.13.9 ADA requirements

UL Fire rating, see specific product for availability

ELEMENTS

HANDLESETS

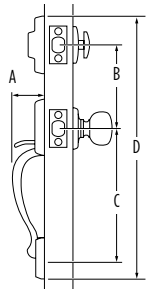

Design	A	B	C	D
Amador	2-3/32"	5-1/2"	9-11/32"	17-15/32"
Brentwood	2-1/32"	5-1/2"	8-13/32"	18-1/16"
Henley	2-5/32"	5-1/2"	8-13/32"	17-5/16"
Kingsway	2-7/32"	5-1/2"	8-13/32"	17-7/16"

LEVERS

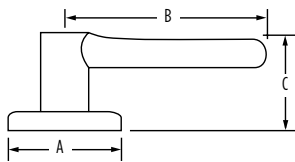

Design	A	B	C	C (Keyed)
Alfini	2-5/8"	3-3/4"	2-1/4"	2-5/8"
Belmont	2-5/8"	3-3/4"	2-1/4"	2-5/8"
Breton Square	2-5/8"	4"	2-7/16"	
Breton Round	2-5/8"	4"	2-7/16"	
Henley	2-5/8"	4-3/32"	2-9/16"	2-19/32"
Hollis Square	2-5/8"	4-4/32"	2-12/32"	
Hollis Round	2-5/8"	4-4/32"	2-12/32"	
Kim	2-5/8"	3-5/8"	1-15/16"	2-5/8"
Tristan	2-5/8"	4-7/16"	1-7/8"	2-7/16"

KNOBS

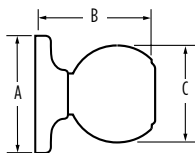

Design	A	B	C
Beverly	2-19/32"	2-7/16"	2"
Fairfax	2-5/8"	2-11/32"	1-15/16"
Yukon	2-5/8"	2-23/32"	1-7/8"

DEADBOLTS

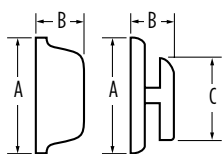

Design	A	B	C
GDC 9471	2-1/2"	1-1/8"	1-3/4"
GDC 9471 Square	2-1/2"	1-1/8"	1-3/4"
GDC 9471 Round	2-1/2"	1-1/8"	1-3/4"



SAFE LOCK

box pack

DAYLON	Function	1000 Hall/Closet	1000 Hall/Closet - 20 Min Fire Rated	1002 Hall/Closet - 3 Hr Fire Rated	3000 Bed/Bath	7000 Inactive
	List Price	\$53	\$53	\$74	\$59	\$33

DAYLON - SQUARE ROSE	Finish Availability	SL1000 DAL	SL1000 DAL	SL1002 DAL	SL3000 DAL	SL7000 DAL
	15 Satin Nickel	--	9SL10000-077	9SL10020-015	9SL30000-074	9SL70000-052
	26 Polished Chrome	9SL10000-078	--	--	9SL30000-075	9SL70000-053
	26D Satin Chrome	--	9SL10000-079	--	9SL30000-076	9SL70000-054
	514 Matte Black	--	9SL10000-081	9SL10020-020	9SL30000-078	9SL70000-056
Case Quantity		20	20	20	20	20

DAYLON - ROUND ROSE	Finish Availability	SL1000 DAL	SL1000 DAL	SL1002 DAL	SL3000 DAL	SL7000 DAL
	15 Satin Nickel	--	9SL10000-082	--	9SL30000-079	9SL70000-057
	26 Polished Chrome	9SL10000-083	--	--	9SL30000-080	9SL70000-058
	26D Satin Chrome	--	9SL10000-123	9SL10020-021	9SL30000-098	9SL70000-078
	514 Matte Black	--	9SL10000-084	--	9SL30000-081	9SL70000-059
Case Quantity		20	20	20	20	20

GRAPEVINE	Function	1000 Hall/Closet	3000 Bed/Bath	7000 Inactive
	List Price	\$46	\$53	\$25

GRAPEVINE	Finish Availability	SL1000 GV	SL3000 GV	SL7000 GV
	15 Satin Nickel	9SL10000-051	9SL30000-051	9SL70000-039
	Case Quantity	20	20	20

LAYTON	Function	1000 Hall/Closet	1002 Hall/Closet - 3 Hr Fire Rated	3000 Bed/Bath	7000 Inactive Left Handed	7000 Inactive Right Handed
	List Price	\$48	\$69	\$55	\$27	\$27

LAYTON	Finish Availability	SL1000 LY	SL1002 LY	SL3000 LY	SL7000 LY LH	SL7000 LY RH
	15 Satin Nickel	9SL10000-045	9SL10020-016	9SL30000-045	9SL70000-033	9SL70000-034
	26D Satin Chrome	9SL10000-049	9SL10020-017	9SL30000-049	9SL70000-037	9SL70000-038
	Case Quantity	20	20	20	20	20

Intro

Electronics

Box Pack

Visual Pack

Parts

WESTLEY	Function	1000 Hall/Closet	3000 Bed/Bath	7000 Inactive
	List Price	\$53	\$59	\$32

WESTLEY	Finish Availability	SL1000 WTL	SL3000 WTL	SL7000 WTL
	15 Satin Nickel	9SL10000-066	9SL30000-065	9SL70000-047
	26 Polished Chrome	9SL10000-076	9SL30000-073	9SL70000-051
	26D Satin Chrome	9SL10000-068	9SL30000-066	9SL70000-048
Case Quantity		20	20	20

WINSTON	Function	1000 Hall/Closet - 20 Min Fire Rated	1002 Hall/Closet - 3 Hr Fire Rated	3000 Bed/Bath	5000 Keyed Entry	7000 Inactive
	List Price	\$45	\$66	\$51	\$66	\$24

WINSTON	Finish Availability	SL1000 WI	SL1002 WI	SL3000 WI	SL5000 WI	SL7000 WI
	15 Satin Nickel	9SL10000-058	9SL10020-018	9SL30000-057	9SL50000-097	9SL70000-043 KW
	Case Quantity		20	20	20	20

WINSTON	Function	1000 Hall/Closet - 20 Min Fire Rated	1002 Hall/Closet - 3 Hr Fire Rated	3000 Bed/Bath	5000 Keyed Entry	7000 Inactive
	List Price	\$42	\$63	\$48	\$63	\$21

WINSTON	Finish Availability	SL1000 WI	SL1002 WI	SL3000 WI	SL5000 WI	SL7000 WI
	26D Satin Chrome	9SL10000-061	9SL10020-019	9SL30000-060	9SL50000-100	9SL70000-044 KW
	Case Quantity		20	20	20	20

Intro

Electronics

Box Pack

Visual Pack

Parts

REGINA	Function	1000 Hall/Closet	3000 Bed/Bath	5000 Keyed Entry	7000 Inactive
	List Price	\$27	\$30	\$42	\$17

Intro

REGINA	Finish Availability	SK1000RG	SK3000RG	SK5000RG	SK7000RG	KW
	15 Satin Nickel	9SK10000-040	9SK30000-040	9SK50000-057	9SK70000-022	
	Case Quantity	30	30	30	30	

Electronics

REGINA	Function	1000 Hall/Closet	3000 Bed/Bath	5000 Keyed Entry	7000 Inactive
	List Price	\$24	\$27	\$42	\$14

Box Pack

REGINA	Finish Availability	SK1000RG	SK3000RG	SK5000RG	SK7000RG	KW
	26D Satin Chrome	9SK10000-044	9SK30000-044	9SK50000-059	9SK70000-024	
	Case Quantity	30	30	30	30	

Visual Pack

Parts

	SD9102		Finish Availability		9102 Deadbolt - 3 Hr Fire Rated
	26D	Satin Chrome	9SD91020-004	KW	
	List Price		\$30		
	Case Quantity		12		

	SD9102		Finish Availability		9102 Deadbolt - 3 Hr Fire Rated
	15	Satin Nickel	9SD91020-005	KW	
	List Price		\$32		
	Case Quantity		12		

UPCHARGE

KEYING & STAMPING CHARGES

Master Keying - \$19.00

Construction Keying - \$19.00

Construction Master Keying - \$23.00

SmartKey Keyed Alike - \$6.00

Stamping - Per Key/Cylinder - N/C

Stamping - Do Not Copy/Duplicate - N/C

Intro

Electronics

Box Pack

Visual Pack

Parts

HANDLESETS

Door Prep	Deadbolt: Cross Bore 2-1/8" or 1-1/2" Edge Bore 1" Latch Face 1" x 2-1/4"	Strikes	Deadbolt: 1" x 2-1/4" Specify round corner, square corner or full lip (5303) Handle: 2-1/4" full lip Specify round corner or square corner
Backset	Deadbolt: Adjustable to 2-3/8" or 2-3/4" Handle: Adjustable to 2-3/8" or 2-3/4"	Bolt	Deadbolt: 1" throw Handle: 1/2" throw
Door Thickness	1-3/8" - 1-3/4" doors standard No thick door option	Door Handling	Non-handed
Cylinder	KW 5 pin	ANSI/BHMA	A156.5 Grade 3 Deadbolt
Faceplate	1" x 2-1/4" Specify round corner, square corner or drive-in	ADA	N/A
		UL	N/A

KNOBS

Door Prep	Cross Bore 2-1/8" Edge Bore 1" Latch Face 1" x 2-1/4"	Strikes	2-1/4" full lip. Specify round corner or square corner.
Backset	Adjustable to 2-3/8" or 2-3/4"	Bolt	1/2" throw
Door Thickness	1-3/8" - 1-3/4" doors standard No thick door option	Door Handling	Non-handed
Cylinder	KW 5 pin	ANSI/BHMA	A156.2 Grade 3
Faceplate	1" x 2-1/4" Specify round corner, square corner or drive-in	ADA	N/A
		UL	Meets UL 3 hour fire rating for all UL functions ULRef # R7860

LEVERS

Door prep	Cross Bore 2-1/8" Edge Bore 1" Latch Face 1" x 2-1/4".	Strikes	2-1/4" full lip. Specify round corner or square corner
Backset	Adjustable to 2-3/8" or 2-3/4" UL 2-3/4" standard 2-3/8" optional	Bolt	1/2" throw
Door Thickness	1-3/8" - 1-3/4" doors standard. No thick door option	ANSI/BHMA	A156.2 Grade 3
Cylinder	KW 5 pin	ADA	1000 and 7000 functions satisfy section 4.13.9 ADA requirements
Faceplate	1" x 2-1/4" Specify round corner, square corner or drive-in	UL	Meets UL 3 hour fire rating for all UL functions. ULRef # R7860. Meets 20-minute with drive-in latch

DEADBOLTS

Door Prep	Single & Double Cylinder: Cross Bore 2-1/8". Edge Bore 1" Latch Face 1" x 2-1/4" One Sided Deadbolt: Half Cross Bore 1-5/8" Edge Bore 1" Latch Face 1" x 2-1/4"	Strikes	1" x 2-1/4" Specify round corner or square corner
Backset	Adjustable to 2-3/8" or 2-3/4"	Bolt	1" throw.
Door Thickness	1-3/8" - 1-3/4" doors standard. No thick door option	Door Handling	Non-handed
Cylinder	KW 5 pin	ANSI/BHMA	A156.5 Grade 3
Faceplate	1" x 2-1/4" Specify round corner, square corner or drive-in	ADA	Interior turn piece meets 4.13.9 ADA requirements
		UL	Meets UL 3 hour fire rating for all UL functions. ULRef # 10923

LEVERS

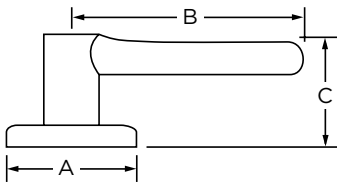

Design	A	B	C	C (Keyed)
Daylon	2-9/16"	4-3/32"	2-5/16"	
Grapevine	2-9/16"	3-3/4"	2-1/2"	2-1/2"
Layton	2-9/16"	3-5/8"	2-3/8"	2-3/8"
Westley	2-9/16"	4-3/32"	2-5/16"	
Winston	2-9/16"	3-5/8"	2-3/8"	2-3/8"

KNOBS

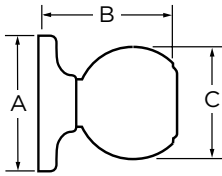

Design	A	B	C
Regina	2-9/16"	2-7/8"	1-3/4"

DEADBOLTS

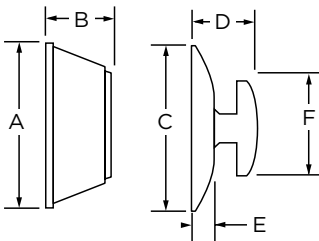

Design	A	B	C	D	E	F
Single Cylinder	2-1/2"	1-1/8"	2-9/16"	3/4"	1/4"	2-1/8"



VISUAL PACK



HANDLESETS GROUP A	Function	9471 / 8471 Single Cylinder	8471 Single Cylinder
	List Price	\$450	\$450

	SAN CLEMENTE		Finish Availability	GLA8471 SCE/HFL	GA8471 SCE/CBK
	4	Satin Brass		9GLA84710-022	
	15	Satin Nickel		9GLA84710-001	
	514	Matte Black		9GLA84710-002	9GA84710-002
					
	Interior		Halifax	Cambie	
	Case Quantity		2	2	

	VANCOUVER		Finish Availability	GLA8471 VNH/HFL
	15	Satin Nickel		9GLA84710-004
	514	Matte Black		9GLA84710-005
				
		Interior		Halifax
	Case Quantity		2	

	PRAGUE		Finish Availability	GLA8471 PGH/PGL
	15	Satin Nickel		9GLA84710-014
	514	Matte Black		9GLA84710-015
				
		Interior		Prague
	Case Quantity		2	

Intro
Electronics
Box Pack
Visual Pack
Parts

HANDLESETS GROUP B	Function	9471 Single Cylinder
	List Price	\$443

	TAVARIS		Finish Availability	GLA9471 TVH/BRNL
	15	Satin Nickel		9GLA94710-039
	514	Matte Black		9GLA94710-038
				
		Interior		Breton
		Case Quantity		2

Intro





Electronics



Box Pack

Visual Pack

Parts



HANDLESETS GROUP C	Function	9471 Single Cylinder	9471 Single Cylinder
	List Price	\$407	\$407





HAWTHORNE	Finish Availability		GLA9471 HE/TC	GA9471 HE/T
	11P	Venetian Bronze		9GA94710-043
	15	Satin Nickel	9GLA94710-013	
				
	Interior		Toluca	Troy
Case Quantity			2	2

HERITAGE	Finish Availability		GA9471 H/HT
	3BR	Lifetime Brass	9GA94710-031
	5	Antique Brass	9GA94710-034
			
	Interior		Huntington
Case Quantity			2

Intro
Electronics
Box Pack
Visual Pack
Parts

HANDLESETS GROUP C	Function	9471 Single Cylinder	9471 Single Cylinder	9471 Single Cylinder
	List Price	\$407	\$407	\$407

AUGUSTA	Finish Availability		GA9471 A/T
	514	Matte Black	9GA94710-020
			
	Interior		Troy
	Case Quantity		2

PRESCOTT	Finish Availability		GLA8471 PTH/TC	GLA8471 PTH/KAL	GLA8471 PTH/SEL
	11P	Venetian Bronze	9GLA84710-006		
	15	Satin Nickel	9GLA84710-007		9GLA84710-018
	514	Matte Black	9GLA84710-008	9GLA84710-010	9GLA84710-019
					
	Interior		Toluca	Katella	Sedona
Case Quantity		2	2	2	

**HANDLESET
MINUS**

Function	7771 Handleset Minus
List Price	\$285

HAWTHORNE



Finish Availability		GLA7771 HE/TC11P
11P	Venetian Bronze	9GLA77710-004
Interior		Toluca
Case Quantity		2



SAN CLEMENTE



Finish Availability		GLA7771 SCE/HFL
15	Satin Nickel	9GLA77710-007
514	Matte Black	9GLA77710-001
Interior		Halifax
Case Quantity		2



Intro

Electronics

Box Pack

Visual Pack

Parts

HANDLESETS MINUS	Function	7771 Handleset Minus
	List Price	\$285

TAVARIS 	Finish Availability		GLA7771 TVH/BRNL
	15	Satin Nickel	9GLA77710-009
			
	Interior		Breton
	Case Quantity		2

PRESCOTT 	Finish Availability		GLA7771 PTH/KAL
	15	Satin Nickel	9GLA77710-010
	514	Matte Black	9GLA77710-011
			
	Interior		Katella
Case Quantity		2	

LEVERS GROUP A	Function	101 Hall/Closet	331 Bed/Bath	535 Keyed Entry	12 Inactive
	List Price	\$83	\$100	\$156	\$51

Intro

HALIFAX	Finish Availability	GLA 101 HFL	GLA 331 HFL	GLA535 HFL	GLA 12 HFL
	4 Satin Brass	9GLA1010-151	9GLA3310-144	9GLA5350-185	9GLA120-137
	Case Quantity	4	4	4	4

Electronics

PERTH	Finish Availability	GLA 101 PHL	GLA 331 PHL	GLA 535 PHL
	15 Satin Nickel	9GLA1010-163	9GLA3310-156	9GLA5350-197
	514 Matte Black	9GLA1010-164	9GLA3310-157	9GLA5350-198
	Case Quantity	4	4	4

Box Pack

PRAGUE	Finish Availability	GLA 101 PGL	GLA 331 PGL	GLA 535 PGL	GLA 12 PGL
	15 Satin Nickel	9GLA1010-137	9GLA3310-136	9GLA5350-181	9GLA120-131
	514 Matte Black	9GLA1010-138	9GLA3310-137	9GLA5350-182	9GLA120-132
	Case Quantity	4	4	4	4

Visual Pack

SEDONA	Finish Availability	GLA 101 SEL	GLA 331 SEL	GLA 535 SEL
	4 Satin Brass	9GLA1010-155	9GLA3310-148	9GLA5350-189
	15 Satin Nickel	9GLA1010-153	9GLA3310-146	9GLA5350-187
	514 Matte Black	9GLA1010-154	9GLA3310-147	9GLA5350-188
	Case Quantity	4	4	4

Parts

TRAFFORD	Finish Availability	GLA 101 TDL	GLA 331 TDL	GLA 535 TDL
	15 Satin Nickel	9GLA1010-159	9GLA3310-152	9GLA5350-193
	514 Matte Black	9GLA1010-160	9GLA3310-153	9GLA5350-194
	Case Quantity	4	4	4



LEVERS GROUP B	Function	101 Hall/Closet	331 Bed/Bath	535 Keyed Entry	12 Inactive
	List Price	\$79	\$96	\$149	\$48

HALIFAX	Finish Availability	GLA 101 HFL	GLA 331 HFL	GLA535 HFL	GLA 12 HFL
	11P Venetian Bronze	9GLA1010-062	9GLA3310-061	9GLA5350-091	9GLA120-051
	15 Satin Nickel	9GLA1010-063	9GLA3310-062	9GLA5350-092	9GLA120-052
	26 Polished Chrome	9GLA1010-064	9GLA3310-063	9GLA5350-093	9GLA120-053
	514 Matte Black	9GLA1010-065	9GLA3310-064	9GLA5350-094	9GLA120-054
Case Quantity		4	4	4	4

MILAN	Finish Availability	GLA 101 MIL	GLA331 MIL	GLA 535 MIL	GLA 12 MIL
	15 Satin Nickel	9GLA1010-066	9GLA3310-065	9GLA5350-095	9GLA120-055
	26D Satin Chrome	9GLA1010-067	9GLA3310-066	9GLA5350-096	9GLA120-056
	514 Matte Black	9GLA1010-126	9GLA3310-125	9GLA5350-170	9GLA120-120
Case Quantity		4	4	4	4

LEVERS GROUP D	Function	101 Hall/Closet	331 Bed/Bath	535 Keyed Entry	12 Inactive
	List Price	\$79	\$96	\$149	\$48

	KATELLA	Finish Availability	GLA 101 KAL	GLA 331 KAL	GLA 535 KAL	GLA 12 KAL
	11P	Venetian Bronze	9GLA1010-134	9GLA3310-133	9GLA5350-178	9GLA120-128
	15	Satin Nickel	9GLA1010-132	9GLA3310-131	9GLA5350-176	9GLA120-126
	514	Matte Black	9GLA1010-133	9GLA3310-132	9GLA5350-177	9GLA120-127
	Case Quantity		12	12	12	6

LEVERS GROUP E	Function	101 Hall/Closet	331 Bed/Bath	535 Keyed Entry	12 Inactive LH	12 Inactive RH
	List Price	\$75	\$92	\$145	\$40	\$40

	TOLUCA	Finish Availability	GLA 101 TC	GLA 331 TC	GLA 535 TC	GLA 12 TC	GLA 12 TC
	11P	Venetian Bronze	9GLA1010-053	9GLA3310-052	9GLA5350-076	9GLA120-038	9GLA120-039
	15	Satin Nickel	9GLA1010-050	9GLA3310-049	9GLA5350-071	9GLA120-034	9GLA120-035
	514	Matte Black	9GLA1010-118	9GLA3310-117	9GLA5350-147	9GLA120-111	9GLA120-112
	Case Quantity		4	4	4	4	4

Intro
Electronics
Box Pack
Visual Pack
Parts

KNOB GROUP A	Function	101 Hall/Closet	331 Bed/Bath	531 Keyed Entry	12 Inactive
	List Price	\$68	\$85	\$141	\$34

PRAGUE 	Finish Availability		GLA 101 PGK	GLA 331 PGK	GLA 531 PGK	GLA 12 PGK
	15	Satin Nickel	9GA1010-153	9GA3310-156	9GA5310-211	9GA120-100
	514	Matte Black	9GA1010-154	9GA3310-157	9GA5310-212	9GA120-101
	Case Quantity		4	4	4	4

KNOB GROUP B	Function	101 Hall/Closet	331 Bed/Bath	531 Keyed Entry	12 Inactive
	List Price	\$64	\$81	\$134	\$32

CAMBIE 	Finish Availability		GA 101 CBK	GA 331 CBK	GA 531 CBK	GA 12 CBK
	15	Satin Nickel	9GA1010-147	9GA3310-150	9GA5310-188	9GA120-094
	514	Matte Black	9GA1010-148	9GA3310-151	9GA5310-189	9GA120-095
	Case Quantity		4	4	4	4

Intro

KNOBS GROUP C	Function	101 Hall/Closet	331 Bed/Bath	531 Keyed Entry	12 Inactive
	List Price	\$58	\$75	\$128	\$31

HUNTINGTON		Finish Availability	GA 101 HT	GA 331 HT	GA 531 HT	GA 12 HT
	15	Satin Nickel	9GA1010-020	9GA3310-019	9GA5310-057	9GA120-012
	26D	Satin Chrome	9GA1010-022	9GA3310-021	9GA5310-058	9GA120-013
	Case Quantity		4	4	4	4

Electronics

PHOENIX		Finish Availability	GA 101 P	GA 331 P	GA 531 P	GA 12 P
	11P	Venetian Bronze	9GA1010-015	9GA3310-014	9GA5310-054	9GA120-009
	15	Satin Nickel	9GA1010-011	9GA3310-010	9GA5310-052	9GA120-007
	Case Quantity		4	4	4	4

Box Pack

KNOBS GROUP D	Function	101 Hall/Closet	331 Bed/Bath	531 Keyed Entry	12 Inactive
	List Price	\$50	\$67	\$120	\$26

TROY		Finish Availability	GA 101 T	GA 331 T	GA 531 T	GA 12 T
	11P	Venetian Bronze	9GA1010-007	9GA3310-007	9GA5310-050	9GA120-005
	15	Satin Nickel	9GA1010-003	9GA3310-003	9GA5310-047	9GA120-002
	26D	Satin Chrome	9GA1010-006	9GA3310-006	9GA5310-049	9GA120-004
	514	Matte Black	9GA1010-009	9GA3310-009	9GA5310-051	9GA120-006
	Case Quantity		4	4	4	4

Parts

DOWNTOWN GD 1471	Finish Availability		GD 1471 SQT Single Cylinder
		4	Satin Brass
	15	Satin Nickel	9GD14710-017
	514	Matte Black	9GD14710-023
	List Price		\$111
	Case Quantity		4

UPTOWN GD 1471	Finish Availability		GD 1471 RDT Single Cylinder
		15	Satin Nickel
	514	Matte Black	9GD14710-024
	List Price		\$111
	Case Quantity		4

MIDTOWN GD 1471	Finish Availability		GD 1471 Single Cylinder
		15	Satin Nickel
	514	Matte Black	9GD14710-034
	List Price		\$111
	Case Quantity		4

GCD 9471	Finish Availability		GCD 9471 Single Cylinder Square Face Latch	GCD 9471 Single Cylinder Drive-In Latch
		15	Satin Nickel	9GCD94710-050
	514	Matte Black	9GCD94710-055	9GCD94710-054
	List Price		\$103	\$103
	Case Quantity		4	4

Intro

Electronics

Box Pack

Visual Pack

Parts

Intro

Electronics

Box Pack

Visual Pack

Parts

GD 9471	Finish Availability	GD 9471 Single Cylinder
	3BR Lifetime Brass	9GD94710-091
	11P Venetian Bronze	9GD94710-084
	15 Satin Nickel	9GD94710-087
	26D Satin Chrome	9GD94710-090
	514 Matte Black	9GD94710-085
	List Price	\$99
	Case Quantity	4

SSD 9471 SQUARE	Finish Availability	SSD 9471 SQT
	15 Satin Nickel	9SSD94710-018
	List Price	\$71
	Case Quantity	4

CAMBIE		Finish Availability	GACS741	GACS7481
			Deadbolt x Keyed Knob	Deadbolt x Passage Knob
	15	Satin Nickel	9GACS74510-025	
	514	Matte Black		9GACS74810-003
		List Price	\$185	\$119
		Case Quantity	4	4

TROY		Finish Availability	GSC7451
			Deadbolt x Keyed Knob
	26D	Satin Chrome	9GSC74510-012
		List Price	\$180
		Case Quantity	4

TOLUCA		Finish Availability	GSL7481
			Deadbolt x Passage Lever
	15	Satin Nickel	9GSL74810-001
		List Price	\$152
		Case Quantity	4

ROUND POCKET DOORLOCK



Finish Availability		WR1030 Passage	WR1031 Privacy
15	Satin Nickel	9WR10300-003	9WR10310-003
List Price		\$41	\$45
Case Quantity		6	6

SQUARE POCKET DOORLOCK



Finish Availability		W1030 Passage	W1031 Privacy
11P	Venetian Bronze	9W10300-008	9W10310-016
15	Satin Nickel	9W10300-003	9W10310-010
26D	Satin Chrome	9W10300-011	9W10310-013
List Price		\$41	\$45
Case Quantity		6	6

Intro

Electronics

Box Pack

Visual Pack

Parts





ELEMENTS

visual pack

ELEMENTS
by **WEISER**

HANDLESETS GROUP A	Function	GLC9471 Single Cylinder	GLC9471 Single Cylinder	GLC9471 Single Cylinder
	List Price	\$252	\$252	\$252





Intro



Electronics

Box Pack

Visual Pack

Parts



AMADOR	Finish Availability		GLC9471 AMD/TSL	GLC9471 AMD/CSL	GLC9471 AMD/HSL
	15	Satin Nickel	9GLC94710-019	9GLC94710-020	9GLC94710-022
	514	Matte Black	9GLC94710-018	9GLC94710-021	9GLC94710-023
					
	Interior		Tristan	Casey	Hollis
	Case Quantity		2	2	2

HENLEY	Finish Availability		GLC9471 HYH HYL
	15	Satin Nickel	9GLC94710-025
	514	Matte Black	9GLC94710-024
	Interior		Henley
	Case Quantity		2

ELEMENTS

by WEISER

HANDLESETS GROUP B	Function	9471 Single Cylinder	9471 Single Cylinder
	List Price	\$225	\$225

BRENTWOOD	Finish Availability	GLC9471 BDH/BLM	GAC9471 BDH/F
	3 Brass	9GLC94710-005	
	11P Venetian Bronze	9GLC94710-004	
	15 Satin Nickel	9GLC94710-006	9GAC94710-008
	26D Satin Chrome	9GLC94710-007	
	514 Matte Black	9GLC94710-017	
			
Interior		Belmont	Fairfax
Case Quantity		2	2

KINGSWAY	Finish Availability	GAC9471 K/F	GAC9471 K/Y
	3BR Lifetime Brass		9GAC94710-001
	11P Venetian Bronze	9GAC94710-003	
	15 Satin Nickel		9GAC94710-007
	26D Satin Chrome		9GAC94710-002
			
Interior		Fairfax	Yukon
Case Quantity		2	2

Intro

Electronics

Box Pack

Visual Pack

Parts

ELEMENTS
by **WEISER**

Intro

Electronics

Box Pack

Visual Pack

Parts

LEVERS GROUP A	Function	101 Hall/Closet	331 Bed/Bath	535 Keyed Entry	12 Inactive
	List Price	\$73	\$82	\$122	\$48

BRETON	Finish Availability	GLC 101 BRNL	GLC 331 BRNL	GLC 535 BRNL	GLC 12 BRNL
	15 Satin Nickel	9GLC1010-068	9GLC3310-068	9GLC5350-094	9GLC120-098
	26D Satin Chrome	9GLC1010-070	9GLC3310-070	9GLC5350-096	9GLC120-100
	514 Matte Black	9GLC1010-069	9GLC3310-069	9GLC5350-095	9GLC120-099
Case Quantity		4	4	4	4

HENLEY	Finish Availability	GLC 101 HYL	GLC 331 HYL	GLC 535 HYL	GLC 12 HYL
	15 Satin Nickel	9GLC1010-081	9GLC3310-081	9GLC5350-105	9GLC120-111
	514 Matte Black	9GLC1010-082	9GLC3310-082	9GLC5350-106	9GLC120-112
	Case Quantity		4	4	4

LEVERS GROUP B	Function	101 Hall/Closet	331 Bed/Bath	535 Keyed Entry	12 Inactive
	List Price	\$67	\$76	\$116	\$40

CASEY	Finish Availability	GLC 101 CSL	GLC 331 CSL	GLC 535 CSL	GLC 12 CSL
	15 Satin Nickel	9GLC1010-071	9GLC3310-071	9GLC5350-097	9GLC120-101
	514 Matte Black	9GLC1010-072	9GLC3310-072	9GLC5350-098	9GLC120-102
	Case Quantity		4	4	4

HOLLIS	Finish Availability	GLC 101 HSL	GLC 331 HSL	GLC 535 HSL	GLC 12 HSL
	15 Satin Nickel	9GLC1010-073	9GLC3310-073	9GLC5350-099	9GLC120-103
	514 Matte Black	9GLC1010-074	9GLC3310-074	9GLC5350-100	9GLC120-104
	Case Quantity		4	4	4

KIM	Finish Availability	GLC 101 KML	GLC 331 KML	GLC 535 KML	GLC 12 KML	
	26D Satin Chrome	9GLC1010-043	9GLC3310-043	9GLC5350-060	9GLC120-061	
	Case Quantity		6	6	6	4

ELEMENTS
by **WEISER**

LEVERS GROUP B	Function	101 Hall/Closet	331 Bed/Bath	535 Keyed Entry	12 Inactive LH	12 Inactive RH
	List Price	\$67	\$76	\$116	\$40	\$40

TRISTAN SQUARE ROSE		Finish Availability	GLC 101 TSL	GLC 331 TSL	GLC 535 TSL	GLC 12 TSL LH	GLC 12 TSL RH
	15	Satin Nickel	9GLC1010-058	9GLC3310-058	9GLC5350-075	9GLC120-084	9GLC120-085
	514	Matte Black	9GLC1010-059	9GLC3310-059	9GLC5350-076	9GLC120-086	9GLC120-087
	Case Quantity		6	6	6	4	4

LEVERS GROUP C	Function	101 Hall/Closet	331 Bed/Bath	535 Keyed Entry	12 Inactive LH	12 Inactive RH
	List Price	\$60	\$70	\$96	\$38	\$38

BELMONT		Finish Availability	GLC 101 BLM	GLC 331 BLM	GLC 535 BLM	GLC 12 BLM LH	GLC 12 BLM RH
	3	Brass	9GLC1010-014	9GLC3310-014	9GLC5350-031	9GLC120-013	9GLC120-018
	11P	Venetian Bronze	9GLC1010-016	9GLC3310-016	9GLC5350-033	9GLC120-015	9GLC120-020
	15	Satin Nickel	9GLC1010-017	9GLC3310-017	9GLC5350-034	9GLC120-016	9GLC120-021
	26D	Satin Chrome	9GLC1010-018	9GLC3310-018	9GLC5350-035	9GLC120-017	9GLC120-022
	514	Matte Black	9GLC1010-057	9GLC3310-057	9GLC5350-074	9GLC120-082	9GLC120-083
	Case Quantity		6	6	6	4	4

Intro

Electronics

Box Pack

Visual Pack

Parts

ELEMENTS

by/for WEISER

KNOBS GROUP A	Function	101 Hall/Closet	331 Bed/Bath	531 Keyed Entry	12 Inactive
	List Price	\$44	\$53	\$79	\$26

FAIRFAX	Finish Availability	GAC 101 F	GAC 331 F	GAC 531 F	GAC 12 F
	3 Brass	9GAC1010-004	9GAC3310-004	9GAC5310-064	9GAC120-003
	11P Venetian Bronze	9GAC1010-008	9GAC3310-008	9GAC5310-043	9GAC120-006
	15 Satin Nickel	9GAC1010-033	9GAC3310-028	9GAC5310-069	9GAC120-024
	26D Satin Chrome	9GAC1010-007	9GAC3310-007	9GAC5310-067	9GAC120-005
Case Quantity		6	6	6	6

YUKON	Finish Availability	GAC 101 Y	GAC 331 Y	GAC 531 Y	GAC 12 Y
	3 Brass	9GAC1010-009	9GAC3310-009	9GAC5310-068	9GAC120-007
	15 Satin Nickel	9GAC1010-011	9GAC3310-011	9GAC5310-046	9GAC120-008
	26D Satin Chrome	9GAC1010-013	9GAC3310-013	9GAC5310-048	9GAC120-009
Case Quantity		6	6	6	6

KNOBS GROUP B	Function	101 Hall/Closet	301 Bed/Bath	501 Keyed Entry
	List Price	\$42	\$51	\$64

BEVERLY	Finish Availability	GAC 101 B 9/32D	GAC 301 B 9/32D	GAC 501 B 9/32D
	9/32D Bright Bronze/ Satin Chrome	9GAC1010-044	9GAC3010-005	9GAC5010-010
	Case Quantity	6	6	6

Note: 9/32D uses the legacy Weiser pin & tumbler only

Intro

Electronics

Box Pack

Visual Pack

Parts



ELEMENTS
by **WEISER**

GDC 9471	Finish Availability		GDC 9471 Single Cylinder
	3BR	Lifetime Brass	9GDC94710-061
	11P	Venetian Bronze	9GDC94710-058
	15	Satin Nickel	9GDC94710-059
	26D	Satin Chrome	9GDC94710-060
	List Price		\$56
Case Quantity		6	

GDC 9471 SQT	Finish Availability		GDC9471 SQT Single Cylinder
	15	Satin Nickel	9GDC94710-062
	514	Matte Black	9GDC94710-063
	List Price		\$61
	Case Quantity		6

GDC 9471 RDT	Finish Availability		GDC9471 RDT Single Cylinder
	15	Satin Nickel	9GDC94710-073
	26D	Satin Chrome	9GDC94710-075
	514	Matte Black	9GDC94710-074
	List Price		\$62
	Case Quantity		6

Intro

Electronics

Box Pack

Visual Pack

Parts

ELEMENTS

by WEISER

Intro

BELMONT	Finish Availability	GAC7451	
		Deadbolt x Keyed Lever	
	15	Satin Nickel	9GLCS74510-002
	List Price		\$129
	Case Quantity		4

Electronics

CASEY	Finish Availability	GLC7451	
		Deadbolt x Keyed Lever	
	15	Satin Nickel	9GLCS74510-003
	514	Matte Black	9GLCS74510-005
	List Price		\$153
Case Quantity		4	

Box Pack

HOLLIS	Finish Availability	GLC7451	
		Deadbolt x Keyed Lever	
	15	Satin Nickel	9GLCS74510-004
	514	Matte Black	9GLCS74510-006
	List Price		\$153
Case Quantity		4	

Visual Pack

Parts



ELEMENTS
by **WEISER**

FAIRFAX		Finish Availability	GAC7481
			Deadbolt x Passage Knob
26D	Satin Chrome		9GACS74810-001
		List Price	\$97
		Case Quantity	4

FAIRFAX		Finish Availability	GAC7451
			Deadbolt x Keyed Knob
15	Satin Nickel		9GACS74510-018
		List Price	\$109
		Case Quantity	4

YUKON		Finish Availability	GAC7451
			Deadbolt x Keyed Knob
15	Satin Nickel		9GACS74510-022
26D	Satin Chrome		9GACS74510-021
		List Price	\$109
		Case Quantity	4

Intro

Electronics

Box Pack

Visual Pack

Parts



SAFE LOCK

visual pack

SAFE LOCK

BRANTON X WESTLEY	Function	SH1100 Single Cylinder	SH1100 Single Cylinder
	List Price	\$192	\$192

BRANTON	Finish Availability		SH1100BRNHXWTL	SH1100BRNHXREL
	15	Satin Nickel	9SH11000-022	9SH11000-025
	514	Matte Black		9SH11000-026
	Interior			
	Case Quantity		2	2

DAYTONA X REGINA	Function	SH1100 Single Cylinder	SH1100 Single Cylinder
	List Price	\$170	\$184

DAYTONA	Finish Availability		SH1100DTXRG	SH1100DTXLY
	3	Polished Brass	9SH11000-008	
	11P	Venetian Bronze		9SH11000-016
	15	Satin Nickel	9SH11000-010	9SH11000-017
	514	Matte Black	9SH11000-024	
Interior				
Case Quantity		2	2	

Intro

Electronics

Box Pack

Visual Pack

Parts

SAFE LOCK

REMINY	Function	1000 Hall/Closet	3000 Bed/Bath	5000 Keyed Entry	7000 Inactive
	List Price	\$55	\$61	\$76	\$35

REMINY	Finish Availability	SL1000REL	SL3000REL	SL5000REL	SL7000REL
	15 Satin Nickel	9SL10000-119	9SL30000-093	9SL50000-118	9SL70000-073
	514 Matte Black	9SL10000-120	9SL30000-094	9SL50000-119	9SL70000-074
	Case Quantity	6	6	6	4

WESTLEY	Function	1000 Hall/Closet	3000 Bed/Bath	5000 Keyed Entry	7000 Inactive
	List Price	\$55	\$61	\$76	\$34

WESTLEY	Finish Availability	SL1000WTL	SL3000WTL	SL5000WTL	SL7000WTL
	15 Satin Nickel	9SL10000-072	9SL30000-071	9SL50000-065	9SL70000-049
	Case Quantity	6	6	6	4

DAYLON	Function	1000 Hall/Closet	3000 Bed/Bath	5000 Keyed Entry	7000 Inactive
	List Price	\$55	\$61	\$76	\$35

DAYLON	Finish Availability	SL1000DAL	SL3000DAL	SL5000DAL	SL7000DAL
	15 Satin Nickel	9SL10000-080	9SL30000-077	9SL50000-067	9SL70000-055
	514 Matte Black	9SL10000-085	9SL30000-082	9SL50000-068	9SL70000-060
	Case Quantity	6	6	6	4

SAFE LOCK

GRAPEVINE	Function	1000 Hall/Closet	3000 Bed/Bath	5000 Keyed Entry	7000 Inactive
	List Price	\$48	\$55	\$69	\$27

GRAPEVINE	Finish Availability	SL1000GV	SL3000GV	SL5000GV	SL7000GV
	11P Venetian Bronze	9SL10000-025	9SL30000-025	9SL50000-019	9SL70000-013
	15 Satin Nickel	9SL10000-023	9SL30000-023	9SL50000-017	9SL70000-011
	514 Matte Black	9SL10000-114	9SL30000-091	9SL50000-116	9SL70000-067
Case Quantity		6	6	6	4

LAYTON	Function	1000 Hall/Closet	3000 Bed/Bath	5000 Keyed Entry	7000 Inactive LH	7000 Inactive RH
	List Price	\$50	\$57	\$71	\$29	\$29

LAYTON	Finish Availability	SL1000LY	SL3000LY	SL5000LY	SL7000LY	SL7000LY
	11P Venetian Bronze	9SL10000-033	9SL30000-033	9SL50000-026	9SL70000-021	9SL70000-022
	15 Satin Nickel	9SL10000-034	9SL30000-034	9SL50000-027	9SL70000-023	9SL70000-024
	514 Matte Black	9SL10000-115	9SL30000-092	9SL50000-117	9SL70000-068	9SL70000-069
Case Quantity		6	6	6	4	4

Intro
Electronics
Box Pack
Visual Pack
Parts

SAFE LOCK

WINSTON GROUP A	Function	1000 Hall/Closet	3000 Bed/Bath	5000 Keyed Entry	7000 Inactive
	List Price	\$55	\$61	\$76	\$35

WINSTON	Finish Availability	SL1000WI	SL3000WI	SL5000WI	SL7000WI
	15 Satin Nickel	9SL10000-112	9SL30000-089	9SL50000-114	9SL70000-065
	514 Matte Black	9SL10000-113	9SL30000-090	9SL50000-115	9SL70000-066
	Case Quantity	6	6	6	4

WINSTON GROUP B	Function	1000 Hall/Closet	3000 Bed/Bath	5000 Keyed Entry	7000 Inactive
	List Price	\$47	\$53	\$68	\$26

WINSTON	Finish Availability	SL1000WI	SL3000WI	SL5000WI	SL7000WI
	15 Satin Nickel	9SL10000-028	9SL30000-028	9SL50000-022	9SL70000-016
	Case Quantity	6	6	6	4

WINSTON GROUP C	Function	1000 Hall/Closet	3000 Bed/Bath	5000 Keyed Entry	7000 Inactive
	List Price	\$44	\$50	\$65	\$23

WINSTON	Finish Availability	SL1000WI	SL3000WI	SL5000WI	SL7000WI
	26D Satin Chrome	9SL10000-027	9SL30000-027	9SL50000-021	9SL70000-015
	Case Quantity	6	6	6	4

Intro

Electronics

Box Pack

Visual Pack

Parts

SAFE LOCK

ATHENS	Function	1000 Hall/Closet	3000 Bed/Bath	5000 Keyed Entry
	List Price	\$33	\$36	\$48

ATHENS	Finish Availability	SK1000AS	SK3000AS	SK5000AS
	11P Venetian Bronze	9SK10000-029	9SK30000-029	9SK50000-023
	Case Quantity	6	6	6

REGINA GROUP A	Function	1000 Hall/Closet	3000 Bed/Bath	5000 Keyed Entry	7000 Inactive
	List Price	\$31	\$35	\$47	\$22

REGINA	Finish Availability	SK1000RG	SK3000RG	SK5000RG	SK7000RG
	514 Matte Black	9SK10000-054	9SK30000-054	9SK50000-065	9SK70000-025
	Case Quantity	6	6	6	4

REGINA GROUP B	Function	1000 Hall/Closet	3000 Bed/Bath	5000 Keyed Entry	7000 Inactive
	List Price	\$31	\$35	\$47	\$21

REGINA	Finish Availability	SK1000RG	SK3000RG	SK5000RG	SK7000RG
	11P Venetian Bronze	9SK10000-026	9SK30000-026	9SK50000-020	9SK70000-014
	15 Satin Nickel	9SK10000-025	9SK30000-025	9SK50000-019	9SK70000-013
	Case Quantity	6	6	6	4

REGINA GROUP C	Function	1000 Hall/Closet	3000 Bed/Bath	5000 Keyed Entry	7000 Inactive
	List Price	\$28	\$32	\$44	\$19

REGINA	Finish Availability	SK1000RG	SK3000RG	SK5000RG	SK7000RG
	3 Polished Brass	9SK10000-023	9SK30000-023	9SK50000-017	9SK70000-011
	26D Satin Chrome	9SK10000-024	9SK30000-024	9SK50000-018	9SK70000-012
	Case Quantity	6	6	6	4

Intro

Electronics

Box Pack

Visual Pack

Parts

SAFE LOCK

DEADBOLT	Finish Availability		SD9100 Single Cylinder	SD9100 Single Cylinder
	3	Brass	9SD91000-011	
	11P	Venetian Bronze		9SD91000-015
	15	Satin Nickel		9SD91000-013
	26D	Satin Chrome	9SD91000-012	
	514	Matte Black		9SD91000-042
		List Price		\$38
	Case Quantity		6	6

COMBO PACK	Finish Availability		SC60000RG
 	15	Satin Nickel	9SC60000-001
		List Price	\$69
		Case Quantity	6

PARTS

SMARTKEY

PART NUMBER	DESCRIPTION	QUANTITY	LIST PRICE
800004-355	SmartKey Key Blanks	Box/50	\$130.00
900009-101	SmartKey Cut Key	1	\$4.60
800004-607	SmartKey Keys - 4 Keys Keyed Alike	4	\$10.40
84282-001	SmartKey Key Keyed to 23155 - 4 Sets of 2 Keys Keyed Alike	8	\$20.80
820231-001	Key Control Deadbolt - Control Key Blank	Each	\$5.00
900009-103	Key Control Deadbolt - Control Key Cut Key	1	\$7.00

PIN & TUMBLER

PART NUMBER	DESCRIPTION	QUANTITY	LIST PRICE
800000-125	WR5 P&T Keys	Box/50	\$130.00
900009-104	WR5 P&T Cut Key	1	\$4.60
84282-002	WR5 P&T Keys - 2 Keys Keyed Alike	2	\$5.20
83741-001	KW1 P&T Keys - 2 Keys Keyed Alike	2	\$5.20
900009-102	KW1 P&T Cut Key	1	\$4.60
810000-462	Safe Lock Key Blanks	Box/50	\$130.00
810000-434	Safe Lock Keys - 2 Keys Keyed Alike	2	\$5.20

SMARTKEY TOOLS

PART NUMBER	DESCRIPTION	QUANTITY	LIST PRICE
820062-001	Carded VP Rekey Kit (4 silver/2 brass Keys)	Each	\$30.00
83260-001	SmartKey Reset Cradle	Each	\$50.00
83282-003	SmartKey Learn Tool	Each	\$3.00
800004-351	SmartKey Learn Tool	Bag/10	\$8.00
81087-001	Emergency Tool for All Privacy Function Locksets	Box/100	\$50.00
83258-001	Reversible Lever Hex Wrench (3/32")	Each	\$6.00
83395-001	Key Control Deadbolt Rotation Tool	Each	\$8.00

SMARTKEY CYLINDERS

PART NUMBER	COMPATIBILITY	FINISH	QUANTITY	LIST PRICE
800004-527	GCD9471 Deadbolt with 2 Keys	Satin Nickel	Each	\$74.00
800004-528	GCD9471 Deadbolt with 2 Keys	Polished Chrome	Each	\$74.00
800004-529	GCD9471 Deadbolt with 2 Keys	Satin Chrome	Each	\$74.00
800004-531	GCD9471 Deadbolt with 2 Keys	Matte Black	Each	\$74.00
820028-002	Elements Deadbolt & Elements Handleset with 2 Keys	Brass	Each	\$31.00
820028-004	Elements Deadbolt & Elements Handleset with 2 Keys	Satin Nickel	Each	\$31.00
820028-007	Elements Deadbolt & Elements Handleset with 2 Keys	Satin Chrome	Each	\$31.00
820028-006	Elements Deadbolt & Elements Handleset with 2 Keys	Polished Chrome	Each	\$31.00
820028-009	Elements Deadbolt & Elements Handleset with 2 Keys	Matte Black	Each	\$31.00

SMARTKEY PLUGS

PART NUMBER	COMPATIBILITY	FINISH	QUANTITY	LIST PRICE
83025-002	GD1471 Deadbolt & 8771 Handleset with 2 Keys	Gold	Each	\$29.00
83025-001	GD1471 Deadbolt & 8771 Handleset with 2 Keys	Silver	Each	\$29.00
83025-003	GD1471 Deadbolt & 8771 Handleset with 2 Keys	Black	Each	\$29.00
820280-001	GD/SSD 9471 Deadbolt, 9771 Handleset, Aura, Halo with 2 Keys	Gold	Each	\$29.00
820280-003	GD/SSD 9471 Deadbolt, 9771 Handleset, Aura, Halo with 2 Keys	Bronze	Each	\$29.00
820280-002	GD/SSD 9471 Deadbolt, 9771 Handleset, Aura, Halo with 2 Keys	Silver	Each	\$29.00
820280-004	GD/SSD 9471 Deadbolt, 9771 Handleset, Aura, Halo with 2 Keys	Black	Each	\$29.00
800004-381	Knob/Lever/SmartCode Lever with 2 Keys	Gold	Each	\$29.00
800004-384	Knob/Lever/SmartCode Lever with 2 Keys	Bronze	Each	\$29.00
800004-382	Knob/Lever/SmartCode Lever with 2 Keys	Silver	Each	\$29.00
800004-385	Knob/Lever/SmartCode Lever with 2 Keys	Black	Each	\$29.00
84270-001	SmartCode Keypad/Touchpad, Powerbolt 3 with 2 Keys	Black	Each	\$29.00
84270-002	SmartCode Keypad/Touchpad, Powerbolt 3 with 2 Keys	Silver	Each	\$29.00

PIN & TUMBLER CYLINDERS & PLUGS

PART NUMBER	COMPATIBILITY	FINISH	QUANTITY	LIST PRICE
820313-001	WR5 Pin & Tumbler Plug - GD/SSD 9471 Deadbolt & 9771 Pin & Tumbler Handleset with 2 Keys	Gold	Each	\$31.00
820313-003	WR5 Pin & Tumbler Plug - GD/SSD 9471 Deadbolt & 9771 Pin & Tumbler Handleset with 2 Keys	Silver	Each	\$31.00
820313-008	WR5 Pin & Tumbler Plug - GD/SSD 9471 Deadbolt & 9771 Pin & Tumbler Handleset with 2 Keys	Black	Each	\$31.00
83742-001	WR5 Pin & Tumbler Full Cylinder Body - 9771 Pin & Tumbler Handleset with 2 Keys	Satin Nickel	Each	\$31.00
83742-002	WR5 Pin & Tumbler Full Cylinder Body - 9771 Pin & Tumbler Handleset with 2 Keys	Matte Black	Each	\$31.00
820312-001	KW1 Pin & Tumbler Plug - GD/SSD 9471 Deadbolt & 9771 Pin & Tumbler Handleset with 2 Keys	Gold	Each	\$31.00
820312-003	KW1 Pin & Tumbler Plug - GD/SSD 9471 Deadbolt & 9771 Pin & Tumbler Handleset with 2 Keys	Silver	Each	\$31.00
820312-008	KW1 Pin & Tumbler Plug - GD/SSD 9471 Deadbolt & 9771 Pin & Tumbler Handleset with 2 Keys	Black	Each	\$31.00
84356-001	KW1 Pin & Tumbler Full Cylinder Body - Elements by Weiser Electronic Deadbolt with 1 Key	Silver	Each	\$32.00
84356-002	KW1 Pin & Tumbler Full Cylinder Body - Elements by Weiser Electronic Deadbolt with 1 Key	Black	Each	\$32.00
810000-432	KW1 Pin & Tumbler- Safe Lock 1100 Handlesets & 9100 Deadbolts with 2 Keys	Black	Each	\$31.00
810000-433	KW1 Pin & Tumbler- Safe Lock 1100 Handlesets & 9100 Deadbolts with 2 Keys	Silver	Each	\$31.00
810000-430	KW1 Pin & Tumbler- Safe Lock Regina Knob with 2 Keys	Black	Each	\$31.00
810000-431	KW1 Pin & Tumbler- Safe Lock Regina Knob with 2 Keys	Silver	Each	\$31.00
810000-461	KW1 Pin & Tumbler- Safe Lock Levers with 2 Keys	Silver	Each	\$31.00

6-WAY ADJUSTABLE DEADBOLT LATCH

PART NUMBER	COMPATIBILITY		FINISH	QUANTITY	LIST PRICE
820317-001	8771 Handlesets & 1471 Deadbolts		Satin Nickel	Each	\$25.00
820317-002	8771 Handlesets & 1471 Deadbolts		Polished Chrome	Each	\$25.00
820317-004	8771 Handlesets & 1471 Deadbolts		Matte Black	Each	\$25.00
83750-001	1471 Deadbolts	20 Minute Fire Rated	Satin Nickel	Each	\$28.00
83750-002	1471 Deadbolts	20 Minute Fire Rated	Polished Chrome	Each	\$28.00
83750-003	1471 Deadbolts	20 Minute Fire Rated	Matte Black	Each	\$28.00
820288-004	9771 Handlesets & 9471/9571 Deadbolts		Brass	Each	\$25.00
820288-002	9771 Handlesets & 9471/9571 Deadbolts		Satin Nickel	Each	\$25.00
820288-001	9771 Handlesets & 9471/9571 Deadbolts		Polished Chrome	Each	\$25.00
820288-007	9771 Handlesets & 9471/9571 Deadbolts		Matte Black	Each	\$25.00
83708-001	9471/9571 Deadbolts	20 Minute Fire Rated	Satin Nickel	Each	\$28.00
83708-002	9471/9571 Deadbolts	20 Minute Fire Rated	Polished Chrome	Each	\$28.00
83708-003	9471/9571 Deadbolts	20 Minute Fire Rated	Matte Black	Each	\$28.00
820310-001	9771 Handlesets & 9471/9571 Deadbolts	Visual Pack	Satin Nickel	Each	\$27.00
820310-002	9771 Handlesets & 9471/9571 Deadbolts	Visual Pack	Satin Chrome	Each	\$27.00
820310-004	9771 Handlesets & 9471/9571 Deadbolts	Visual Pack	Matte Black	Each	\$27.00

SQUARE CORNER ADJUSTABLE LATCH

PART NUMBER	COMPATIBILITY		FINISH	QUANTITY	LIST PRICE
83709-001	9471/9571 Deadbolts	3 Hour Fire Rated	Satin Nickel	Each	\$31.00
83709-002	9471/9571 Deadbolts	3 Hour Fire Rated	Satin Chrome	Each	\$31.00
83709-003	9471/9571 Deadbolts	3 Hour Fire Rated	Matte Black	Each	\$31.00

5" DEADBOLT LATCH

PART NUMBER	COMPATIBILITY		FINISH	QUANTITY	LIST PRICE
820046-001	9771 Handlesets & 9471 Deadbolts		Brass	Each	\$27.00
820046-003	9771 Handlesets & 9471 Deadbolts		Polished Chrome	Each	\$27.00
820046-007	9771 Handlesets & 9471 Deadbolts		Matte Black	Each	\$27.00

Intro

Electronics

Box Pack

Visual Pack

Parts

ELECTRONIC DEADBOLT LATCH

PART NUMBER	COMPATIBILITY		FINISH	QUANTITY	LIST PRICE
84245-001	SmartCode Keypad/Touchpad, Aura, Halo/ Halo Touch - 4-Way Adjustable Latch	20 Minute Fire Rated	Matte Black	Each	\$28.00
84245-002	SmartCode Keypad/Touchpad, Aura, Halo/ Halo Touch - 4-Way Adjustable Latch	20 Minute Fire Rated	Satin Nickel	Each	\$28.00
84245-003	SmartCode Keypad/Touchpad, Aura, Halo/ Halo Touch - 4-Way Adjustable Latch	20 Minute Fire Rated	Polished Chrome	Each	\$28.00
84357-001	Elements Keypad/Powerbolt3 - 4-Way Adjustable Latch		Brass	Each	\$21.00
84357-004	Elements Keypad/Powerbolt3 - 4-Way Adjustable Latch		Venetian Bronze	Each	\$21.00
84357-002	Elements Keypad/Powerbolt3 - 4-Way Adjustable Latch		Satin Nickel	Each	\$21.00
84357-003	Elements Keypad/Powerbolt3 - 4-Way Adjustable Latch		Polished Chrome	Each	\$21.00
84357-005	Elements Keypad/Powerbolt3 - 4-Way Adjustable Latch		Matte Black	Each	\$21.00
820316-001	RAS - Tapered Square Faced Deadbolt Latch		Brass	Each	\$40.00
820316-002	RAS - Tapered Square Faced Deadbolt Latch		Venetian Bronze	Each	\$40.00
820316-003	RAS - Tapered Square Faced Deadbolt Latch		Satin Nickel	Each	\$40.00
80393-001	RAS - Tapered Drive-In Deadbolt Latch		Brass	Each	\$40.00
80393-002	RAS - Tapered Drive-In Deadbolt Latch		Venetian Bronze	Each	\$40.00
80393-003	RAS - Tapered Drive-In Deadbolt Latch		Satin Nickel	Each	\$40.00

SAFELOCK DEADBOLT LATCH

PART NUMBER	COMPATIBILITY		FINISH	QUANTITY	LIST PRICE
810000-386	1100 Handlesets & 9100 Deadbolts - Square Corner Adjustable Latch		Brass	Each	\$21.00
810000-387	1100 Handlesets & 9100 Deadbolts - Square Corner Adjustable Latch		Satin Nickel	Each	\$21.00
810000-390	1100 Handlesets & 9100 Deadbolts - Square Corner Adjustable Latch		Satin Chrome	Each	\$21.00
810000-389	1100 Handlesets & 9100 Deadbolts - Square Corner Adjustable Latch		Matte Black	Each	\$21.00
810000-381	1100 Handlesets & 9100 Deadbolts - Radius Corner Adjustable Latch		Brass	Each	\$21.00
810000-382	1100 Handlesets & 9100 Deadbolts - Radius Corner Adjustable Latch		Satin Nickel	Each	\$21.00
810000-385	1100 Handlesets & 9100 Deadbolts - Radius Corner Adjustable Latch		Satin Chrome	Each	\$21.00
810000-384	1100 Handlesets & 9100 Deadbolts - Radius Corner Adjustable Latch		Matte Black	Each	\$21.00
810000-394	1100 Handlesets & 9100 Deadbolts - Drive-In Adjustable Latch		N/A	Each	\$21.00
810000-445	9100 Deadbolts - Square Corner Adjustable Latch	3 Hour Fire Rated	Satin Nickel	Each	\$27.00
810000-446	9100 Deadbolts - Square Corner Adjustable Latch	3 Hour Fire Rated	Satin Chrome	Each	\$27.00
810000-447	9100 Deadbolts - Square Corner Adjustable Latch	3 Hour Fire Rated	Matte Black	Each	\$27.00
810000-442	9100 Deadbolts - Radius Corner Adjustable Latch	3 Hour Fire Rated	Satin Nickel	Each	\$27.00
810000-443	9100 Deadbolts - Radius Corner Adjustable Latch	3 Hour Fire Rated	Satin Chrome	Each	\$27.00
810000-444	9100 Deadbolts - Radius Corner Adjustable Latch	3 Hour Fire Rated	Matte Black	Each	\$27.00

Intro
Electronics
Box Pack
Visual Pack
Parts

6-WAY ADJUSTABLE PLAIN LATCH & KIT

PART NUMBER	COMPATIBILITY		FINISH	QUANTITY	LIST PRICE
81847-001	101/331 Knob/Lever & 9771/8771 Handlesets	Service Kit Required	N/A	Each	\$14.00
820082-003	6-Way Adjustable Plain Latch Service Kit		Satin Nickel	Each	\$9.00
820082-005	6-Way Adjustable Plain Latch Service Kit		Satin Chrome	Each	\$9.00
820082-007	6-Way Adjustable Plain Latch Service Kit		Matte Black	Each	\$9.00

6-WAY ADJUSTABLE PLAIN LATCH

PART NUMBER	COMPATIBILITY		FINISH	QUANTITY	LIST PRICE
83715-001	101/331 Knob/Lever & 9771/8771 Handlesets		Satin Nickel	Each	\$23.00
83715-002	101/331 Knob/Lever & 9771/8771 Handlesets		Satin Chrome	Each	\$23.00
83715-003	101/331 Knob/Lever & 9771/8771 Handlesets		Matte Black	Each	\$23.00
83719-001	101 Knob/Lever	20 Minute Fire Rated	Satin Nickel	Each	\$26.00
83719-002	101 Knob/Lever	20 Minute Fire Rated	Satin Chrome	Each	\$26.00
83719-003	101 Knob/Lever	20 Minute Fire Rated	Matte Black	Each	\$26.00
820004-001	101/331 Knob/Lever & 9771/8771 Handlesets	Visual Pack	Brass	Each	\$25.00
820004-002	101/331 Knob/Lever & 9771/8771 Handlesets	Visual Pack	Satin Chrome	Each	\$25.00
820004-003	101/331 Knob/Lever & 9771/8771 Handlesets	Visual Pack	Satin Nickel	Each	\$25.00
820004-004	101/331 Knob/Lever & 9771/8771 Handlesets	Visual Pack	Matte Black	Each	\$25.00

FIXED FACEPLATE PLAIN LATCH

PART NUMBER	COMPATIBILITY		FINISH	QUANTITY	LIST PRICE
820091-003	101 Knob/Lever - 2-3/4" Square Faced Plain Latch	3 Hour Fire Rated	Satin Nickel	Each	\$29.00
820091-005	101 Knob/Lever - 2-3/4" Square Faced Plain Latch	3 Hour Fire Rated	Satin Chrome	Each	\$29.00
820091-006	101 Knob/Lever - 2-3/4" Square Faced Plain Latch	3 Hour Fire Rated	Matte Black	Each	\$29.00
820090-003	101 Knob/Lever - 2-3/8" Square Faced Plain Latch	3 Hour Fire Rated	Satin Nickel	Each	\$29.00
820090-005	101 Knob/Lever - 2-3/8" Square Faced Plain Latch	3 Hour Fire Rated	Satin Chrome	Each	\$29.00
820090-006	101 Knob/Lever - 2-3/8" Square Faced Plain Latch	3 Hour Fire Rated	Matte Black	Each	\$29.00

PL-DL LATCHES

SAFELOCK PLAIN LATCH

PART NUMBER	COMPATIBILITY		FINISH	QUANTITY	LIST PRICE
810000-435	6-Way Adjustable Plain Latch - 1000/3000 Knob/Lever & 1100 Handlesets		Satin Chrome	Each	\$19.00
810000-436	6-Way Adjustable Plain Latch - 1000/3000 Knob/Lever & 1100 Handlesets		Satin Nickel	Each	\$19.00
810000-437	6-Way Adjustable Plain Latch - 1000/3000 Knob/Lever & 1100 Handlesets		Matte Black	Each	\$19.00
810000-448	4-Way Adjustable Plain Latch - 1000 Knob/Lever	20 Minute Fire Rated	Satin Nickel	Each	\$22.00
810000-449	4-Way Adjustable Plain Latch - 1000 Knob/Lever	20 Minute Fire Rated	Satin Chrome	Each	\$22.00
810000-450	4-Way Adjustable Plain Latch - 1000 Knob/Lever	20 Minute Fire Rated	Matte Black	Each	\$22.00

SAFELOCK FIXED FACEPLATE LATCH

PART NUMBER	COMPATIBILITY		FINISH	QUANTITY	LIST PRICE
810000-454	Square Corner Plain Latch - 1000 Knob/Lever	3 Hour Fire Rated	Satin Nickel	Each	\$25.00
810000-455	Square Corner Plain Latch - 1000 Knob/Lever	3 Hour Fire Rated	Polished Chrome	Each	\$25.00
810000-456	Square Corner Plain Latch - 1000 Knob/Lever	3 Hour Fire Rated	Matte Black	Each	\$25.00
810000-451	Radius Corner Plain Latch - 1000 Knob/Lever	3 Hour Fire Rated	Satin Nickel	Each	\$25.00
810000-452	Radius Corner Plain Latch - 1000 Knob/Lever	3 Hour Fire Rated	Polished Chrome	Each	\$25.00
810000-453	Radius Corner Plain Latch - 1000 Knob/Lever	3 Hour Fire Rated	Matte Black	Each	\$25.00

6-WAY ADJUSTABLE DEAD LATCH & KIT

PART NUMBER	COMPATIBILITY		FINISH	QUANTITY	LIST PRICE
81846-001	531/535/581 Knob/Lever	Service Kit Required	N/A	Each	\$16.00
820081-001	6-Way Adjustable Dead Latch Service Kit		Brass	Each	\$9.00
820081-003	6-Way Adjustable Dead Latch Service Kit		Satin Nickel	Each	\$9.00
820081-005	6-Way Adjustable Dead Latch Service Kit		Satin Chrome	Each	\$9.00
820081-007	6-Way Adjustable Dead Latch Service Kit		Matte Black	Each	\$9.00

6-WAY ADJUSTABLE DEAD LATCH

PART NUMBER	COMPATIBILITY		FINISH	QUANTITY	LIST PRICE
83718-001	531/535/581 Knob/Lever, SmartCode Lever, SmartCode Commercial Lever	20 Minute Fire Rated	Satin Nickel	Each	\$28.00
83718-002	531/535/581 Knob/Lever, SmartCode Lever, SmartCode Commercial Lever	20 Minute Fire Rated	Satin Chrome	Each	\$28.00
83718-003	531/535/581 Knob/Lever, SmartCode Lever, SmartCode Commercial Lever	20 Minute Fire Rated	Matte Black	Each	\$28.00
820003-001	531/535/581 Knob/Lever, SmartCode Lever, SmartCode Commercial Lever	Visual Pack	Brass	Each	\$27.00
820003-002	531/535/581 Knob/Lever, SmartCode Lever, SmartCode Commercial Lever	Visual Pack	Satin Chrome	Each	\$27.00
820003-003	531/535/581 Knob/Lever, SmartCode Lever, SmartCode Commercial Lever	Visual Pack	Satin Nickel	Each	\$27.00
820003-004	531/535/581 Knob/Lever, SmartCode Lever, SmartCode Commercial Lever	Visual Pack	Matte Black	Each	\$27.00

FIXED FACEPLATE DEAD LATCH

PART NUMBER	COMPATIBILITY		FINISH	QUANTITY	LIST PRICE
83717-001	531/535/581 Knob/Lever - 2-3/4" Square Faced Dead Latch	3 Hour Fire Rated	Satin Nickel	Each	\$31.00
83717-002	531/535/581 Knob/Lever - 2-3/4" Square Faced Dead Latch	3 Hour Fire Rated	Satin Chrome	Each	\$31.00
83717-003	531/535/581 Knob/Lever - 2-3/4" Square Faced Dead Latch	3 Hour Fire Rated	Matte Black	Each	\$31.00
83716-001	531/535/581 Knob/Lever - 2-3/8" Square Faced Dead Latch	3 Hour Fire Rated	Satin Nickel	Each	\$31.00
83716-002	531/535/581 Knob/Lever - 2-3/8" Square Faced Dead Latch	3 Hour Fire Rated	Satin Chrome	Each	\$31.00
83716-003	531/535/581 Knob/Lever - 2-3/8" Square Faced Dead Latch	3 Hour Fire Rated	Matte Black	Each	\$31.00

SAFELOCK DEAD LATCH

PART NUMBER	COMPATIBILITY	FINISH	QUANTITY	LIST PRICE
810000-439	5000 Knob/Lever	Satin Nickel	Each	\$21.00
810000-438	5000 Knob/Lever	Satin Chrome	Each	\$21.00
810000-440	5000 Knob/Lever	Matte Black	Each	\$21.00

PL-DL LATCHES

5" DEAD LATCH

PART NUMBER	COMPATIBILITY	FINISH	QUANTITY	LIST PRICE
820061-001	531/535/581 Knob/Lever	Brass	Each	\$25.00
820061-003	531/535/581 Knob/Lever	Satin Chrome	Each	\$25.00
820061-004	531/535/581 Knob/Lever	Matte Black	Each	\$25.00

GATELATCH

PART NUMBER	COMPATIBILITY	FINISH	QUANTITY	LIST PRICE
820234-001	9471 Deadbolt - 2-3/4" Square Faced Gate Latch	Brass	Each	\$45.00
820234-004	9471 Deadbolt - 2-3/4" Square Faced Gate Latch	Satin Chrome	Each	\$45.00
820233-004	9471 Deadbolt - 2-3/8" Square Faced Gate Latch	Satin Chrome	Each	\$45.00

GATELATCH HOLDBACK KIT

PART NUMBER	COMPATIBILITY	FINISH	QUANTITY	LIST PRICE
820236-001	9471 Deadbolt - 2-3/4" Square Faced Holdback Kit	Brass	Each	\$80.00
820236-003	9471 Deadbolt - 2-3/4" Square Faced Holdback Kit	Satin Nickel	Each	\$80.00
820236-004	9471 Deadbolt - 2-3/4" Square Faced Holdback Kit	Satin Chrome	Each	\$80.00
820235-001	9471 Deadbolt - 2-3/8" Square Faced Holdback Kit	Brass	Each	\$80.00
820235-003	9471 Deadbolt - 2-3/8" Square Faced Holdback Kit	Satin Nickel	Each	\$80.00
820235-004	9471 Deadbolt - 2-3/8" Square Faced Holdback Kit	Satin Chrome	Each	\$80.00

DEADBOLT STRIKES

PART NUMBER	DESCRIPTION	COMPATIBILITY	FINISH	QUANTITY	LIST PRICE
820049-005	Deadbolt, 4 Hole Strike, Square Corner	Standard deadbolt strike on all deadbolts and handlesets - Square Corner	Satin Nickel	Each	\$11.00
820049-003	Deadbolt, 4 Hole Strike, Square Corner	Standard deadbolt strike on all deadbolts and handlesets - Square Corner	Satin Chrome	Each	\$11.00
820049-007	Deadbolt, 4 Hole Strike, Square Corner	Standard deadbolt strike on all deadbolts and handlesets - Square Corner	Matte Black	Each	\$11.00
820050-005	Deadbolt, 4 Hole Strike, Radius Corner	Standard deadbolt strike on all deadbolts and handlesets - Radius Corner	Satin Nickel	Each	\$11.00
820050-003	Deadbolt, 4 Hole Strike, Radius Corner	Standard deadbolt strike on all deadbolts and handlesets - Radius Corner	Satin Chrome	Each	\$11.00
820050-004	Deadbolt, 4 Hole Strike, Radius Corner	Standard deadbolt strike on all deadbolts and handlesets - Radius Corner	Matte Black	Each	\$11.00
84248-003	Deadbolt, 4 Hole Strike, Square Corner with Screw Pack	SmartCode Keypad/Touchpad, Aura/Halo/Halo Touch with Screw Pack - Square Corner	Satin Nickel	Each	\$11.00
84248-002	Deadbolt, 4 Hole Strike, Square Corner with Screw Pack	SmartCode Keypad/Touchpad, Aura/Halo/Halo Touch with Screw Pack - Square Corner	Satin Chrome	Each	\$11.00
84248-001	Deadbolt, 4 Hole Strike, Square Corner with Screw Pack	SmartCode Keypad/Touchpad, Aura/Halo/Halo Touch with Screw Pack - Square Corner	Matte Black	Each	\$11.00
84358-001	Deadbolt, 2 Hole Strike	Elements Keypad/Powerbolt3 - Square Corner	Brass	Each	\$11.00
84358-004	Deadbolt, 2 Hole Strike	Elements Keypad/Powerbolt3 - Square Corner	Bronze	Each	\$11.00
84358-003	Deadbolt, 2 Hole Strike	Elements Keypad/Powerbolt3 - Square Corner	Satin Nickel	Each	\$11.00
84358-002	Deadbolt, 2 Hole Strike	Elements Keypad/Powerbolt3 - Square Corner	Satin Chrome	Each	\$11.00
84358-005	Deadbolt, 2 Hole Strike	Elements Keypad/Powerbolt3 - Square Corner	Matte Black	Each	\$11.00

Intro

Electronics

Box Pack

Visual Pack

Parts

DEADBOLT STRIKES

PART NUMBER	DESCRIPTION	FINISH	QUANTITY	LIST PRICE
85278-020	Deadbolt, 1-1/8" x 2- 3/4", Square Corner	Satin Nickel	Each	\$11.00
85278-021	Deadbolt, 1-1/8" x 2- 3/4", Square Corner	Satin Chrome	Each	\$11.00
85278-019	Deadbolt, 1-1/8" x 2- 3/4", Square Corner	Matte Black	Each	\$11.00
85279-009	Deadbolt, 1-1/8" x 2- 3/4", Radius Corner	Satin Nickel	Each	\$11.00
85279-002	Deadbolt, 1-1/8" x 2- 3/4", Radius Corner	Satin Chrome	Each	\$11.00
85279-015	Deadbolt, 1-1/8" x 2- 3/4", Radius Corner	Matte Black	Each	\$11.00
84638-008	Deadbolt, Full Lip Square Corner	Satin Nickel	Each	\$11.00
84638-002	Deadbolt, Full Lip Square Corner	Satin Chrome	Each	\$11.00
84638-010	Deadbolt, Full Lip Square Corner	Matte Black	Each	\$11.00
85303-018	Deadbolt, Full Lip Radius Corner	Satin Nickel	Each	\$11.00
85303-016	Deadbolt, Full Lip Radius Corner	Satin Chrome	Each	\$11.00
85303-017	Deadbolt, Full Lip Radius Corner	Matte Black	Each	\$11.00
85072-019	Deadbolt 1"x 2-1/4", Square Corner	Satin Nickel	Each	\$11.00
85072-004	Deadbolt 1"x 2-1/4", Square Corner	Satin Chrome	Each	\$11.00
85072-018	Deadbolt 1"x 2-1/4", Square Corner	Matte Black	Each	\$11.00
85063-014	Deadbolt 1"x 2-1/4", Radius Corner	Satin Nickel	Each	\$11.00
85063-013	Deadbolt 1"x 2-1/4", Radius Corner	Satin Chrome	Each	\$11.00
85063-008	Deadbolt 1"x 2-1/4", Radius Corner	Matte Black	Each	\$11.00
84632-005	T Strike	Satin Nickel	Each	\$11.00
84632-002	T Strike	Satin Chrome	Each	\$11.00
84632-007	T Strike	Matte Black	Each	\$11.00

Intro
Electronics
Box Pack
Visual Pack
Parts

PLAIN LATCH STRIKES

PART NUMBER	DESCRIPTION	COMPATIBILITY	FINISH	QUANTITY	LIST PRICE
83437-048	Full Lip Square Corner Standard on Non-UL Locksets	Standard strike on all levers and knobs - Square Corner	Brass	Each	\$11.00
83437-045	Full Lip Square Corner Standard on Non-UL Locksets	Standard strike on all levers and knobs - Square Corner	Satin Nickel	Each	\$11.00
83437-036	Full Lip Square Corner Standard on Non-UL Locksets	Standard strike on all levers and knobs - Square Corner	Satin Chrome	Each	\$11.00
83437-040	Full Lip Square Corner Standard on Non-UL Locksets	Standard strike on all levers and knobs - Square Corner	Matte Black	Each	\$11.00
83536-003	Full Lip Radius Corner Standard on Non-UL Locksets	Standard strike on all levers and knobs - Radius Corner	Satin Nickel	Each	\$11.00
83536-002	Full Lip Radius Corner Standard on Non-UL Locksets	Standard strike on all levers and knobs - Radius Corner	Satin Chrome	Each	\$11.00
83536-005	Full Lip Radius Corner Standard on Non-UL Locksets	Standard strike on all levers and knobs - Radius Corner	Matte Black	Each	\$11.00
83030-005	Full Lip Square Corner Strike, UL Option	UL Standard strike on all levers and knobs - Square Corner	Satin Nickel	Each	\$11.00
83030-003	Full Lip Square Corner Strike, UL Option	UL Standard strike on all levers and knobs - Square Corner	Satin Chrome	Each	\$11.00
83030-007	Full Lip Square Corner Strike, UL Option	UL Standard strike on all levers and knobs - Square Corner	Matte Black	Each	\$11.00
83031-005	Full Lip Radius Corner Strike, UL Option	UL Standard strike on all levers and knobs - Radius Corner	Satin Nickel	Each	\$11.00
83031-003	Full Lip Radius Corner Strike, UL Option	UL Standard strike on all levers and knobs - Radius Corner	Satin Chrome	Each	\$11.00
83031-007	Full Lip Radius Corner Strike, UL Option	UL Standard strike on all levers and knobs - Radius Corner	Matte Black	Each	\$11.00

Intro

Electronics

Box Pack

Visual Pack

Parts

PLAIN LATCH STRIKES

PART NUMBER	DESCRIPTION	FINISH	QUANTITY	LIST PRICE
83437-047	Full Lip 1/4" Square Corner	Brass	Each	\$11.00
83796-021	Full Lip 1/4" Radius Corner	Brass	Each	\$11.00
83796-022	Full Lip 1/4" Radius Corner	Satin Nickel	Each	\$11.00
83796-011	Full Lip 1/4" Radius Corner	Satin Chrome	Each	\$11.00
83796-019	Full Lip 1/4" Radius Corner	Matte Black	Each	\$11.00
83537-003	Extended Lip Strike Square Corner	Satin Nickel	Each	\$11.00
83537-002	Extended Lip Strike Square Corner	Polished Chrome	Each	\$11.00
83537-004	Extended Lip Strike Square Corner	Matte Black	Each	\$11.00
83846-015	ASA Strike	Satin Nickel	Each	\$11.00
83846-004	ASA Strike	Satin Chrome	Each	\$11.00
83846-017	ASA Strike	Matte Black	Each	\$11.00
83028-024	T Strike	Brass	Each	\$11.00
83028-019	T Strike	Satin Nickel	Each	\$11.00
83028-010	T Strike	Satin Chrome	Each	\$11.00
83028-023	T Strike	Matte Black	Each	\$11.00
83288-001	Box for 83028 T Strike	N/A	Each	\$11.00
81231-001	Box for Full Lip Strike	N/A	Each	\$11.00

Intro

Electronics

Box Pack

Visual Pack

Parts

P&T REKEYING SUPPLIES

PART NUMBER	DESCRIPTION	QUANTITY	LIST PRICE
81467-003	Cylinder Removal Tool	Each	\$6.00
80049-001	Key Stop Gauge	Each	\$22.00
80152-001	Plug Follower Tool	Each	\$25.00
83100-001	KW1 P&T #1 BOTTOM PIN .172"	Bag/100	\$12.00
83101-001	KW1 P&T #2 BOTTOM PIN .195"	Bag/100	\$12.00
83103-001	KW1 P&T #3 BOTTOM PIN .218"	Bag/100	\$12.00
83105-001	KW1 P&T #4 BOTTOM PIN .241"	Bag/100	\$12.00
83106-001	KW1 P&T #5 BOTTOM PIN .264"	Bag/100	\$12.00
83107-001	KW1 P&T #6 BOTTOM PIN .287"	Bag/100	\$12.00
83108-001	KW1 P&T #1 MASTER PIN .023"	Bag/100	\$12.00
83110-001	KW1 P&T #2 MASTER PIN .046"	Bag/100	\$12.00
83112-001	KW1 P&T #3 MASTER PIN .069"	Bag/100	\$12.00
83113-001	KW1 P&T #4 MASTER PIN .092"	Bag/100	\$12.00
83114-001	KW1 P&T #5 MASTER PIN .115"	Bag/100	\$12.00
83125-001	KW1 P&T #6 MASTER PIN .138"	Bag/100	\$12.00
81858-001	KW1 P&T REGULAR TOP PIN .180"	Bag/100	\$12.00
83117-001	KW1 P&T PK TOP PIN .160"	Bag/100	\$12.00
82208-001	KW1 P&T PK Balls	Bag/100	\$12.00
81777-001	KW1 P&T Tumbler Spring	Bag/100	\$12.00
84345-001	Knob Plug Retainer Clip	Bag/100	\$12.00
84215-001	Deadlock Plug Retainer Clip	Bag/100	\$12.00
87809-001	Locking Bar	Bag/100	\$12.00
85757-001	Spring Cover	Bag/50	\$6.00
87632-001	Spring	Bag/100	\$12.00
800000-041	WR5 Cylinder Cap Tool	Each	\$12.00
800000-126	WR5 P&T UNIV TOP PINS	Bag/100	\$12.00
800000-136	WR5 P&T #0 BOTTOM PINS	Bag/100	\$12.00
800000-127	WR5 P&T #1 BOTTOM PINS	Bag/100	\$12.00
800000-128	WR5 P&T #2 BOTTOM PINS	Bag/100	\$12.00
800000-129	WR5 P&T #3 BOTTOM PINS	Bag/100	\$12.00
800000-130	WR5 P&T #4 BOTTOM PINS	Bag/100	\$12.00
800000-131	WR5 P&T #5 BOTTOM PINS	Bag/100	\$12.00
800000-132	WR5 P&T #6 BOTTOM PINS	Bag/100	\$12.00
800000-133	WR5 P&T #7 BOTTOM PINS	Bag/100	\$12.00
800000-134	WR5 P&T #8 BOTTOM PINS	Bag/100	\$12.00
800000-135	WR5 P&T #9 BOTTOM PINS	Bag/100	\$12.00
800000-167	WR5 P&T #2 MASTER WAFER	Bag/100	\$12.00
800000-168	WR5 P&T #3 MASTER WAFER	Bag/100	\$12.00
800000-169	WR5 P&T #4 MASTER WAFER	Bag/100	\$12.00
800000-172	WR5 P&T #7 MASTER WAFER	Bag/100	\$12.00
800000-173	WR5 P&T #8 MASTER WAFER	Bag/100	\$12.00

DEADBOLT SCREW PACKS

PART NUMBER	COMPATIBILITY	FINISH	QUANTITY	LIST PRICE
83015-002	GD 1471 Deadbolt Screw Pack	Satin Nickel	Each	\$10.00
83015-001	GD 1471 Deadbolt Screw Pack	Satin Chrome	Each	\$10.00
83015-003	GD 1471 Deadbolt Screw Pack	Matte Black	Each	\$10.00
81247-006	GCD 9471 Deadbolt Screw Pack	Satin Nickel	Each	\$10.00
81247-001	GCD 9471 Deadbolt Screw Pack	Satin Chrome	Each	\$10.00
81247-008	GCD 9471 Deadbolt Screw Pack	Matte Black	Each	\$10.00
820083-001	GD 9471 Deadbolt Screw Pack	Brass	Each	\$10.00
820083-003	GD 9471 Deadbolt Screw Pack	Satin Nickel	Each	\$10.00
820083-002	GD 9471 Deadbolt Screw Pack	Satin Chrome	Each	\$10.00
820083-004	GD 9471 Deadbolt Screw Pack	Matte Black	Each	\$10.00
820285-002	SSD 9471 Deadbolt Screw Pack	Satin Nickel	Each	\$10.00
820285-001	SSD 9471 Deadbolt Screw Pack	Satin Chrome	Each	\$10.00
820285-003	SSD 9471 Deadbolt Screw Pack	Matte Black	Each	\$10.00
86171-003	GDC 9471 Deadbolt Screw Pack	Satin Nickel	Each	\$10.00
86171-002	GDC 9471 Deadbolt Screw Pack	Satin Chrome	Each	\$10.00
86171-004	GDC 9471 Deadbolt Screw Pack	Matte Black	Each	\$10.00
83393-003	Key Control Deadbolt Security Mounting Screws	Satin Nickel	Each	\$10.00
83393-002	Key Control Deadbolt Security Mounting Screws	Polished Chrome	Each	\$10.00
83393-004	Key Control Deadbolt Security Mounting Screws	Matte Black	Each	\$10.00
83390-002	Key Control Deadbolt Mounting Screws	Satin Nickel	Each	\$10.00
83390-003	Key Control Deadbolt Mounting Screws	Satin Chrome	Each	\$10.00

Intro
Electronics
Box Pack
Visual Pack
Parts

HANDLESET SCREW PACKS

PART NUMBER	COMPATIBILITY	FINISH	QUANTITY	LIST PRICE
83725-001	Handleset Deadbolt Mounting Screws	Satin Nickel	Each	\$10.00
83725-002	Handleset Deadbolt Mounting Screws	Polished Chrome	Each	\$10.00
83725-003	Handleset Deadbolt Mounting Screws	Matte Black	Each	\$10.00
83721-002	Elements Handleset Mounting Screws	Satin Nickel	Each	\$10.00
83721-003	Elements Handleset Mounting Screws	Satin Chrome	Each	\$10.00
83721-001	Elements Handleset Mounting Screws	Matte Black	Each	\$10.00
82213-002	Handleset Bottom Screw & Washer - Ashfield/Avalon	N/A	Each	\$10.00
83004-001	Handleset Bottom Screw & Washer - Weiser Portfolio	Silver	Each	\$10.00
81696-002	Contemporary Handleset Interior Screw Cap Cover	Satin Nickel	Each	\$10.00
81696-003	Contemporary Handleset Interior Screw Cap Cover	Satin Chrome	Each	\$10.00
81696-005	Contemporary Handleset Interior Screw Cap Cover	Matte Black	Each	\$10.00
82215-003	Decorative Handleset Interior Screw Cap Cover	Satin Nickel	Each	\$10.00
82215-005	Decorative Handleset Interior Screw Cap Cover	Polished Chrome	Each	\$10.00
82215-006	Decorative Handleset Interior Screw Cap Cover	Satin Chrome	Each	\$10.00
82215-010	Decorative Handleset Interior Screw Cap Cover	Matte Black	Each	\$10.00
88322-009	Elements Handleset Bottom Sex Nut & Wood Screw	Satin Nickel	Each	\$10.00

KNOB & LEVER SCREW PACKS

PART NUMBER	COMPATIBILITY	FINISH	QUANTITY	LIST PRICE
85201-003	Passage, Privacy, Entry & Interior Pack Chassis Screws for Knob/Levers - Weiser Portfolio	Satin Brass	Each	\$10.00
85201-001	Passage, Privacy, Entry & Interior Pack Chassis Screws for Knob/Levers - Weiser Portfolio	Satin Nickel	Each	\$10.00
85201-002	Passage, Privacy, Entry & Interior Pack Chassis Screws for Knob/Levers - Weiser Portfolio	Matte Black	Each	\$10.00
89930-003	Passage, Privacy, Entry & Interior Pack Chassis Screws for Contemporary Levers - Weiser Portfolio	Satin Nickel	Each	\$10.00
89930-001	Passage, Privacy, Entry & Interior Pack Chassis Screws for Contemporary Levers - Weiser Portfolio	Satin Chrome	Each	\$10.00
89930-002	Passage, Privacy, Entry & Interior Pack Chassis Screws for Contemporary Levers - Weiser Portfolio	Matte Black	Each	\$10.00
86151-008	Elements Inner Trim Knob/Lever Screws Pack	Gold	Each	\$10.00
86151-007	Elements Inner Trim Knob/Lever Screws Pack	Silver	Each	\$10.00
86151-006	Elements Inner Trim Knob/Lever Screws Pack	Black	Each	\$10.00
81711-001	Knob/Lever Strike/Latch Screw Pack	Brass	Each	\$10.00
81711-002	Knob/Lever Strike/Latch Screw Pack	Satin Nickel	Each	\$10.00
81711-004	Knob/Lever Strike/Latch Screw Pack	Matte Black	Each	\$10.00

INACTIVE/DUMMY SCREW PACKS

PART NUMBER	COMPATIBILITY	FINISH	QUANTITY	LIST PRICE
83751-002	Dummy Surface Mounting Screws for Levers/Knobs	Satin Nickel	Each	\$10.00
83751-001	Dummy Surface Mounting Screws for Levers/Knobs	Matte Black	Each	\$10.00
89932-003	Dummy Surface Mounting Screws for Contemporary Levers - Weiser Portfolio	Satin Nickel	Each	\$10.00
89932-001	Dummy Surface Mounting Screws for Contemporary Levers - Weiser Portfolio	Satin Chrome	Each	\$10.00
89932-002	Dummy Surface Mounting Screws for Contemporary Levers - Weiser Portfolio	Matte Black	Each	\$10.00
83726-002	Dummy Thru-Bolt Mounting Screws	Satin Nickel	Each	\$10.00
83726-001	Dummy Thru-Bolt Mounting Screws	Matte Black	Each	\$10.00

Intro
Electronics
Box Pack
Visual Pack
Parts

SET SCREW PACKS

PART NUMBER	COMPATIBILITY	QUANTITY	LIST PRICE
83257-001	Exterior Entry SMT Set Screw	Each	\$10.00
83255-001	Interior Entry Pin & Tumbler Entry Set Screw	Each	\$10.00
83256-001	Exterior Entry Pin & Tumbler Entry Set Screw	Each	\$10.00
83254-001	Passage/Privacy/Interior Entry Set Screw	Each	\$10.00

ELECTRONIC SCREW PACKS

PART NUMBER	COMPATIBILITY	FINISH	QUANTITY	LIST PRICE
84252-001	SmartCode Keypad/Touchpad - Interior Chassis Mounting Screws	N/A	Each	\$10.00
84250-001	SmartCode Keypad/Touchpad -Mounting Screws	N/A	Each	\$10.00
84354-001	Powerbolt 3 & Elements by Weiser Electronic Deadbolt - Mounting Screws	N/A	Each	\$10.00
84243-001	SmartCode Keypad/Touchpad - Thick Door Door Kit, Cylinder and 2 Keys	Silver	Each	\$34.00
84243-002	SmartCode Keypad/Touchpad - Thick Door Door Kit, Cylinder and 2 Keys	Black	Each	\$34.00
84355-001	Powerbolt 3 & Elements by Weiser Electronic Deadbolt - Thick Door Door Kit	N/A	Each	\$10.00

SAFE LOCK SCREW PACKS

PART NUMBER	COMPATIBILITY	FINISH	QUANTITY	LIST PRICE
810000-411	9100 Deadbolts	Satin Nickel	Each	\$10.00
810000-412	9100 Deadbolts	Matte Black	Each	\$10.00
810000-457	1000/3000/5000 Knob/Lever	Satin Nickel	Each	\$10.00
810000-458	1000/3000/5000 Knob/Lever	Matte Black	Each	\$10.00
810000-460	7000 Knob/Lever	Satin Nickel	Each	\$10.00
810000-459	7000 Knob/Lever	Matte Black	Each	\$10.00

THIN/THICK DOOR SCREW PACKS

PART NUMBER	COMPATIBILITY	FINISH	QUANTITY	LIST PRICE
83017-002	GD 1471 Thin Door Screw Pack 1-3/8"	Satin Nickel	Each	\$10.00
83017-001	GD 1471 Thin Door Screw Pack 1-3/8"	Satin Chrome	Each	\$10.00
83017-003	GD 1471 Thin Door Screw Pack 1-3/8"	Matte Black	Each	\$10.00
83022-002	GD 1471 Thick Door Screw Pack	Satin Nickel	Each	\$12.00
83022-001	GD 1471 Thick Door Screw Pack	Satin Chrome	Each	\$12.00
83022-003	GD 1471 Thick Door Screw Pack	Matte Black	Each	\$12.00
81691-006	GCD9471/GD9471 Thick Door Screw Pack	Brass	Each	\$12.00
81691-007	GCD9471/GD9471 Thick Door Screw Pack	Satin Nickel	Each	\$12.00
81691-002	GCD9471/GD9471 Thick Door Screw Pack	Satin Chrome	Each	\$12.00
81691-005	GCD9471/GD9471 Thick Door Screw Pack	Matte Black	Each	\$12.00
820289-002	SSD9471 Thick Door Screw Pack	Satin Nickel	Each	\$12.00
820289-001	SSD9471 Thick Door Screw Pack	Satin Chrome	Each	\$12.00
820289-003	SSD9471 Thick Door Screw Pack	Matte Black	Each	\$12.00
86129-001	GDC9471 Thick Door Screw Pack	Brass	Each	\$12.00
86129-007	GDC9471 Thick Door Screw Pack	Satin Nickel	Each	\$12.00
86129-006	GDC9471 Thick Door Screw Pack	Satin Chrome	Each	\$12.00
86129-008	GDC9471 Thick Door Screw Pack	Matte Black	Each	\$12.00
81838-004	Handleset Adapter Thick Door Pack	Satin Nickel	Each	\$12.00
81838-002	Handleset Adapter Thick Door Pack	Polished Chrome	Each	\$12.00
81838-003	Handleset Adapter Thick Door Pack	Matte Black	Each	\$12.00

Intro
Electronics
Box Pack
Visual Pack
Parts

THIN/THICK DOOR SCREW PACKS

PART NUMBER	COMPATIBILITY	FINISH	QUANTITY	LIST PRICE
88376-004	Thick Door Handleset Screw & Washer for Elements Handlesets	Satin Nickel	Each	\$12.00
88376-005	Thick Door Handleset Screw & Washer for Elements Handlesets	Satin Chrome	Each	\$12.00
88376-003	Thick Door Handleset Screw & Washer for Elements Handlesets	Matte Black	Each	\$12.00
81861-001	Thick Door Handleset Screw & Washer for Contemporary Handlesets	N/A	Each	\$12.00
83724-001	Thick Door Handleset Screw & Washer Augusta/Hawthorne/Tavaris	N/A	Each	\$12.00
83669-001	Handleset Mechanism with Thick Door Spindle	N/A	Each	\$25.00
85202-001	Thick Door Screw Pack for Passage, Privacy, Entry & Interior Pack Chassis Screws for Knob/Levers - Weiser Portfolio	Satin Nickel	Each	\$12.00
85202-002	Thick Door Screw Pack for Passage, Privacy, Entry & Interior Pack Chassis Screws for Knob/Levers - Weiser Portfolio	Matte Black	Each	\$12.00
89933-003	Thick Door Screw Pack for Contemporary Levers - Weiser Portfolio	Satin Nickel	Each	\$12.00
89933-001	Thick Door Screw Pack for Contemporary Levers - Weiser Portfolio	Satin Chrome	Each	\$12.00
89933-002	Thick Door Screw Pack for Contemporary Levers - Weiser Portfolio	Matte Black	Each	\$12.00
83752-001	Passage Thick Door Exterior Chassis Kit - Weiser Portfolio	Satin Chrome	Each	\$25.00
83752-002	Passage Thick Door Exterior Chassis Kit - Weiser Portfolio	Brass	Each	\$25.00
83752-003	Passage Thick Door Exterior Chassis Kit - Weiser Portfolio	Satin Nickel	Each	\$25.00
83752-004	Passage Thick Door Exterior Chassis Kit - Weiser Portfolio	Matte Black	Each	\$25.00
81706-005	Thick Door Screw Pack for Elements Levers & all Knobs	Brass	Each	\$12.00
81706-006	Thick Door Screw Pack for Elements Levers & all Knobs	Satin Nickel	Each	\$12.00
81706-002	Thick Door Screw Pack for Elements Levers & all Knobs	Satin Chrome	Each	\$12.00
81706-007	Thick Door Screw Pack for Elements Levers & all Knobs	Matte Black	Each	\$12.00

Intro

Electronics

Box Pack

Visual Pack

Parts

THICK DOOR CHEAT SHEET

GA8771 HANDLESET THICK DOOR

PRAGUE, PRESCOTT, SAN CLEMENTE, VANCOUVER	PART NUMBER	COMPATIBILITY	FINISH	QUANTITY	LIST PRICE
Step 1. Choose your Deadbolt Screw Pack	83022-002	GD 1471 Thick Door Screw Pack	Satin Nickel	Each	\$12.00
	83022-001	GD 1471 Thick Door Screw Pack	Satin Chrome	Each	\$12.00
	83022-003	GD 1471 Thick Door Screw Pack	Matte Black	Each	\$12.00
Step 2. Order Handleset Mechanism	83669-001	Handleset Mechanism with Thick Door Spindle	N/A	Each	\$25.00
Step 3. Order your Knob/Lever Screw Pack	85202-001	Thick Door Screw Pack for Passage, Privacy, Entry & Interior Pack Chassis Screws for Knob/Levers - Weiser Portfolio	Satin Nickel	Each	\$12.00
	85202-002	Thick Door Screw Pack for Passage, Privacy, Entry & Interior Pack Chassis Screws for Knob/Levers - Weiser Portfolio	Matte Black	Each	\$12.00
	89933-003	Thick Door Screw Pack for Contemporary Levers - Weiser Portfolio	Satin Nickel	Each	\$12.00
	89933-001	Thick Door Screw Pack for Contemporary Levers - Weiser Portfolio	Satin Chrome	Each	\$12.00
	89933-002	Thick Door Screw Pack for Contemporary Levers - Weiser Portfolio	Matte Black	Each	\$12.00
Optional Step 4. Order your Bottom Screw Pack	81861-001	Thick Door Handleset Screw & Washer for Contemporary Handlesets	Satin Nickel	Each	\$12.00

GA9771 HANDLESET THICK DOOR

AUGUSTA, HAWTHORNE, HERITAGE, TAVARIS	PART NUMBER	COMPATIBILITY	FINISH	QUANTITY	LIST PRICE
Step 1. Choose your Deadbolt Screw Pack	81691-006	GCD9471/GD9471 Thick Door Screw Pack	Brass	Each	\$12.00
	81691-007	GCD9471/GD9471 Thick Door Screw Pack	Satin Nickel	Each	\$12.00
	81691-002	GCD9471/GD9471 Thick Door Screw Pack	Satin Chrome	Each	\$12.00
	81691-005	GCD9471/GD9471 Thick Door Screw Pack	Matte Black	Each	\$12.00
Step 2. Order Handleset Mechanism	83669-001	Handleset Mechanism with Thick Door Spindle	N/A	Each	\$25.00
Step 3. Order your Knob/Lever Screw Pack	85202-001	Thick Door Screw Pack for Passage, Privacy, Entry & Interior Pack Chassis Screws for Knob/Levers - Weiser Portfolio	Satin Nickel	Each	\$12.00
	85202-002	Thick Door Screw Pack for Passage, Privacy, Entry & Interior Pack Chassis Screws for Knob/Levers - Weiser Portfolio	Matte Black	Each	\$12.00
	89933-003	Thick Door Screw Pack for Contemporary Levers - Weiser Portfolio	Satin Nickel	Each	\$12.00
	89933-001	Thick Door Screw Pack for Contemporary Levers - Weiser Portfolio	Satin Chrome	Each	\$12.00
	89933-002	Thick Door Screw Pack for Contemporary Levers - Weiser Portfolio	Matte Black	Each	\$12.00
Optional Step 4. Order your Bottom Screw Pack	83724-001	Thick Door Handleset Screw & Washer Augusta/Hawthorne/Tavaris	N/A	Each	\$12.00

Intro
Electronics
Box Pack
Visual Pack
Parts

GAC9771 HANDLESET THICK DOOR

AMADOR, BRENTWOOD, HENLEY, KINGSWAY	PART NUMBER	COMPATIBILITY	FINISH	QUANTITY	LIST PRICE
Step 1. Choose your Deadbolt Screw Pack	86129-001	GDC9471 Thick Door Screw Pack	Brass	Each	\$12.00
	86129-007	GDC9471 Thick Door Screw Pack	Satin Nickel	Each	\$12.00
	86129-006	GDC9471 Thick Door Screw Pack	Satin Chrome	Each	\$12.00
	86129-008	GDC9471 Thick Door Screw Pack	Matte Black	Each	\$12.00
Step 2. Order Handleset Mechanism	83669-001	Handleset Mechanism with Thick Door Spindle	N/A	Each	\$25.00
Step 3. Order your Knob/Lever Screw Pack	81706-005	Thick Door Screw Pack for Elements Levers & all Knobs	Brass	Each	\$12.00
	81706-006	Thick Door Screw Pack for Elements Levers & all Knobs	Satin Nickel	Each	\$12.00
	81706-002	Thick Door Screw Pack for Elements Levers & all Knobs	Satin Chrome	Each	\$12.00
	81706-007	Thick Door Screw Pack for Elements Levers & all Knobs	Matte Black	Each	\$12.00
Optional Step 4. Order your Bottom Screw Pack	88376-004	Thick Door Handleset Screw & Washer for Elements Handlesets	Satin Nickel	Each	\$12.00
	88376-005	Thick Door Handleset Screw & Washer for Elements Handlesets	Satin Chrome	Each	\$12.00
	88376-003	Thick Door Handleset Screw & Washer for Elements Handlesets	Matte Black	Each	\$12.00

MISCELLANEOUS

PART NUMBER	COMPATIBILITY	FINISH	QUANTITY	LIST PRICE
800004-349	Legacy Weiser Handleset Mechanism		Each	\$60.00
820309-001	Handleset Mechanism		Each	\$30.00
820318-001	Deadbolt Frost Insert		Each	\$15.00
820314-001	Knob/Lever Frost Insert		Each	\$17.00
81226-004	Inactive 9771 Deadbolt Cylinder Cover	Satin Chrome	Each	\$8.00
81226-007	Inactive 9771 Deadbolt Cylinder Cover	Satin Nickel	Each	\$8.00
81226-010	Inactive 9771 Deadbolt Cylinder Cover	Matte Black	Each	\$8.00
81226-006	Inactive 9771 Deadbolt Cylinder Cover	Polished Chrome	Each	\$8.00
84272-001	SmartCode Keypad/Touchpad Battery Cover		Each	\$8.00
84353-001	Powerbolt 3 & Elements by Weiser Electronic Deadbolt Battery Cover		Each	\$8.00
84249-001	SmartCode Keypad/Touchpad, Powerbolt 3 & Elements by Weiser Electronic Deadbolt Mounting Plate		Each	\$8.00
800003-547	Weiser Finish Ring		Each	\$27.00

Intro
Electronics
Box Pack
Visual Pack
Parts