

**GENERAL INFORMATION**

	Page
TERMS & CONDITIONS	2
GENERAL INFORMATION	4
HOW TO ORDER	5
SMARTKEY	18
MICROBAN	21

**BOX PACK**

		Page
WEISER	Handlesets	40
	Levers	46
	Knobs	53
	Deadbolts	55
	Pocket Doorlocks	57
	Specifications	59
ELEMENTS	Handlesets	64
	Levers	66
	Knobs	68
	Deadbolts	69
	Specifications	71
SAFELOCK	Levers	74
	Knobs	77
	Deadbolts	78
	Specifications	80

**VISUAL PACK**

		Page
ELECTRONICS	Halo Touch	24
	Halo	24
	Premis	24
	Aura	25
	Obsidian	25
	SmartCode 10 Commercial Lever	25
	SmartCode 10 Residential Lever	25
	Smartcode Traditional Keypad	26
	Smartcode Contemporary Keypad	26

Effective October 1, 2022  
Updated February 2023



Scan here for the latest copy of this document. Available on [weiserlock.com](http://weiserlock.com).

**VISUAL PACK**

		Page
ELECTRONICS	Smartcode Traditional Touchpad	26
	Smartcode Contemporary Touchpad	26
	Powerbolt 2	27
	Powerbolt 1	27
	SmartCode Handlesets	28
	Specifications	29
WEISER	Handlesets	84
	Levers	90
	Knobs	93
	Deadbolts	95
	Combo Packs	97
	Pocket Doorlocks	98
ELEMENTS	Padlocks	98
	Handlesets	100
	Levers	101
	Knobs	103
	Deadbolt	104
	Combo Packs	105
SAFELOCK	Handleset	108
	Levers	109
	Knobs	112
	Deadbolts	113
	Combo Packs	113

**PARTS & ACCESSORIES**

	Page
PARTS & ACCESSORIES	116

## TERMS AND CONDITIONS OF SALE

Terms of payment – Net 30 days following date of invoice. Weiser® reserves the right to charge and recover on invoices which are not paid within the above terms, a service charge of 1-1/2% a month for each month or fraction thereof during which the invoice remains unpaid, said service charge, however, not to exceed the highest applicable legal rate of interest. All orders, whether solicited or written by our sales representatives or forwarded by our customers are deemed to be mere offers to purchase in accordance with these Terms and Conditions of Sale until actually accepted by us at our home office. We reserve the right to refuse any order as well as the right to sell or not sell to any firm at our sole discretion. The acceptance of an order is expressly made conditional upon your assent to these Terms and Conditions of Sale. We object to the inclusion of any different or additional terms or conditions, even if the same are included in your order, a contract of sale will result upon the Terms and Conditions of Sale stated herein only.

### PRICES

All prices are subject to change without notice and are not guaranteed. All taxes, duties or other charges are the responsibility of the customer.

### CLAIMS

Price or shortage claims must be submitted in writing to Spectrum Brands 3001 Deming Way, Middleton WI, 53562 within 30 days from the date of invoice.

### CHANGES OR CANCELLATIONS

The goods purchased hereunder shall be and remain the property of Weiser until the purchase price has been paid in full by the purchaser.

### CHANGES, CANCELLATIONS AND RETURNS

Beyond 2 working days of our acknowledgement date no changes can be made. Additions to an order will be handled as a separate order and must meet applicable minimum order requirements. Order cancellation on regular stock items only, or any portion thereof is allowed only upon prior written consent from Weiser, and the payment of cancellation charges deemed appropriate.

### MINIMUM CHARGE

No order will be invoiced for less than \$100.00 net plus shipping charges except for lock accessory parts.

### MINIMUM ANNUAL SALES VOLUME

The company reserves the right to discontinue direct sales to any customer who does not meet the minimum annual sales volume requirement. The current annual requirement is \$50,000.00. Your annual purchases are determined by accepted, noncancelled, and shipped orders received during each calendar year. Weiser reserves the right to change any or all minimum annual sales volume requirements at any time. Any customer who does not meet the annual sales volume requirements may continue to purchase Weiser products through a Weiser distributor.

### RETURNS

Defective merchandise returned to our distribution centres requires prior written authorization from a Weiser Sales Rep or the Sales Office. A return goods authorization number must accompany the returned shipment. The return authorization must include an itemized listing of the merchandise and an explanation stating the reason for return. There will be a 20% product restocking fee on all returned merchandise.

### FREIGHT

All goods are invoiced FOB to our warehouse. Upon delivery of shipments to the carrier, title to, and the risk of loss or damage in transit for such shipments, passes to our customer.

Weiser's standard policy is to pay freight charges on all orders to a single destination in Canada by carrier and route of our choice. Weiser reserve the right to charge a \$25 handling charge for orders that do not meet the customer's minimum.

### DELIVERY CONDITIONS

Shipping schedules are our best estimates, and cannot be guaranteed. Weiser is not responsible for any direct or consequential loss or damage resulting from an inability or delay in meeting shipping schedules.

### PRODUCT WARRANTY

Warranties cover the original residential user of Weiser Products against defects in material and workmanship as long as the original user occupies the residential premises upon which the Product was originally installed. This warranty DOES NOT COVER abused or misused products or non-commercial products used in commercial applications. Upon return of a defective product to Weiser Corporation, Weiser shall either replace the product or refund the purchase price, at our discretion. If a covered defect occurs, call 1-800-501-9471 in Canada or return it to Weiser, 101-255 Longside Drive, Mississauga, ON L5W 0G1. A finish deterioration occurring from the use of paints, solvents, or other chemicals is not a defect in the finish and is not covered by this warranty. Weiser is not liable for incidental or consequential damages. Some do not allow the exclusion or limitation of incidental or consequential damages, so the above exclusion may not apply to you. This warranty gives you specific legal rights and you may also have other rights that vary from state to state.

### PATENT INDEMNITY

We agree to defend any suit or proceeding brought against our customer so far as based on claim that our products, or any part thereof, made solely to our specifications and furnished to our customer constitute an infringement of any U.S. patent, if notified promptly in writing and given authority, information and assistance at our expense for the defense of same, and we shall pay all damages and costs awarded therein against our customer. In case our products, or any part thereof, is in such suit held to constitute infringement and their use is enjoined, we will, at our expense and discretion, either procure for our customer the right to continue using the products or replace same with non-infringing products, or modify them so they become noninfringing, or remove such products and refund the purchase price (less depreciation, prorated from the purchase date). The foregoing states our entire liability for patent infringement by our products or any part thereof.

**INTELLECTUAL PROPERTY**

No person or entity may sell, distribute, advertise, market or promote Weiser branded products distributed by Weiser, Spectrum Brands Hardware Home Improvement Division, without prior authorization from Weiser. Customers of Weiser who are authorized to sell Weiser branded products are referred to herein as "Customers."

The Weiser brand and all Weiser trademarks, trade names, product depictions, colors, graphics or logos, whether or not registered or otherwise protected (the "Marks"), remain the sole and exclusive property of Weiser and nothing arising out of the relationship between Weiser and any Customer conveys to Customer any ownership rights in the Marks. Customer may use the Marks and then only in the sale or promotion of authentic Weiser products in compliance with the terms of this policy. The Marks must be used exactly in the form provided and in conformity with all Weiser trademark usage policies or guidelines, including, but not limited to, those relating to shape, color match and imprint quality. Any proposed deviation must be approved in writing by Weiser prior to use. The Marks may not be used in or as part of any Customer domain name on the Internet. Prior to any use of the Marks on goods or services, Customer must submit samples for Weiser's approval.

Additionally, no Customer may use product depictions, graphics, logos or text relating to Weiser products that have not been provided by Weiser in connection with the advertising, promotion or sale of Weiser products without Weiser's prior review and written approval of each such use. The Marks may not be used in or as part of any reseller or other third party (i) domain name or URL on the Internet, (ii) trademark or service mark, or (iii) company or trade name. Any action on the part of a Customer that violates the terms of this policy or otherwise impairs the value of or goodwill associated with the Marks or is otherwise not in conformity with Weiser's standards may result in the suspension or termination of the Customer's authorization or any other remedy permitted by law.

Weiser grants to each of its Customers limited, non-transferable, non-sublicenseable licenses of the patents relating to the Weiser products that the Customer is authorized to sell and of the copyrights in any packaging or other written materials included therewith or related thereto. Said patent and copyright licenses are solely to sell such Weiser products covered by such patents and to which such copyrights relate only to end-users and other Customers in compliance with the terms of this document. The sale of such patented Weiser products and the sale or use of such copyrighted materials by a Customer that violate the terms of this document exceed the scope of the licenses herein granted to the Customer and may constitute patent and/or copyright infringement.

**STANDARDS**

Weiser meets or exceeds the testing requirements specified for each product grade or rating.

- American National Standards Institute (ANSI)
- Builders Hardware Manufacturers Association (BHMA)
- Underwriters Laboratories, Inc. (UL)
- Americans with Disabilities Act (ADA)

**MISCELLANEOUS**

Substitution of non-Weiser components/parts, and any alteration or modification of factory parts, and other lock manufacturer's parts may result in door hardware which does not function properly or will fail and will void all warranties. Orders not specified with keying requirements will be shipped Keyed Differently (KD). Orders with keying requirements of K10 or more must have a "Letter of Release" on file with Weiser stating that Weiser Corporation will not be held liable for cost and expense arising from any loss or damage to property utilizing Weiser products where 10 or more locks have been keyed alike. Contact your Sales Office account representative for a copy of the release form. Weiser reserves the right to revise or modify products, product information, or pricing without notice. Product specifications and pricing reflect available information at the time of printing. Weiser is not responsible for typographic or printing errors.

In the interest of personal security and safety, all locksets and latchset functions that may be used on exterior doors, will be shipped from the factory with deadlocking latches only. Orders received for these functions that indicate spring latches will be converted to deadlocking latches.

In the interest of personal security and safety, all locksets and latchset functions that may be used on exterior doors, will be shipped from the factory with deadlocking latches only. Orders received for these functions that indicate spring latches will be converted to deadlocking latches.

## BACKSET

Backset is the distance from center edge of door to center of the 2-1/8" (54mm) diameter hole, 2-3/8" or 2-3/4" in most cases.

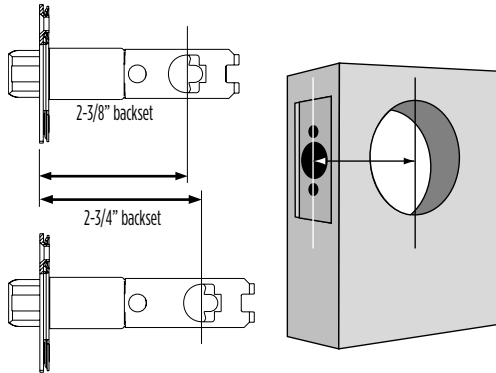

## UNDERWRITERS LABORATORIES LISTED LOCKSETS

To meet Underwriters Laboratories' fire rating requirements UL listed locksets, UL listed latches, and UL listed strikes must be used together.



## AMERICAN WITH DISABILITIES ACT

Please contact Weiser for products that comply with the Americans with Disabilities Act of 1990.



**1 QUANTITY**

INDICATE A NUMBER (unit quantity required)

Example

24

**2 SERIES DESIGNATION**

CHOOSE FROM

Example

	Series	Description	GCD
SAFELOCK	SK	Knobsets	
	SL	Leversets	
	SD	Deadbolts	
	SH	Handlesets	
ELECTRONIC DEADBOLTS ELEMENTS	GED	Electronics	
	GAC	Knobset	
	GAC/GLC	Interior Pack	
	GLC	Leversets	
	GDC	Deadbolts	
	GAC	Handlesets LIP	
	GAC/GLC	Combo Pack	
	WEISER	GA	Knobset
	GA/GLA/SIP	Interior Pack	
	GLA/SPSL/SPVL SENL/SHD	Leversets	
	GD/SSD/SDD/GCD	Deadbolts	
	GA	Handlesets LIP	
	GSC/GSL	Combo Pack	

**NOTE:** All box pack handlesets are ordered LESS INTERIOR PACK (LIP). Interior packs must be ordered separately

**3 FUNCTION NUMBER**

Example

Model	Function	9471
101/1000	Passage/Hall/Closet	
331/3000	Privacy/Bed/Bath	
531/535/5000	Keyed Entry	
581	Storeroom/Vestibule	
12/7000	Inactive Trim, Surface or Bolt through mounting	
1030/1031	Pocket Door Lock	
9771/1100/8771	Single Cylinder Handleset	
71	Inactive Handleset	
9675/9575/96/8675	Interior Pack for Weiser Handlesets	
1471/9471/9100	Single Cylinder Deadbolts	
9371	Double Cylinder Deadbolts	
9571	Key Control Deadbolts	
1460/1490/1450	Powerbolt/SmartCode/SmartCode Lever	
1700/2100 /2200/2300	Smartcode 10/Premis/Obsidian	
1850/2500/ 3000	Aura/Halo/Halo Touch	
026	Padlocks	
7451/7481/6000	Combo Packs	

**NOTE:** All box pack handlesets are ordered LESS INTERIOR PACK (LIP). Interior packs must be ordered separately

Intro

Electronics

Box Pack

Visual Pack

Parts

**HOW TO ORDER**

**4 STYLE**

		CHOOSE FROM				CHOOSE FROM					
		Series	Description			Series	Description				
<b>KNOB &amp; LEVERS</b>	<b>SAFELOCK</b>	AS	Athens	<b>KNOB &amp; LEVERS</b>	<b>WEISER</b>	PGK	Prague (knob)				
		DAL	Dayton			SAL	Singapore				
		GV	Grapevine			SYL	Sydney				
		LY	Layton			TC	Toluca				
		RG	Regina			T	Troy				
		REL	Reminy			WK	Wickham				
		WTL	Westley			<b>HANDLESETS</b>	<b>SAFELOCK</b>	BRN	Branton		
		WI	Winston					DT	Daytona		
		<b>ELEMENTS</b>	AI					Alfini	<b>ELEMENTS</b>	AMD	Amador
			BLM					Belmont		BDH	Brentwood
	B		Beverly	KNH	Kingsway						
	BRNL		Breton	<b>WEISER</b>	ADH			Ashfield			
	CSL		Casey		A			Augusta			
	F		Fairfax		AVH			Avalon			
	HSL		Hollis		HE			Hawthorne			
	KML		Kim		H			Heritage			
	TSL		Tristan		PGH	Prague					
	Y		Yukon		PTH	Prescott					
	<b>WEISER</b>	ADL	Ashfield		SCE	San Clemente					
		A	Aspen		TVH	Tavaris					
AVL		Avalon	VNH		Vancouver						
CBK		Cambie									
D		Dane									
G		Galiano									
HFL		Halifax									
H		Hancock									
HT		Huntington									
KAL		Katella									

**5 FINISH**

Finish	Description	ANSI / BHMA
3	Polished Brass	605
3BR	Lifetime Polished Brass	605E
4	Satin Brass	-
5	Antique Brass	609
11P	Venetian Bronze	-
15	Satin Nickel	619
15A	Antique Nickel	620
26	Polished Chrome	625
26D	Satin Chrome	626
514	Matte Black	-
9/32D	Bright Bronze/ Satin Chrome	-

**6 KEYING**

CHOOSE FROM

Example

Code	Description	SMT
KD	Keyed Differently	
K2, K3	Keyed Alike (2 Locksets, 3 Locksets)	
MK	Master Keyed	
CK	Builder (Construction) Keyed	
GMK	Grand Master Keyed	
CMK	Builder (Construction) Master Keyed	
MAIS	Maison Keying	
PK	Project Keying	
SMT	SmartKey	
WS	Weiser Pin & Tumbler	
KW	KW Pin & Tumbler	

**NOTE:** SMT is the default configuration.

**7 PACKAGING**

CHOOSE FROM

Example

<b>B</b>		
<b>B</b> Box Pack	<b>MS</b> Merchandiser Sensormatic	<b>VS</b> Visual Pack

**8 HANDING (LEVERS)**

CHOOSE FROM

Example

<b>LH</b> Left Hand	<b>RH</b> Right Hand
---------------------	----------------------

To determine the handing of a door face the OUTSIDE of the door. If the hinge is on the left side of the door, the door is left handed (LH). If the hinge is on the right side of the door, the door is right handed (RH).

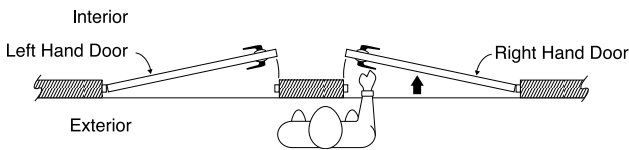

**NOTE:** Handing required for Inactive levers and handlesets with handed levers

**9 MISCELLANEOUS**

IF REQUIRED:

Code	Description
ULC	ULC 3 Hour Rated Fire Door
FD	20 Minute Rated Fire Door (FD)

**10 LATCH CONFIGURATION**

CHOOSE FROM

Example

Latch	Description	SL
SL/SCAL	Square Corner Adjustable Latch	
RL/RCAL	Radius Corner Adjustable Latch	
DI/RFAL	Round Face Drive-in Latch	
4L	4-Way Adjustable Latch	
6L	6-Way Adjustable Latch	

**11 STRIKE CONFIGURATION**

CHOOSE FROM

Example

Code	Description	S2
R1	Radius Cornered Strike (Interior/Exterior)	
R2	Radius Cornered Strike (Deadbolts)	
R3	1/4" (6.4mm) Radius Full Lip Deadbolt Strike	
S1	Square Cornered Strike (Interior/Exterior)	
S2	Square Cornered Strike (Deadbolts)	
S3	Square Corner Full Lip Deadbolt Strike	
S5	Square Cornered Strike (For Metal Frames)	
T1	T-Strike (4-7/8" Length, ASA Strike)	
T2	T-Strike (2-3/4", ANSI Strike), Exterior	
T3	Square Corner T-Strike for Deadbolt	
DS	Square and Radius Cornered Strike (Interior pack Only)	

**NOTE:** For products utilizing an upper and lower strike (such as handlesets, entrysets, or security sets) show the upper strike designation, then lower strike designation. For example: S1S2

**ORDERING TEMPLATE**

**HANDLESETS**

1. Required – Start your order configuration with the following required information:

**EXAMPLE:**

DESIGNATION	QUANTITY	SERIES	FUNCTION	KEYWAY
WS-HS	12	GA WEISER	9771 SING CYL WEISER	SMT SMARTKEY
		GA WEISER	71 INACTIVE WEISER	WS WEISER P&T
		GAC ELEMENTS	8771 SING CYL WEISER	KW KWIKSET P&T
			61 INACTIVE WEISER	
			7771 HANDLESET MINUS	
			9771 SING CYL WEISER	

**INTERIOR TRIMS**

1. Required – Start your order configuration with the following required information:

**EXAMPLE:**

DESIGNATION	QUANTITY	SERIES	FUNCTION	HANDING
WS-HS	12	GA/GLA/SIP WEISER	9675 SING CYL WEISER	LH LEFT HAND
		GA/GLA WEISER	96 INACTIVE WEISER	RH RIGHT HAND
		GAC/GLC ELEMENTS	8675 SING CYL WEISER	000 Non -handed
			86 INACTIVE WEISER	
			9675 SING CYL WEISER	

*Series, style, function and latch options are specific to colour coding when noted.*



## HANDLESETS

TVH		514		CMK					
STYLE	FINISH	FORMAT	KEYED ALIKE	KEYED LINES	KEYS				
ADH	ASHFIELD	3BR	LIFETIME BRASS	KD	KEYED DIFFERENT	KA	KEYED ALIKE	WITH	3KEY
A	AUGUSTA	5	ANTIQU BRASS	KA	KEYED ALIKE	KD	KEYED DIFFERENT		4KEY
AVH	AVALON	11P	VENETIAN BRONZE	MK	MASTER KEYED				5KEY
HE	HAWTHORNE	15	SATIN NICKEL	CK	CONSTRUCTION KEYED				6KEY
TVH	TAVARIS	15A	ANTIQU NICKEL	CMK	CONSTRUCTION MASTER KEYED				XKEY
PGH	PRAGUE	26	POLISHED CHROME						NO KEY
SCE	SAN CLEMENTE	26D	SATIN CHROME						
VNH	VANCOUVER	514	MATTE BLACK						
SCE/HFL	SAN CLEMENTE								
AMD	AMADOR								
BDH	BRENTWOOD								
KNH	KINGSWAY								

## INTERIOR TRIMS

HFL		514		SQT		FD-SL		R1R2	
STYLE	FINISH	TRIM	LATCH	STRIKE (bottom/top)					
ADL	ASHFIELD	3BR	LIFETIME BRASS	RDT	ROUND	6L	6WAY ADJ	R1R2	RADIUS/RADIUS
A	ASPEN	5	ANTIQU BRASS	SQT	SQUARE	DI	DRIVE IN	R1S2	RADIUS/SQUARE
AVL	AVALON	11P	VENETIAN BRONZE			FD-DI	20 MIN - DRIVE IN	S1R2	SQUARE/RADIUS
BRNL	BRETON	15	SATIN NICKEL			FD-RL	20 MIN - RADIUS	S1S2	SQUARE/SQUARE
G	GALIANO	15A	ANTIQU NICKEL			FD-SL	20 MIN - SQUARE	XS	NO STRIKE
HFL	HALIFAX	26	POLISHED CHROME			RL	RADIUS CORNER		
KML	KIM	26D	SATIN CHROME			SL	SQUARE CORNER		
LSL	LISBON	514	MATTE BLACK			XL	NO LATCH		
MIL	MILAN								
MRL	MONTREAL								
SAL	SINGAPORE								
SYL	SYDNEY								
TC	TOLUCA								
CBK	CAMBIE								
F	FAIRFAX								
H	HANCOCK								
HT	HUNTINGTON								
P	PHOENIX								
T	TROY								
HFL	HALIFAX								
LSL	LISBON								
MRL	MONTREAL								
SAL	SINGAPORE								
CBK	CAMBIE								
AI	ALFINI								
BLM	BELMONT								
BRNL	BRETON								
HSL	HOLLIS								
KML	KIM								
TSL	TRISTAN								
B	BEVERLY								
F	FAIRFAX								
Y	YUKON								

Series, style, function and latch options are specific to colour coding when noted.

**ORDERING TEMPLATE**

**DEADBOLTS**

1. Required – Start your order configuration with the following required information:

**EXAMPLE:** WS-DB 12 SSD 9471 000 WS 26 SQT

DESIGNATION	QUANTITY	SERIES	FUNCTION	UL RATING	KEYWAY	FINISH	TRIM
WS-DB	12	GCD WEISER	9471 SING CYL	000 NONE	SMT SMARTKEY	3BR LIFETIME BRASS	RDT ROUND
SL-DB		GD WEISER	9371 DB CYL	ULC 3HR FIRE	WS WEISER P&T	5 ANTIQUE BRASS	SQT SQUARE
		SSD WEISER	9571 KEY CNT		KW KWIKSET P&T	11P VENETIAN BRONZE	000 TRADITIONAL RDT
		GDC ELEMENTS	9471 SING CYL			15 SATIN NICKEL	
		SD SAFELOCK	9371 DB CYL			15A ANTIQUE NICKEL	
			1471 SING CYL			26 POLISHED CHROME	
			9471 SING CYL			26D SATIN CHROME	
			9471 SING CYL			514 MATTE BLACK	
			9100 SING CYL				
			9102 SING CYL UL				

**LEVERS**

1. Required – Start your order configuration with the following required information:

**EXAMPLE:** WS-LV 12 GLA 101 000 000 HFL 15

DESIGNATION	QUANTITY	SERIES	FUNCTION	HANDING	UL RATING	KEYWAY	STYLE	FINISH
WS-LV	12	GLA	101 PASSAGE	LH LEFT HAND	000 NONE	SMT SMARTKEY	ADL ASHFIELD	3BR LIFETIME BRASS
SL-LV		GLC	331 PRIVACY	RH RIGHT HAND	ULC 3HR	WS WEISER P&T	AVL AVALON	5 ANTIQUE BRASS
		SL	535 KEYED	000 Non-handed		KW KWIKSET P&T	SAL SINGAPORE	11P VENETIAN BRONZE
			12 INACTIVE				A ASPEN	15 SATIN NICKEL
			101 PASSAGE				D DANE	15A ANTIQUE NICKEL
			331 PRIVACY				G GALIANO	26 POLISHED CHROME
			535 KEYED				HFL HALIFAX	26D SATIN CHROME
			12 INACTIVE				LSL LISBON	514 MATTE BLACK
			1000 PASSAGE				MIL MILAN	
			1002 PASSAGE UL				MRL MONTREAL	
			3000 PRIVACY				SYL SYDNEY	
			5000 KEYED				TC TOLUCA	
			5002 KEYED UL				BRNL BRETON	
			7000 INACTIVE				AI ALFINI	
			101-1 THICK DOOR				KML KIM	
							HSL HOLLIS	
							TSL TRISTAN	
							BLM BELMONT	
							DAL DAYLON	
							GV GRAPEVINE	
						WI WINSTON		
						LY LAYTON		
						WTL WESTLEY		

Series, style, function and latch options are specific to colour coding when noted.

## DEADBOLTS

6L

R2

LATCH		STRIKE		FORMAT		KEYED ALIKE		KEYED LINES	KEYS
6L	6WAY ADJ	R2	RADIUS CORNER STRIKE	MK	MASTER KEYED	KA	KEYED ALIKE	WITH	3KEY
DI	DRIVE IN	S2	SQUARE CORNER STRIKE	CK	CONSTRUCTION KEYED	KD	KEYED DIFFERENT		4KEY
FD-DI	20 MIN - DRIVE IN	T3	T STRIKE	CMK	CONSTRUCTION MASTER KEYED				5KEY
FD-RL	20 MIN - RADIUS	R3	1/4" RADIUS FULL LIP	PK	PROJECT KEYING				6KEY
FD-SL	20 MIN - SQUARE	S3	SQUARE CORNER FULL LIP	GMK	GRAND MASTER KEYING				XKEY
RL	RADIUS CORNER	S5	SQUARE CORNER STRIKE: 2-Hole Metal Frame Deadbolt Strike						NO KEY
SL	SQUARE CORNER	XS	NO STRIKE						
XL	NO LATCH	RCS	RADIUS CORNER STRIKE						
RCAL	RADIUS CORNER	S5303	SQUARE CORNER STRIKE: 2-Hole Metal Frame Deadbolt Strike						
RCALFD	20 MIN - RADIUS	SCS	SQUARE CORNER STRIKE						
RFAL	DRIVE IN								
RFALFD	20 MIN - DRIVE IN								
SCAL	SQUARE CORNER								
SCALFD	20 MIN - SQUARE								

## LEVERS

RDT

FD-SL

R1

TRIM		LATCH		STRIKE		FORMAT		KEYED ALIKE		KEYED LINES	KEYS
RDT	ROUND	6L	6WAY ADJ	R1	RADIUS CORNER STRIKE	MK	MASTER KEYED	KA	KEYED ALIKE	WITH	3KEY
SQT	SQUARE	DI	DRIVE IN	S1	SQUARE CORNER STRIKE	CK	CONSTRUCTION KEYED	KD	KEYED DIFFERENT		4KEY
		FD-DI	20 MIN - DRIVE IN	T2	ANSI T STRIKE (2 3/4")	CMK	CONSTRUCTION MASTER KEYED				5KEY
		FD-RL	20 MIN - RADIUS	T6	ANSI T STRIKE (4 7/8")	PK	PROJECT KEYING				6KEY
		FD-SL	20 MIN - SQUARE	XS	NO STRIKE						XKEY
		RL	RADIUS CORNER	RCS	RADIUS CORNER STRIKE						NO KEY
		SL	SQUARE CORNER	NOS	NO STRIKE						
		XL	NO LATCH	SCS	SQUARE CORNER STRIKE						
		RCAL	RADIUS CORNER								
		RCALFD	20 MIN - RADIUS								
		RFAL	DRIVE IN								
		RFALFD	20 MIN - DRIVE IN								
		SCAL	SQUARE CORNER								
		SCALFD	20 MIN - SQUARE								

Series, style, function and latch options are specific to colour coding when noted.

**ORDERING TEMPLATE**

**KNOBS**

1. Required – Start your order configuration with the following required information:

**EXAMPLE:**

WS-KN      12      GA      531      0      SMT      CBK      514

DESIGNATION	QUANTITY	SERIES	FUNCTION	UL RATING		Keyed Function		STYLE	FINISH			
				ULC	3HR	SMT	SMARTKEY					
WS-KN	12	GA	101	PASSAGE	000	NONE	SMT	SMARTKEY	CBK	CAMBIE	3	POLISHED BRASS
SL-KN		GAC	331	PRIVACY	ULC	3HR	WS	WEISER P&T	H	HANCOCK	3BR	LIFETIME BRASS
		SK	531	KEYED			KW	KWIKSET P&T	HT	HUNTINGTON	5	ANTIQUE BRASS
				581	STOREROOM				P	PHOENIX	11P	VENETIAN BRONZE
				12	INACTIVE				T	TROY	15	SATIN NICKEL
				101	PASSAGE				F	FAIRFAX	15A	ANTIQUE NICKEL
				331	PRIVACY				Y	YUKON	26	POLISHED CHROME
				531	KEYED				B	BEVERLY	26D	SATIN CHROME
				581	STOREROOM				RG	REGINA	514	MATTE BLACK
				12	INACTIVE						9/26D	BRONZE/SATIN CHROME
				1000	PASSAGE							
				1002	PASSAGE UL							
				3000	PRIVACY							
				5000	KEYED							
				5002	KEYED UL							
				7000	INACTIVE							

Intro

Electronics

Box Pack

Visual Pack

Parts

Series, style, function and latch options are specific to colour coding when noted.

**KNOBS**

RDT

6L

R1

TRIM		LATCH		STRIKE		FORMAT		KEYED ALIKE		KEYED LINES	KEYS
RDT	ROUND	6L	6WAY ADJ	R1	RADIUS CORNER STRIKE	MK	MASTER KEYED	KA	KEYED ALIKE	WITH	3KEY
SQT	SQUARE	DI	DRIVE IN	S1	SQUARE CORNER STRIKE	CK	CONSTRUCTION KEYED	KD	KEYED DIFFERENT		4KEY
		FD-DI	20 MIN - DRIVE IN	T2	ANSI T STRIKE (2 3/4")	CMK	CONSTRUCTION MASTER KEYED				5KEY
		FD-RL	20 MIN - RADIUS	T6	ANSI T STRIKE (4 7/8")	PK	PROJECT KEYING				6KEY
		FD-SL	20 MIN - SQUARE	XS	NO STRIKE						XKEY
		RL	RADIUS CORNER	RCS	RADIUS CORNER STRIKE						NO KEY
		SL	SQUARE CORNER	NOS	NO STRIKE						
		XL	NO LATCH	SCS	SQUARE CORNER STRIKE						
		RCAL	RADIUS CORNER								
		RCALFD	20 MIN - RADIUS								
		RFAL	DRIVE IN								
		RFALFD	20 MIN - DRIVE IN								
		SCAL	SQUARE CORNER								
		SCALFD	20 MIN - SQUARE								

Intro

Electronics

Box Pack

Visual Pack

Parts

Series, style, function and latch options are specific to colour coding when noted.

**ORDERING TEMPLATE**

**CYLINDER OPTIONS**

PRODUCT CODE	DESCRIPTION	HANDLESETS	DEADBOLTS	KNOBS & LEVERS
SMT	5 pin SmartKey Re-Keying Technology with KWI Keyway Default	✓	✓	✓
WS	Weiser 5-pin Pin & Tumbler	Limited	Limited	Limited
KW	Kwikset 5-pin Pin & Tumbler	Limited	Limited	Limited

**KEYING OPTIONS**

KEYING	DESCRIPTION	SMT	WS	KW	ADDITIONAL CHARGE	NOTES	ORDERING EXAMPLE - CONFIRMATION NOMENCLATURE
KD	Keyed Different - Each lock is individually keyed to a different key cut	✓	✓	✓	No Charge	1 set of 2 keys cut the same (additional keys can be ordered through service parts program)	QTY 11 - SSD9471 15 SMT SQT B 6LR2
KA	Keyed Alike - All locks are keyed to same key cut number	✓	✓	✓	No Charge	Only available with a given cylinder type, SMT keyway cannot be keyed alike to WS keyway. Included: 1 set of 2 keys cut to same number for entire series	QTY 11 - SSD9471 15 WS KA11 SQT B 6LR2
WITH	With - All locks across multiple lines are keyed to same key cut	✓	✓	✓	No Charge	Only available with a given cylinder type, SMT keyway cannot be keyed alike to WS keyway. Included: 1 set of 2 keys cut to same number for entire series	QTY 25 - SSD9471 15 WS SQT B SLS2 WITH QTY 25 - SSD9471 15 WS SQT B FD SLS2 KAZ
KEY CODE	Customer selects the specific key cut that they would like the cylinder to be keyed to	✓	✓	✓	No Charge	Customer must specify the 5 digit code they would like the cylinders to be keyed to	QTY 15 - SSD9471 15 SMT SQT B 6LR2 NOTES: KEYED ALIKE TO : 45325
CK	Construction Keyed - Allows new homes to be keyed to a builder's key during construction. After homeowner uses their key, the builder key is rendered inoperable	✗	✓	✓	\$5.25	Only available with WS and KW keyways. Included: 5 Construction Keys and 1 set of 2 keys cut to same number for each lock	QTY 12 - GD1471 15 CK WS RDT B FD SLS5
MK	Master Keyed - Allows multiple keys to operate a single lock. Often used in multi-family applications for owners and tenants.	✗	✓	✓	\$3.50	Only available with WS and KW keyways. Included: 5 Master Keys and 1 set of 2 keys cut to the same number for each lock	QTY 4 - SSD9471 15 K4 MK WS SQT B SLR2
CMK	Construction Master Keyed - Allows multiple keys to operate a single lock, with the added functionality of a Construction Key. Often used in multi-family applications.	✗	✓	✓	\$8.75	Only available with WS and KW keyways. Included: 5 Master Keys, 5 Construction Keys and 1 set of 2 keys cut to same number for each lock	QTY 4 - SSD9471 15 K4 CMK WS SQT B SLR2
GMK	Master key designed to fit a number of different master keyed systems	✗	✓	✓	\$7.00	Only available with WS and KW keyways. Included: 5 Grand Master keys, 5 Master Keys and 1 set of 2 keys cut to same number for each lock	QTY 4 - SSD9471 15 K4 GMK WS SQT B SLR2
XKEY	Orders will ship with no keys in product boxes. Often used in multi-family applications.	✓	✓	✓	No Charge	Keys will arrive in envelopes prior to product shipment.	QTY 4 - SSD9471 15 K4 XKEY WS SQT B SLR2
TC/BC GCD9571 SMT	Key Control Deadbolt application: Top Cylinder (TC) = Master Cylinder Bottom Cylinder (BC) = Tenant Cylinder	✓	✗	✗	No Charge	Only available with SMT keyways. Included: default 2-TC keys and 2 BC-keys. For KA options, see multi-family order example guide.	QTY 2 - GCD9571 15 KD SMT SQT B SLS2
STAMPING	Keys are stamped to requested key code or key designation such as MK, CK,2AA or DNC (Do Not Copy)	✗	✓	✓	No Charge	Only available with WS and KW keyways.	QTY 4 - SSD9471 15 K4 CMK WS SQT B SLR2 STAMPING NOTES PER REQUIREMENTS

Intro

Electronics

Box Pack

Visual Pack

Parts

**LATCH OPTIONS**

PRODUCT CODE	DESCRIPTION	UPCHARGE	DEADBOLTS	KNOBS & LEVERS
6L	Latch with kit including collar, back plate, and round and square fronts	Included		
SL/*SCAL	Adjustable latch with Square-Corner Front	Included		
RL/*RCAL	Adjustable latch with Radius-Corner Front	Included		
DL/*RFAL	Adjustable latch with Drive-in Collar or Round Face	Included		

**STRIKE OPTIONS**

PRODUCT CODE	DESCRIPTION	UPCHARGE	DEADBOLTS	KNOBS & LEVERS
S1 / S2 / *SCS	Square Corner strike: S1 = knob/lever, S2 = deadbolt, SCS = Safelock	Included		
R1 / R2 / *RCS	Radius Corner Strike = R1 = knob/lever, R2 = deadbolt, RCS = Safelock	Included		
T3 / T2	T Strike (Metal Door Frame Application)	**		
T6	ANSI ASA-1 Strike (Metal Door Frame Application)	**	N/A	
SS / *SS303	Two Hole Metal Door Deadbolt Strike	**		N/A

\* Denotes Safelock descriptions  
 \*\* Refer to Price Book For Fire Rating and ASA Strike Upcharges

**KEY TABLE**

		MT0	MTS	
WS	TENANT	800000-125	800000-125	
	MK	800004-342	N/A	
	CK	800004-340	N/A	
KW	TENANT	800004-353	800004-355	
	MK	800004-355	N/A	
	CK	800004-353	N/A	
SMT	TENANT	800004-353	800004-355	
	KEY CONTROL	TC	820204-001	820231-001
		BC	800004-353	800004-355

**KEYING ORDER SAMPLE EXAMPLES:**

<b>SMT KA - 1 LINE EXAMPLE</b>	
<b>96 - WS-DB SSD9471 SMT 15 RDT FD-DI R2 KA96 XKEY</b>	
Order Notes:	10 - KA Keys (800004-353 K20 TO DEADBOLT LINE) 5 - RK Keys (800004-353 K10 RANDOM) 192 - TK Keys (800004-353 K4 RANDOM)
Sample Notes:	New project Smartkey, deadbolts are keyed alike to KA key - Used as construction key on site Requesting 20 Keyed Alike Keys - 20 keys that are cut the same and currently operate the locks Requesting 10 Realtor Keys - 10 keys that are cut the same but use a random bitting Requesting 384 Tenant Keys - 96 sets of K4 random bitting sets Requesting all deadbolts ship XKEY - Keys shipped in envelopes and not in individual boxes

\* Two keys per ring, total quantity must be an even amount. Ordering instructions are 1/2 total amount.

<b>SMT KA - 2 LINE EXAMPLE</b>	
<b>48 - WS-DB SSD9471 SMT 15 RDT FD-DI R2 KA48 XKEY</b>	
<b>24 - WS-DB SSD9471 SMT 15 RDT DI R2 KA24 XKEY</b>	
Order Notes:	LINE 1 - KEY ALL ALIKE LINE 2 - KEY ALL ALIKE TO LINE 1 5 - KA Keys (800004-353 K10 TO DEADBOLT LINE) 96 - TK Keys (800004-353 K4 RANDOM)
Sample Notes:	New project Smartkey, deadbolts are keyed alike to KA key - Used as construction key on site Requesting 10 Keyed Alike Keys - 10 keys that are cut the same and currently operate the locks Requesting 192 Tenant Keys - 48 sets of K4 random bitting sets Requesting all deadbolts ship XKEY - Keys shipped in envelopes and not in individual boxes

\* Two keys per ring, total quantity must be an even amount. Ordering instructions are 1/2 total amount.

<b>KEY CONTROL - 1 LINE EXAMPLE</b>	
<b>170 - WS-DB GCD9571 SMT 26 FD-SL S2 KA170 XKEY</b>	
Order Notes:	3 - TC Keys (820204-001 K6 TO TOP CYLINDER) 13 - BC Keys (800004-353 K26 TO BOTTOM CYLINDER) 5 - RK Keys (800004-353 K10 RANDOM) 340 - TK Keys (800004-353 K4 RANDOM)
Sample Notes:	New Key Control project- top cylinders are KA as the master key, bottom cylinders are KA which are used as construction keys on site Requesting 6 Top Cylinder Keys - 6 keys that are cut the same and currently operate the top cylinder of the locks Requesting 26 Bottom Cylinder Keys - 26 keys that are cut the same and currently operate the bottom cylinder of the locks Requesting 10 Realtor Keys - 10 keys that are cut the same but use a random bitting Requesting 680 Tenant Keys - 170 sets of K4 random bitting sets Requesting all deadbolts ship XKEY - Keys shipped in envelopes and not in individual boxes

\* Two keys per ring, total quantity must be an even amount. Ordering instructions are 1/2 total amount.

Intro

Electronics

Box Pack

Visual Pack

Parts



**KEYING ORDER SAMPLE EXAMPLES:**

<b>KEY CONTROL - 2 LINE EXAMPLE</b>	
<b>80 - WS-DB GCD9571 SMT 26 FD-SL S2 KA80 XKEY</b>	
<b>80 - WS-DB SSD9471 SMT 26 RDT SL S2 KA80 XKEY</b>	
Order Notes:	LINE 1 - KEY ALL TOP CYLINDERS ALIKE TO ANY - KEY ALL BOTTOM CYLINDERS ALIKE TO ANY LINE 2 - KEY ALL ALIKE TO BOTTOM CYLINDER ON LINE 1 5 - TC Keys (820204-001 K10 TO TOP CYLINDER) 13 - BC Keys (800004-353 K26 TO BOTTOM CYLINDER) 160 - TK Keys (800004-353 K4 RANDOM)
Sample Notes:	New Key Control project- top cylinders are KA as the master key, bottom cylinders & SSD9471 cylinders are KA which are used as construction keys on site Requesting 10 Top Cylinder Keys - 10 keys that are cut the same and currently operate the top cylinder of the locks Requesting 26 Bottom Cylinder Keys - 26 keys that are cut the same and currently operate the bottom cylinder of the locks Requesting 320 Tenant Keys - 80 sets of K4 random biting sets Requesting all deadbolts ship XKEY - Keys shipped in envelopes and not in individual boxes

*\* Two keys per ring, total quantity must be an even amount. Ordering instructions are 1/2 total amount.*

<b>WS CMK - EXAMPLE</b>	
<b>60 - WS-DB SSD9471 WS 15 SQT FD-SL S2 CMK WITH</b>	
<b>60 - WS-DB SSD9471 WS 15 SQT 6L S2 K2</b>	
Order Notes:	5 - MK Keys (800004-342 K5) MK TO ANY 10 - CK Keys (800004-340 K10) CK TO ANY CMK LINE 1 ONLY
Sample Notes:	Construction Master Keyed project 60 units project - 2 deadbolts KA per unit (Suite entry door is CMK FD & deck door is KA to suite entry) Requesting 5 Master Keys Requesting 10 Construction Keys Requesting 60 sets of Tenant Keys, 4 keys per ring

*\*CK keys are ordered in singles, order amount required, default is 5.*

*\*MK keys have a default of 5 keys, however can be ordered in singles*

*\*Tenant keys do not need to be requested, default is two per lock*

*\*Keys arrive in individual boxes when ordered as (WS) / Keys arrive in envelopes when ordered as (XKEY)*

<b>WS MK - 1 LINE EXAMPLE</b>	
<b>80 - WS-DB SSD9471 WS 15 SQT FD-DI S2 MK KD</b>	
Order Notes:	5 - MK Keys (800004-342 K5) MK TO ANY
Sample Notes:	Master Keyed, Keyed Different 80 units project - 1 deadbolt per unit Requesting 5 Master Keys

*\*MK keys have a default of 5 keys, however can be ordered in singles*

*\*Tenant keys do not need to be requested, default is two per lock*

*\*Keys arrive in individual boxes when ordered as (WS) / Keys arrive in envelopes when ordered as (XKEY)*

<b>KW CK HANDLESET WITH FIRE RATING</b>	
<b>10 - WS-HS GA9771 KW TVH 15 CK</b>	
<b>10 - WS-HS GLA9675 HFL 15 RDT B FD-SL S1S2</b>	
Order Notes:	5 - CK Keys (800004-353 K5) CK TO ANY
Sample Notes:	Construction Keyed Order - Fire Rated Handleset Requesting 5 Construction Keys

*\*CK keys are ordered in singles, order amount required, default is 5.*

*\*Tenant keys do not need to be requested, default is two per lock*

*\*Keys arrive in individual boxes when ordered as (WS) / Keys arrive in envelopes when ordered as (XKEY)*



# SMARTKEY SECURITY™

## THE ONLY LOCK YOU CAN RE-KEY IN SECONDS!

### What is SmartKey?

SmartKey™ is a technology that allows you to re-key a lock in just seconds while improving security without removing the lock from the door.

### How Does it Work?

SmartKey™ has a patented side locking bar technology that replaces the traditional pin and tumbler design. This new design includes BumpGuard™ for improved security against lock-bumping, an attack technique that can defeat traditional pin and tumbler locks.

## SUPERIOR SECURITY

It's why we buy locks in the first place. With SmartKey™ technology from Weiser you are guaranteed to have one of the most secure residential deadbolts on the market.

### ANSI Graded Deadbolts

Deadbolt locks are rated by an independent agency (ANSI) on a grade scale; with Grade 3 being good, and Grade 1 being the best.

### How does SmartKey rate?

All of our SmartKey deadbolts are ANSI rated and approved. In our Collections family of products, many of our SmartKey deadbolts are rated as Grade 1 - providing you with the very best residential security on the market and featuring the highest level of pick resistance available.

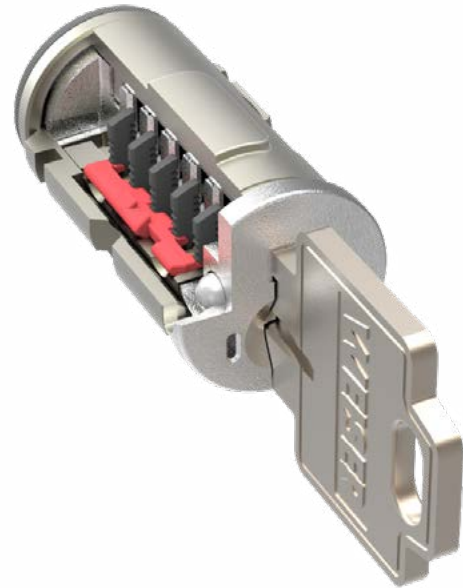

### Available in All Weiser Keyed Functions

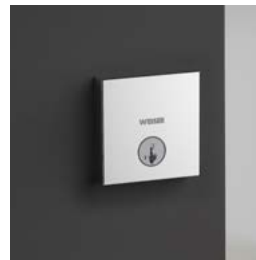

Deadbolts



Handlesets



Levers



Knobs



**BEFORE YOU START...**

These steps show you how to change from the current key that operates the lock to a new key you want to operate the lock. For new purchases, the current key is the one that was supplied with the lockset.

Be sure to install the product on the door first, prior to rekeying.

These instructions illustrate a deadbolt for demonstration purposes, but these SmartKey rekeying instructions also apply to keyed knobs, levers, and handlesets.

**DEFINITIONS**

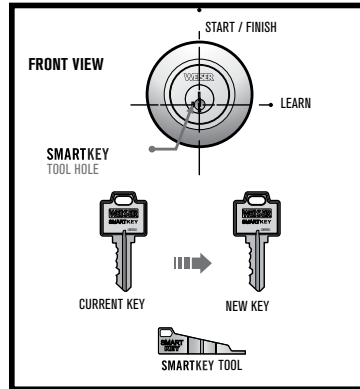

[www.weiserlock.com/smartkey](http://www.weiserlock.com/smartkey)

**STEP 1** TURN TO LEARN POSITION

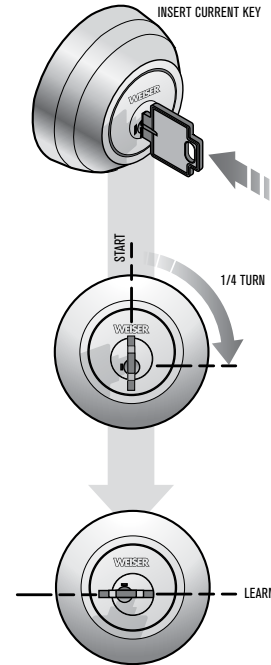

**STEP 2** INSERT AND REMOVE SMART KEY TOOL

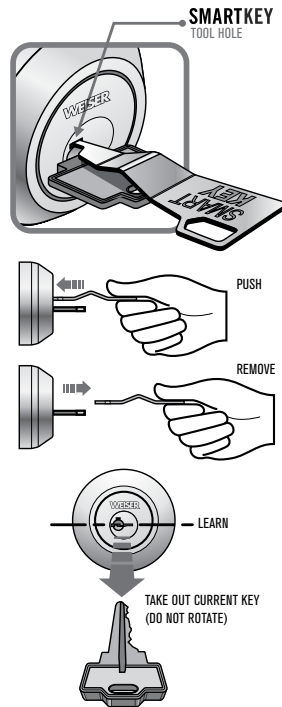

**STEP 3** LEARN NEW KEY

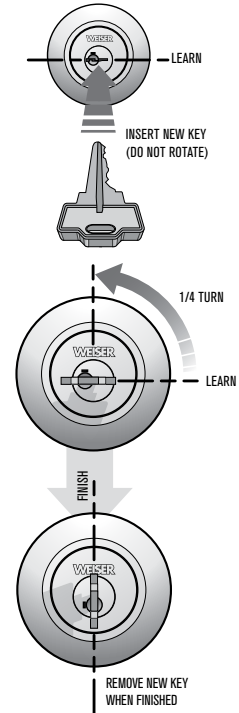



1



HALF TURN

**A** Before you begin, rotate lower dial to the right till it stops to align arrow on upper grip with start point **1** on inner dial.



**B** Insert cylinder all the way into the inner dial.



HALF TURN

**C** Rotate lower dial half turn to the left till it stops, where the two arrows meet.

2

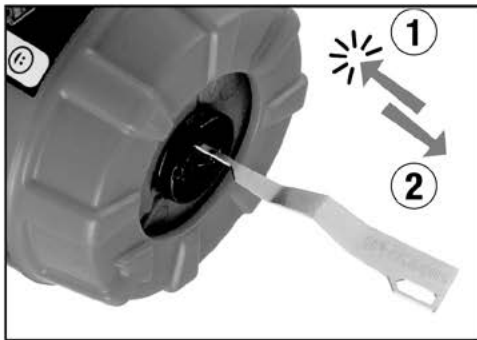

**A** Insert the SmartKey tool into the small hole (next to the keyway) on the cylinder face, and push with force till it goes all the way in, then remove the SmartKey tool.



**B** Insert the key you want to learn in the plug, while being sure not to rotate the plug

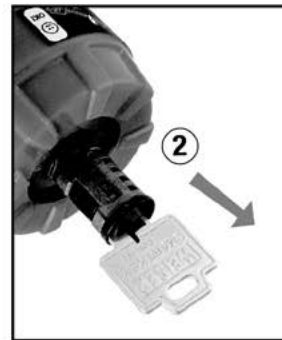

**C** Remove the plug from the reset cradle by gently pulling on the key.

3

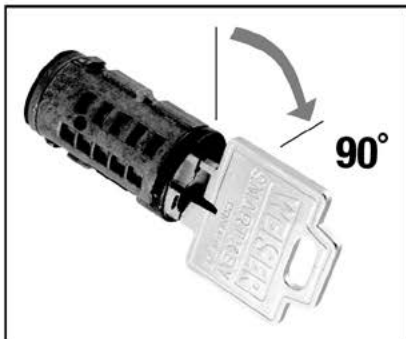

**A** While holding the cylinder body stationary, rotate the key back to the home position.

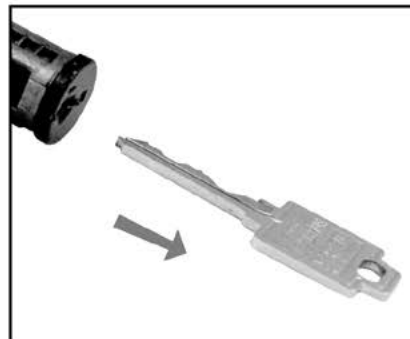

**B** Remove the key.



**C** Reinstall cylinder in product

## Slow the Growth of Bacteria

Weiser® and Microban®, the global leader in built-in antimicrobial protection, have teamed up to improve the standard for door hardware. Weiser® offers antimicrobial protection on select products, inhibiting the growth of bacteria on frequently touched door hardware in the home.

## Benefits of Door Hardware with Microban® Technology

Bacteria can double every 20 minutes on unprotected surfaces, but door hardware with Microban protection works to continuously fight off microbes.

- Door hardware is 99.9% cleaner than knobs without Microban
- The antimicrobial coating last for the lifetime of the hardware finish, so you can worry less and feel more secure in your home.
- 24/7 Antimicrobial protection
- Microban protection is effective against a broad spectrum of bacteria

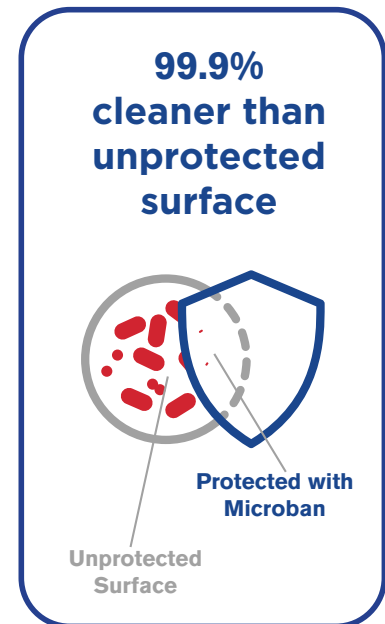

## Microban finish is available on select products.

Look for the Microban sticker:







# ELECTRONICS



Intro

Electronics

Box Pack

Visual Pack

Parts

HALO TOUCH		Finish Availability	GED 3000
15	Satin Nickel		9GED30000-001
514	Matte Black		9GED30000-006
		<b>List Price</b>	\$660
		<b>Case Quantity</b>	1



HALO TOUCH		Finish Availability	GED 3000
15	Satin Nickel		9GED30000-003
514	Matte Black		9GED30000-004
		<b>List Price</b>	\$660
		<b>Case Quantity</b>	1



HALO TOUCHSCREEN		Finish Availability	GED 2500
15	Satin Nickel		9GED25000-003
514	Matte Black		9GED25000-004
		<b>List Price</b>	\$616
		<b>Case Quantity</b>	1



PREMIS		Finish Availability	GED 2200
15	Satin Nickel		9GED22000-001
514	Matte Black		9GED22000-002
		<b>List Price</b>	\$597
		<b>Case Quantity</b>	2



Product can be locked/unlocked via Wi-Fi



Product can be locked/unlocked via Bluetooth



Product is compatible with Apple HomeKit

SmartKey is standard on all Weiser keyed products

Fire Ratings Available



AURA		Finish Availability	GED 1850
	15	Satin Nickel	9GED18500-001
	514	Matte Black	9GED18500-002
	<b>List Price</b>		\$414
	<b>Case Quantity</b>		1



OBSIDIAN		Finish Availability	GED 2300
	514	Matte Black	9GED23000-001
	<b>List Price</b>		\$497
	<b>Case Quantity</b>		2



SMARTCODE 10 COMMERCIAL LEVER		Finish Availability	GED 2600
	15	Satin Nickel	9GED26000-001
	514	Matte Black	9GED26000-002
	<b>List Price</b>		\$359
	<b>Case Quantity</b>		1



SMARTCODE 10 LEVER		Finish Availability	GED 2700
	15	Satin Nickel	9GED27000-001
	514	Matte Black	9GED27000-002
	<b>List Price</b>		\$352
	<b>Case Quantity</b>		1



Intro

Electronics

Box Pack

Visual Pack

Parts

 SmartKey is standard on all Weiser keyed products

  Fire Ratings Available

 Product can be locked/unlocked via Wi-Fi

 Product can be locked/unlocked via Bluetooth

 Product is compatible with Apple HomeKit

Intro  
Electronics  
Box Pack  
Visual Pack  
Parts

Smartcode Traditional Keypad		Finish Availability	GED 9260
	15	Satin Nickel	9GED92600-001
	514	Matte Black	9GED92600-002
	<b>List Price</b>		\$270
<b>Case Quantity</b>		2	

**MICROBAN**<sup>®</sup>



**20 min.**

Smartcode Contemporary Keypad		Finish Availability	GED 9260
	15	Satin Nickel	9GED92600-003
	26D	Satin Chrome	9GED92600-005
	514	Matte Black	9GED92600-004
<b>List Price</b>		\$270	
<b>Case Quantity</b>		2	

**MICROBAN**<sup>®</sup>





**20 min.**

Smartcode Traditional Touchpad		Finish Availability	GED 9270
	15	Satin Nickel	9GED92700-001
	514	Matte Black	9GED92700-002
	<b>List Price</b>		\$320
<b>Case Quantity</b>		2	





**20 min.**

Smartcode Contemporary Touchpad		Finish Availability	GED 9270
	15	Satin Nickel	9GED92700-003
	514	Matte Black	9GED92700-004
	<b>List Price</b>		\$320
<b>Case Quantity</b>		2	





**20 min.**

 SmartKey is standard on all Weiser keyed products

  Fire Ratings Available

 Product can be locked/unlocked via Wi-Fi

 Product can be locked/unlocked via Bluetooth

 Product is compatible with Apple HomeKit

<b>POWERBOLT 2</b>		Finish Availability	GED 1460
	3BR	Lifetime Brass	9GED14600-101
	11P	Venetian Bronze	9GED14600-102
	15	Satin Nickel	9GED14600-103
	26D	Satin Chrome	9GED14600-104
	514	Matte Black	9GED14600-105
			<b>List Price</b>
		<b>Case Quantity</b>	2



<b>POWERBOLT 1</b>		Finish Availability	GED 1300	
	15	Satin Nickel	9GED13000-001	
	26D	Satin Chrome	9GED13000-002	
	514	Matte Black	9GED13000-003	
			<b>List Price</b>	\$162
			<b>Case Quantity</b>	2

Intro

**Electronics**

Box Pack

Visual Pack

Parts

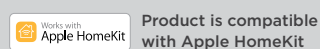
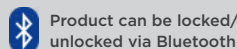
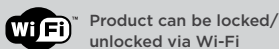
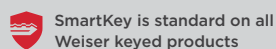

**Prescott x SmartCode  
Traditional Keypad**



Finish Availability		GLA9260 TRL PTH/KAL
15	Satin Nickel	9GLA92600-001
514	Matte Black	9GLA92600-002
		
Interior		Katella
<b>List Price</b>		\$560
<b>Case Quantity</b>		2

MICROBAN<sup>®</sup>



20 min.

**San Clemente x SmartCode  
Contemporary Keypad**



Finish Availability		GLA9260 CNT SCE/HFL
15	Satin Nickel	9GLA92600-003
514	Matte Black	9GLA92600-004
		
Interior		Halifax
<b>List Price</b>		\$560
<b>Case Quantity</b>		2

MICROBAN<sup>®</sup>



20 min.

Intro

Electronics

Box Pack

Visual Pack

Parts

 SmartKey is standard on all Weiser keyed products

  Fire Ratings Available

 Product can be locked/unlocked via Wi-Fi

 Product can be locked/unlocked via Bluetooth

 Product is compatible with Apple HomeKit

All Electronics product meets ASTM E 331 water penetration testing

**HALO TOUCH**

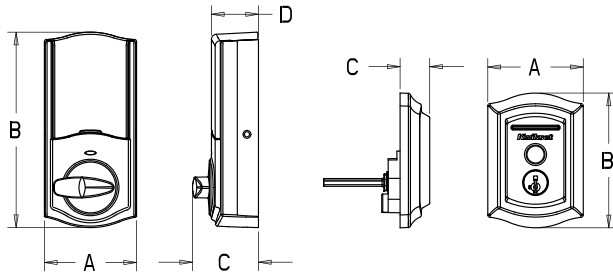

Interior

Exterior

Design	A	B	C	D
Interior	2 <sup>23</sup> / <sub>32</sub> " (69 mm)	5 <sup>25</sup> / <sub>32</sub> " (147 mm)	1 <sup>15</sup> / <sub>16</sub> " (49 mm)	1 <sup>7</sup> / <sub>16</sub> " (35 mm)
Exterior	2 <sup>13</sup> / <sub>16</sub> " (72 mm)	3 <sup>31</sup> / <sub>32</sub> " (101 mm)	<sup>7</sup> / <sub>8</sub> " (22 mm)	---

<b>Function</b>	Single cylinder deadbolt
<b>Door Prep</b>	2 1/8" diameter bore hole & 1" diameter latch hole
<b>Backset</b>	Adjustable 2-3/8" or 2-3/4"
<b>Door Thickness</b>	1-3/4" - 2" automatic adjustment
<b>Faceplates</b>	1" x 2-1/4" square corner standard
<b>Strikes</b>	Square corner strike 2-3/4" x 1-1/8"
<b>Latch</b>	Square & drive-in adjustable 2-3/8" x 2-3/4"
<b>Bolt</b>	1" throw, steel deadbolt
<b>Door Handing</b>	Reversible
<b>Cylinder</b>	SmartKey Security™
<b>Temp Range &amp; Humidity</b>	Temperature Range: Exterior: -40F to 150F Interior: 32F to 130F Humidity: Exterior: 100% condensing Interior: 30% - 95% non-condensing

**HALO TOUCH**

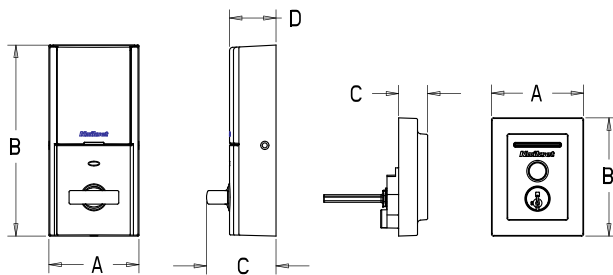

Interior

Exterior

Design	A	B	C	D
Interior	2 <sup>23</sup> / <sub>32</sub> " (69 mm)	5 <sup>25</sup> / <sub>32</sub> " (147 mm)	2 <sup>2</sup> / <sub>32</sub> " (53 mm)	1 <sup>13</sup> / <sub>32</sub> " (36 mm)
Exterior	2 <sup>25</sup> / <sub>32</sub> " (71 mm)	3 <sup>9</sup> / <sub>16</sub> " (91 mm)	<sup>7</sup> / <sub>8</sub> " (22 mm)	---

<b>Function</b>	Single cylinder deadbolt
<b>Door Prep</b>	2 1/8" diameter bore hole & 1" diameter latch hole
<b>Backset</b>	Adjustable 2-3/8" or 2-3/4"
<b>Door Thickness</b>	1-3/4" - 2" automatic adjustment
<b>Faceplates</b>	1" x 2-1/4" square corner standard
<b>Strikes</b>	Square corner strike 2-3/4" x 1-1/8"
<b>Latch</b>	Square & drive-in adjustable 2-3/8" x 2-3/4"
<b>Bolt</b>	1" throw, steel deadbolt
<b>Door Handing</b>	Reversible
<b>Cylinder</b>	SmartKey Security™
<b>Temp Range &amp; Humidity</b>	Temperature Range: Exterior: -40F to 150F Interior: 32F to 130F Humidity: Exterior: 100% condensing Interior: 30% - 95% non-condensing

All Electronics product meets ASTM E 331 water penetration testing

**HALO TOUCHSCREEN**

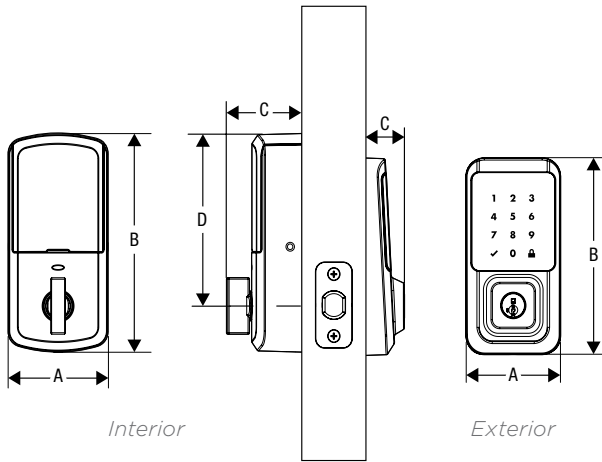

Design	A	B	C	D
Interior	2-3/4" (70 mm)	5-13/16" (147 mm)	2-1/8" (53 mm)	4-9/16" (116 mm)
Exterior	2-28/32" (73 mm)	5-5/8" (143 mm)	1-3/16" (30 mm)	-

<b>Function</b>	Single cylinder deadbolt
<b>Door Prep</b>	2-1/8" diameter bore hole & 1" diameter latch hole
<b>Backset</b>	Adjustable 2-3/8" or 2-3/4"
<b>Door Thickness</b>	1-3/8" - 2" automatic adjustment
<b>Faceplates</b>	1" x 2-1/4" square corner standard
<b>Strikes</b>	Square corner, 4-hole strike, 2-3/4" x 1-1/8"
<b>Latch</b>	Square corner and drive-in adjustable 2-3/4" x 2-1/8"
<b>Bolt</b>	1" throw, steel deadbolt
<b>Door Handing</b>	Reversible
<b>Cylinder</b>	SmartKey®
<b>UL</b>	Meets 20 minute fire rating

**PREMIS**

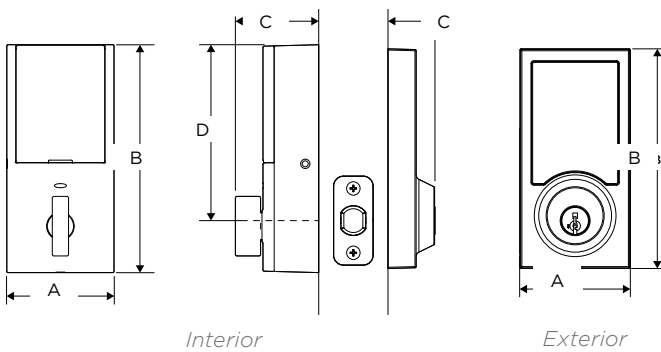

Design	A	B	C	D
Interior	2-3/4" (70 mm)	5-3/4" (146 mm)	1-15/16" (49 mm)	4-9/16" (116 mm)
Exterior	2-13/16" (72 mm)	5-5/8" (143 mm)	1-3/16" (30 mm)	---

<b>Function</b>	Single cylinder deadbolt
<b>Door Prep</b>	2-1/8" diameter bore hole & 1" diameter latch hole
<b>Backset</b>	Adjustable 2-3/8" or 2-3/4"
<b>Door Thickness</b>	1-3/8" - 2" automatic adjustment
<b>Faceplates</b>	1" x 2-1/4" square corner standard
<b>Strikes</b>	Square corner, 4-hole strike, 2-3/4" x 1-1/8"
<b>Latch</b>	Square corner and drive-in adjustable 2-3/8" x 2-3/4"
<b>Bolt</b>	1" throw, steel deadbolt
<b>Door Handing</b>	Reversible
<b>Cylinder</b>	SmartKey®
<b>UL</b>	Meets 20 minute fire rating

All Electronics product meets ASTM E 331 water penetration testing

**AURA**

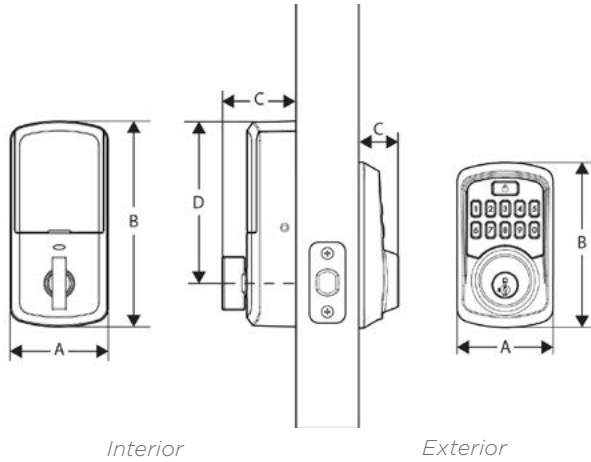

Design	A	B	C	D
Interior	2-1/4"	5-13/16"	2-1/8"	4-9/16"
Exterior	2-23/32"	4-5/8"	1-3/16"	---

<b>Function</b>	Single cylinder deadbolt
<b>Door Prep</b>	2-1/8" diameter bore hole & 1" diameter latch hole
<b>Backset</b>	Adjustable 2-3/8" or 2-3/4"
<b>Door Thickness</b>	1-3/8" - 2" automatic adjustment
<b>Faceplates</b>	1" - 2-3/8" square corner standard
<b>Strikes</b>	Square corner, 4 hole strike, 2-3/4" x 1-1/8"
<b>Latch</b>	Square & drive-in adjustable, 2-3/8" x 2-3/4"
<b>Bolt</b>	1" throw, steel deadbolt
<b>Door Handing</b>	Reversible
<b>Cylinder</b>	SmartKey Security™
<b>UL</b>	Meets 20 minute fire rating

**OBSDIAN**

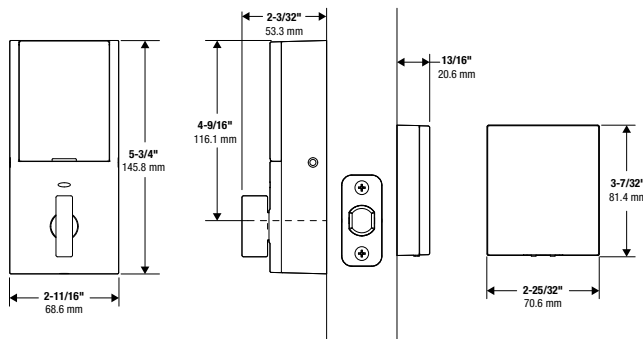

Design	A	B	C	D
Interior	2-11/16" (68 mm)	5-3/4" (146 mm)	2-3/32" (53 mm)	4-9/16" (116 mm)
Exterior	2-25/32" (70 mm)	3-7/32" (82 mm)	4-13/16" (20 mm)	---

<b>Function</b>	Single Cylinder Deadbolt
<b>Door Prep</b>	1-1/2" and 2-1/8" diameter face hole and 1" diameter latch hole
<b>Backset</b>	Adjustable 2-3/8" or 2-3/4"
<b>Door Thickness</b>	1-3/8" - 2"
<b>Faceplates</b>	1" x 2-1/4" square corner standard
<b>Strikes</b>	Square corner
<b>Latch</b>	Square & drive-in adjustable 2-3/8" x 2-3/4"
<b>Bolt</b>	1" throw, steel deadbolt
<b>Door Handing</b>	Reversible
<b>Batteries</b>	6V (4 x AA alkaline batteries required)
<b>UL</b>	Meets 20 minute fire rating

**SMARTCODE 10 COMMERCIAL LEVER**

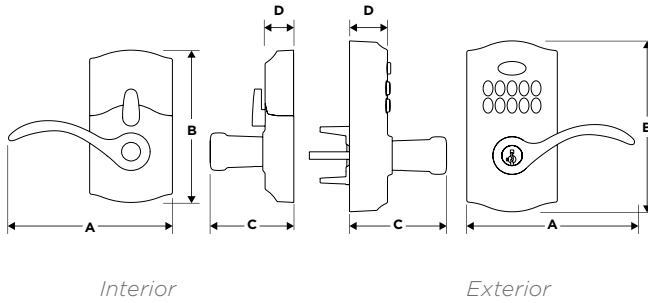

Design	AB		CD	
Interior	5-5/8"	5-5/16"	2-7/8"	31/32"
Exterior	5-3/4"	5-31/32"	3-5/16"	1-13/32"

<b>Function</b>	Keyed entry electronic lever
<b>Door Prep</b>	2-1/8" diameter face hole & 1" diameter latch hole
<b>Backset</b>	Adjustable to 2-3/8" or 2-3/4"
<b>Door Thickness</b>	1-3/8" - 1-3/4"
<b>Faceplates</b>	1" x 2-1/4" Square corner standard
<b>Strikes</b>	Square corner, 4 hole strike, 2-3/4" x 1-1/8"
<b>Latch</b>	Square corner adjustable 2-3/8" x 2-3/4"
<b>Bolt</b>	1/2" throw, dead latch
<b>Door Handing</b>	Reversible
<b>Cylinder</b>	SmartKey Security™
<b>UL</b>	Meets 20 minute fire rating

**SMARTCODE 10 LEVER**

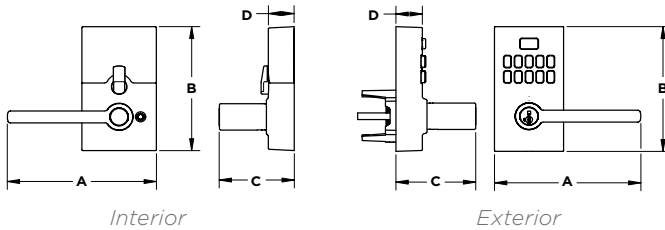

Design	AB		CD	
Interior	5-21/32"	4-7/8"	2-27/32"	31/32"
Exterior	5-9/16"	4-29/32"	3-1/32"	1"

<b>Function</b>	Keyed entry electronic lever
<b>Door Prep</b>	Cross Bore 2-1/8". Edge Bore 1"
<b>Backset</b>	Adjustable to 2-3/8" or 2-3/4"
<b>Door Thickness</b>	1-3/8" - 1-3/4"
<b>Faceplates</b>	1" x 2-1/4" Square corner standard
<b>Strikes</b>	Square corner, 2-1/4" full lip
<b>Latch</b>	Adjustable to 2-3/8" or 2-3/4"
<b>Bolt</b>	1/2" throw, dead latch
<b>Door Handing</b>	Reversible
<b>Cylinder</b>	SmartKey Security™
<b>UL</b>	Meets 20 minute fire rating
<b>Temperature Range</b>	Exterior: -40F to 150F Interior: 32F to 130F
<b>Humidity</b>	Exterior: - 100% condensing Interior: 30% - 95% non-condensing



**SMARTCODE KEYPAD**

*CONTEMPORARY*

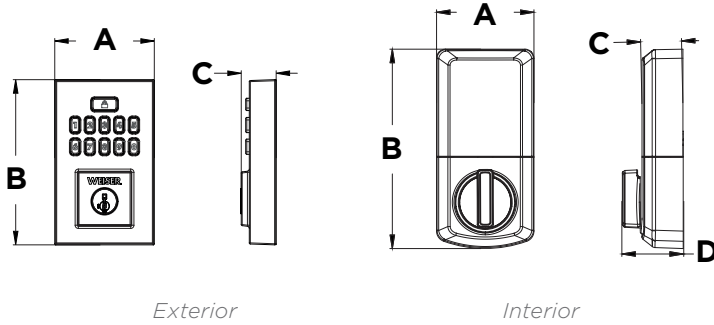

Design	A	B	C	D
Interior	2-3/4" (69 mm)	5-1/2" (140 mm)	1-1/8" (29 mm)	1-11/16" (43.2 mm)
Exterior	2-3/4" (71 mm)	4-9/16" (116 mm)	1" (25 mm)	---

*TRADITIONAL*

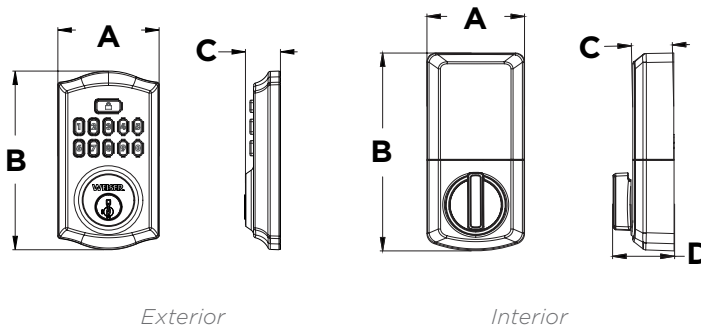

Design	A	B	C	D
Interior	2-3/4" (69 mm)	5-1/2" (140 mm)	1-1/8" (29 mm)	1-11/16" (43.2 mm)
Exterior	2-13/16" (71.7 mm)	5" (127 mm)	1" (25 mm)	---

<b>Battery</b>	Uses 4 x AA 6V alkaline cell batteries with approximately 1 year battery life
<b>Function</b>	Single cylinder deadbolt
<b>Door Prep</b>	1 1/2" (38mm) or 2 1/8" (54mm) diameter cross bore hole and 1" diameter edge bore hole
<b>Backset</b>	Adjustable 2 3/8" (60mm) or 2 3/4" (70mm)
<b>Door Thickness</b>	1 3/8" (35mm) to 1 3/4" (44mm) standard. Thick door service part available for 2-1/4" (57mm) thick doors.
<b>Faceplates</b>	1" (25 mm) x 2 1/4" (57 mm) square corner faceplate with drive-in collar standard
<b>Strikes</b>	2 3/4" (70mm) x 1 1/8" (29mm) square corner 4 hole strike
<b>Bolt</b>	1" (25mm) throw, steel bolt with anti-saw security pin
<b>Door Handing</b>	Reversible
<b>Cylinder</b>	SmartKey Security™
<b>Temperature Range</b>	Exterior: -40°F to 150°F (-40°C to 66°C) Interior: 32°F to 130°F (0°C to 54°C)
<b>Humidity</b>	Exterior: 100% condensing Interior: 30% to 95% non-condensing
<b>Codes</b>	Up to 50 user codes and 10 one-time user codes with optional programming code

All Electronics product meets ASTM E 331 water penetration testing

**SMARTCODE TOUCHPAD**

CONTEMPORARY

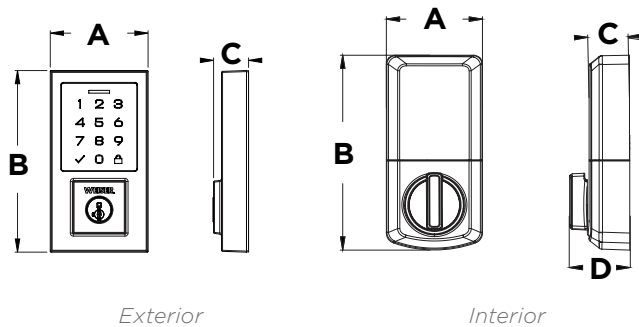

Design	A	B	C	D
Interior	2-3/4" (70 mm)	5-3/16" (132 mm)	1" (25 mm)	---
Exterior	2-3/4" (70 mm)	5-1/2" (140 mm)	1-1/8" (29 mm)	1-11/16" (43 mm)

TRADITIONAL

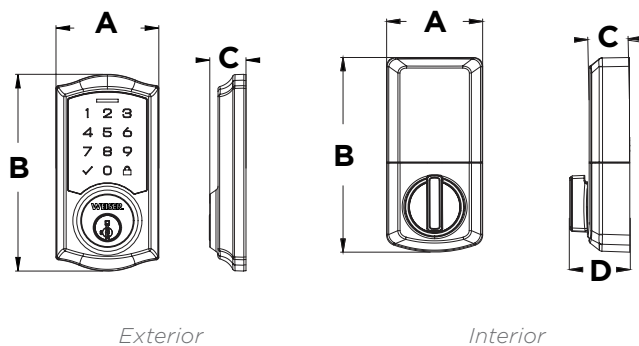

Design	A	B	C	D
Interior	2-13/16" (71 mm)	5-3/8" (137 mm)	1" (25 mm)	---
Exterior	2-3/4" (70 mm)	5-1/2" (140 mm)	1-1/8" (29 mm)	1-11/16" (43 mm)

<b>Battery</b>	Uses 4 x AA 6V alkaline cell batteries with approximately 1 year battery life
<b>Function</b>	Single cylinder deadbolt
<b>Door Prep</b>	1 1/2" (38mm) or 2 1/8" (54mm) diameter cross bore hole and 1" diameter edge bore hole
<b>Backset</b>	Adjustable 2 3/8" (60mm) or 2 3/4" (70mm)
<b>Door Thickness</b>	1 3/8" (35mm) to 1 3/4" (44mm) standard. Thick door service part available for 2-1/4" (57mm) thick doors.
<b>Faceplates</b>	1" (25 mm) x 2 1/4" (57 mm) square corner faceplate with drive-in collar standard
<b>Strikes</b>	2 3/4" (70mm) x 1 1/8" (29mm) square corner 4 hole strike
<b>Bolt</b>	1" (25mm) throw, steel bolt with anti-saw security pin
<b>Door Handing</b>	Reversible
<b>Cylinder</b>	SmartKey Security™
<b>Temperature Range</b>	Exterior: -40°F to 150°F (-40°C to 66°C) Interior: 32°F to 130°F (0°C to 54°C)
<b>Humidity</b>	Exterior: 100% condensing Interior: 30% to 95% non-condensing
<b>Codes</b>	Up to 50 user codes and 10 one-time user codes with optional programming code

Intro  
Electronics  
Box Pack  
Visual Pack  
Parts

**POWERBOLT 2**

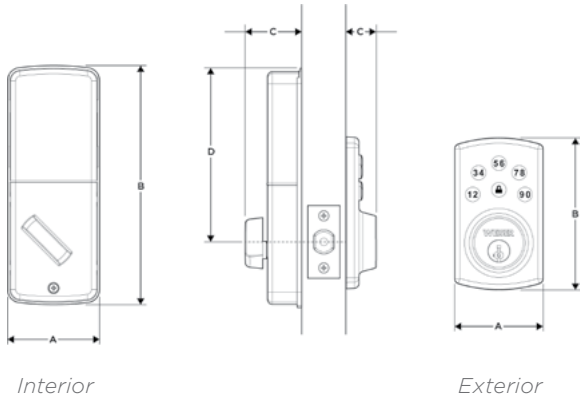

Design	A	B	C	D
Interior	2-7/8"	7-7/16"	1-3/4"	5-15/16"
Exterior	2-3/4"	4-3/4"	1-15/16"	---

<b>Function</b>	Single cylinder deadbolt
<b>Door Prep</b>	2 1/8" diameter face hole & 1" diameter latch hole
<b>Backset</b>	Adjustable 2 3/8" or 2 3/4"
<b>Door Thickness</b>	1 3/8" - 2" automatic adjustment
<b>Faceplates</b>	1" x 2 1/4" square corner standard
<b>Strikes</b>	Square corner strike 2 3/4" x 1 1/8"
<b>Latch</b>	Square & drive-in adjustable 2 3/8" x 2 3/4"
<b>Bolt</b>	1" throw, steel deadbolt
<b>Door Handing</b>	Reversible
<b>Cylinder</b>	SmartKey®

**POWERBOLT 1**

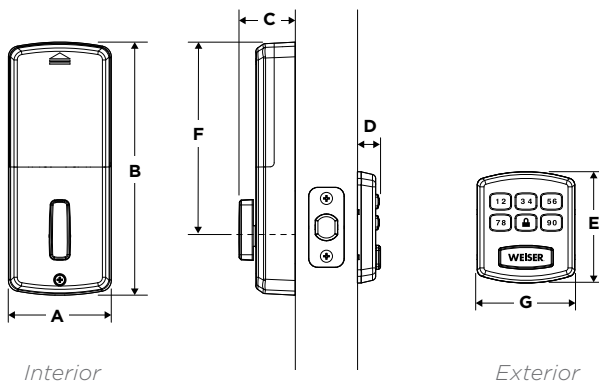

Design	A	B	C	D	E	F	G
Interior	3" (76 mm)	7-3/8" (187 mm)	1-21/32" (42 mm)	11/36" (8 mm)	-	5-19/32" (142 mm)	-
Exterior	-	-	-	-	3-1/4" (95 mm)	-	2-27/32" (72 mm)

<b>Function</b>	Single cylinder deadbolt
<b>Door Prep</b>	2-1/8" diameter face hole & 1" diameter latch hole
<b>Latch</b>	Square and drive-in adjustable 2-3/8" or 2-3/4"
<b>Door Thickness</b>	Fits 1-3/8" - 1-3/4" door thickness
<b>Latch Faceplate</b>	1" x 2-1/4" square corner standard
<b>Strike</b>	Square corner strike 2-3/4" x 1-1/8"
<b>Bolt</b>	1" throw, steel deadbolt
<b>Door Handing</b>	Reversible
<b>Batteries</b>	Requires 4 X AA alkaline batteries





**BOX PACK**

# Pfister

## BATH HARDWARE PROGRAM

Introducing the Pfister Bath Hardware Program. With multiple designs and finishes to choose from pairing your bath accessories to your Weiser door hardware is as easy as ever. Simply work with your Weiser rep to start placing your Pfister bath accessory orders.







Contact your Weiser Rep for pricing and to order today



Our in-stock program of 2 families bothin 3 different finishes ensures timely delivery on the most popular design trends. Our full line of accessories are also available for custom order to ensure the perfect finish and design match for your project.

# PFIRST MODERN

Pfirst Modern effortlessly combines clean lines with contemporary curves to create an up-to-date, modern style statement for any bathroom project.





	Model	Finish	Case Qty
<b>18" Towel Bar</b> 	BTB-PFM1C	Polished Chrome	3
	BTB-PFM1GS	Brushed Nickel	3
	BTB-PFM1B	Matte Black	3
<b>24" Towel Bar</b> 	BTB-PFM2C	Polished Chrome	3
	BTB-PFM2GS	Brushed Nickel	3
	BTB-PFM2B	Matte Black	3
<b>Robe Hook</b> 	BRH-PFM0C	Polished Chrome	3
	BRH-PFM0GS	Brushed Nickel	3
	BRH-PFM0B	Matte Black	3
<b>Paper Holder</b> 	BPH-PFM0C	Polished Chrome	3
	BPH-PFM0GS	Brushed Nickel	3
	BPH-PFM0B	Matte Black	3
<b>Towel Ring</b> 	BRB-PFM0C	Polished Chrome	3
	BRB-PFM0GS	Brushed Nickel	3
	BRB-PFM0B	Matte Black	3



Contact your Weiser Rep for pricing and to order today

# DECKARD

The clean, horizontal lines in this design create a precise aesthetic as the contrasting subtle curves offer balance.

	Model	Finish	Case Qty
<b>18" Towel Bar</b> 	BTB-DA1C	Polished Chrome	3
	BTB-DA1K	Brushed Nickel	3
	BTB-DA1B	Matte Black	3
<b>24" Towel Bar</b> 	BTB-DA2C	Polished Chrome	3
	BTB-DA2K	Brushed Nickel	3
	BTB-DA2B	Matte Black	3
<b>Robe Hook</b> 	BRH-DA1C	Polished Chrome	3
	BRH-DA1K	Brushed Nickel	3
	BRH-DA1B	Matte Black	3
<b>Paper Holder</b> 	BPH-DA1C	Polished Chrome	3
	BPH-DA1K	Brushed Nickel	3
	BPH-DA1B	Matte Black	3
<b>Towel Ring</b> 	BRB-DA1C	Polished Chrome	3
	BRB-DA1K	Brushed Nickel	3
	BRB-DA1B	Matte Black	3

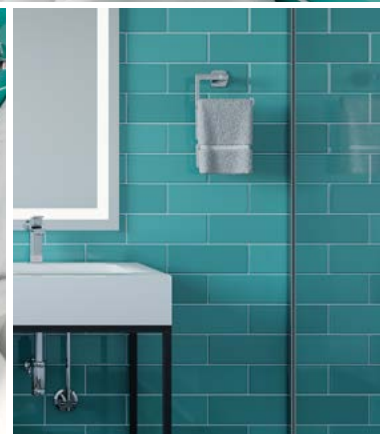

Intro

Electronics

Box Pack

Visual Pack

Parts

HANDLESETS GROUP A	Function	GA 9771 Single Cylinder	GA 71 Inactive
	List Price		\$366

ASHFIELD	Finish Availability	GA9771 ADH	GA71 ADH
	15 Satin Nickel	MTO	MTO
	514 Matte Black	9GA97710-035	MTO
<b>Case Quantity</b>		4	4



AVALON	Finish Availability	GA9771 AVH	GA71 AVH
	15 Satin Nickel	9GA97710-034	MTO
	<b>Case Quantity</b>	4	4



TAVARIS	Finish Availability	GA9771 TVH	GA71 TVH
	15 Satin Nickel	9GA97710-030	MTO
	26 Polished Chrome	9GA97710-031	MTO
	26D Satin Chrome	9GA97710-032	MTO
	514 Matte Black	9GA97710-026	MTO
<b>Case Quantity</b>		4	4



Note: Microban is available on the following finishes: 15, 514

NOTE: All box pack handlesets are ordered LESS INTERIOR PACK (LIP). Interior packs must be ordered separately.



HANDLESETS GROUP A	Function	GA 8771 Single Cylinder	GA 7771 Handleset Minus	GA 61 Inactive
	List Price	\$366	\$285	\$306

SAN CLEMENTE	Finish Availability	GA8771 SCE	GA7771 SCE/HFL ONLY	GA61 SCE
	15 Satin Nickel	9GA87710-001	9GLA77710-007**	MTO
	26 Polished Chrome	MTO	MTO***	MTO
	26D Satin Chrome	9GA87710-002	MTO***	MTO
	514 Matte Black	9GA87710-003	9GLA77710-001**	MTO
	<b>Case Quantity</b>		4	4

\* Compatible with 8675 interior packs only.  
 GA7771 ships without deadbolt for pairing with an electronics deadbolt.  
 \*\* Visual Pack packaging  
 \*\*\* Pricing for MTO items is \$272

**Note:** Microban is available on the following finishes: 15, 514

**MICROBAN**



VANCOUVER	Finish Availability	GA8771 VNH	GA61 VNH
	15 Satin Nickel	9GA87710-007	MTO
	26 Polished Chrome	MTO	MTO
	514 Matte Black	9GA87710-008	MTO
	<b>Case Quantity</b>	4	4

\* Compatible with 8675 interior packs only  
**Note:** Microban is available on the following finishes: 15, 514

**MICROBAN**



**NOTE:** All box pack handlesets are ordered LESS INTERIOR PACK (LIP). Interior packs must be ordered separately.

\*Halifax Full Trim Escutcheon available for Vancouver Handleset only. See Page 41 for SKU number.



Intro

Electronics

Box Pack

Visual Pack

Parts

HANDLESETS GROUP A	Function	GA 8771 Single Cylinder	GA 61 Inactive
	List Price		\$366

PRAGUE	Finish Availability		GA8771 PGH	GA61 PGH
	15	Satin Nickel	9GA87710-009	MTO
	514	Matte Black	9GA87710-010	MTO
	<b>Case Quantity</b>		6	6

\* Compatible with 8675 interior packs only



HANDLESETS GROUP B	Function	GA 9771 Single Cylinder	GA 7771 Handleset Minus	GA 71 Inactive
	List Price		\$330	\$285

AUGUSTA	Finish Availability		GA9771 A	GA71 A
	15	Satin Nickel	9GA97710-003	MTO
	26D	Satin Chrome	9GA97710-005	MTO
	<b>Case Quantity</b>		6	6

Note: Microban is available on the following finishes: 15



HAWTHORNE	Finish Availability		GA9771 HE	GA7771 HE/TC	GA71 HE
	11P	Venetian Bronze	9GA97710-022	9GLA77710-004*	MTO
	15	Satin Nickel	9GA97710-025		MTO
	<b>Case Quantity</b>		6	6	6

\* Visual Pack packaging



NOTE: All box pack handlesets are ordered LESS INTERIOR PACK (LIP). Interior packs must be ordered separately.

Function	GLA/SIP 9675 Single Cylinder	GLA/SIP 8675* Single Cylinder	GLA 8675* Full Escutcheon	GLA/SIP 96 Inactive	GLA 86 Inactive
List Price	\$76	\$76	\$96	\$76	\$76

\*Compatible with San Clemente & Vancouver Only

LEVERS	3	5	11P	15	15A	26	26D	514	QTY
Ashfield - Square Faced Latch								9GLA96750-095	4
Ashfield - Drive-in Latch				MTO				9GLA96750-096	4
Aspen			9GLA96750-123					MTO	4
Avalon Left Handed - Square Faced Latch				9GLA96750-097					4
Avalon Right Handed - Square Faced Latch				9GLA96750-098					4
Avalon Left Handed - Drive-in Latch				9GLA96750-099					4
Avalon Right Handed - Drive-in Latch				9GLA96750-100					4
Breton - Round Rose				MTO		MTO		MTO	4
Breton - Square Rose				9GLA96750-174		MTO	9GLA96750-175	MTO	4
Breton - Round Rose 8675*				MTO		MTO		MTO	4
Breton - Square Rose 8675*				MTO		MTO	MTO	MTO	4
Galiano							MTO		4
Halifax - Round Rose			MTO	9GLA96750-147		9GLA96750-149	MTO	9GLA96750-152	12
Halifax - Square Rose			9GLA96750-146	9GLA96750-148		9GLA96750-150	9GLA96750-151	9GLA96750-153	12
Halifax - Square Rose 8675*			MTO	9GLA86750-001		MTO	9GLA86750-002	9GLA86750-003	4
Halifax - Round Rose 8675*			MTO	MTO		MTO	MTO	MTO	4
Halifax - Full Escutcheon 8675*				9GLA86750-021		MTO		9GLA86750-022	4
Katella				9GLA96750-179				9GLA96750-180	
Kim				9GLA96750-133			MTO		
Lisbon - Round Rose				9GLA96750-169		MTO		MTO	12
Lisbon - Square Rose				9GLA96750-170				9GLA96750-173	12

Intro

Electronics

Box Pack

Visual Pack

Parts

**HANDLESETS INTERIOR PACK**

Function	GLA/SIP 9675 Single Cylinder	GLA/SIP 8675* Single Cylinder	GLA 8675* Full Escutcheon	GLA/SIP 96 Inactive	GLA 86 Inactive
List Price	\$76	\$76	\$96	\$76	\$76

\*Compatible with San Clemente & Vancouver Only

LEVERS	3	5	11P	15	15A	26	26D	514	QTY
Lisbon - Square Rose 8675*				9GLA86750-017				9GLA86750-018	4
Lisbon - Round Rose 8675*				MTO		MTO		MTO	4
Milan - Square Rose				MTO		MTO	MTO	MTO	12
Milan - Square Rose 8675*				MTO		MTO	MTO	MTO	4
Milan - Round Rose 8675*				MTO		MTO	MTO	MTO	4
Montreal - Round Rose				MTO					12
Montreal - Square Rose				9GLA96750-157				9GLA96750-159	12
Montreal - Square Rose 8675*				9GLA86750-016				MTO	4
Montreal - Round Rose 8675*				MTO					4
Prague 8675*				9GLA86750-026		9GLA86750-028	9GLA86750-029	9GLA86750-027	4
Singapore - Round Rose				MTO		MTO		MTO	4
Singapore - Square Rose				9GLA96750-176		9GLA96750-178	MTO	9GLA96750-177	4
Singapore - Round Rose 8675*				MTO		MTO		MTO	4
Singapore - Square Rose 8675*				9GLA86750-023		9GLA86750-025	MTO	9GLA86750-024	4
Sydney - Round Rose				MTO				MTO	12
Sydney - Square Rose				MTO				MTO	12
Sydney - Square Rose 8675*				MTO				MTO	12
Sydney - Round Rose 8675*				MTO				MTO	12
Toluca Left Handed	MTO		MTO	9GLA96750-136	MTO		MTO	MTO	4
Toluca Right Handed	MTO		MTO	9GLA96750-137	MTO		MTO	MTO	4

Intro

Electronics

Box Pack

Visual Pack

Parts

Function	GA 9675 Single Cylinder	GLA 8675* Single Cylinder	GA 96 Inactive
List Price	\$76	\$76	\$76

\*Compatible with San Clemente & Vancouver Only

KNOBS	3	5	11P	15	15A	26	26D	514	QTY
Cambie - Round Rose				9GA96750-107		MTO	MTO	9GA96750-108	4
Cambie - Square Rose				9GA96750-105		MTO	MTO	9GA96750-106	4
Cambie - Round Rose 8675*				9GA86750-003		MTO	MTO	9GA86750-004	4
Cambie - Square Rose 8675*				9GA86750-001		MTO	MTO	9GA86750-002	4
Fairfax							9GA96750-075		4
Huntington				9GA96750-076			9GA96750-077		4
Phoenix				MTO					4
Prague				9GA86750-005		9GA86750-007	9GA86750-008	9GA86750-006	4
Troy			MTO	9GA96750-086			9GA96750-088	9GA96750-090	4

Intro

Electronics

Box Pack

Visual Pack

Parts

LEVERS GROUP A	Function	101 Hall/Closet	331 Bed/Bath	535 Keyed Entry	12 Inactive LH	12 Inactive RH
	List Price	\$101	\$118	\$171	\$64	\$64

ASHFIELD	Finish Availability	GLA 101 ADL	GLA 331 ADL	GLA 535 ADL	GLA 12 ADL
	15 Satin Nickel	MTO	MTO	MTO	MTO
	514 Matte Black	9GLA1010-105	9GLA3310-104	9GLA5350-152	9GLA120-092
	Case Quantity	12	12	12	6

MICROBAN







AVALON	Finish Availability	GLA 101 AVL	GLA 331 AVL	GLA 535 AVL	GLA 12 AVL LH	GLA 12 AVL RH
	15 Satin Nickel	9GLA1010-110	9GLA3310-106	9GLA5350-153	9GLA120-095	9GLA120-096
	Case Quantity	12	12	12	6	6

MICROBAN







Intro  
Electronics  
Box Pack  
Visual Pack  
Parts

LEVERS GROUP B	Function	101 Hall/Closet	101 Hall/Closet 3HR UL	331 Bed/Bath	535 Keyed Entry	12 Inactive
	List Price	\$88	\$108	\$105	\$158	\$53

SINGAPORE - SQUARE ROSE	Finish Availability	GLA 101 SAL	GLA 101 SAL UL	GLA 331 SAL	GLA 535 SAL	GLA 12 SAL
    	15 Satin Nickel	9GLA1010-120	MTO	9GLA3310-119	9GLA5350-166	9GLA120-114
	26 Polished Chrome	9GLA1010-122	MTO	9GLA3310-121	9GLA5350-168	9GLA120-116
	26D Satin Chrome	MTO	MTO	MTO	MTO	MTO
	514 Matte Black	9GLA1010-121	MTO	9GLA3310-120	9GLA5350-167	9GLA120-115
<b>Case Quantity</b>		12	12	12	12	6

**Note:** Microban is available on the following finishes: 15, 514  
 Thick door models can be ordered through MTO. Thick door kit service parts are not compatible with these models.

SINGAPORE - ROUND ROSE	Finish Availability	GLA 101 SAL	GLA 101 SAL UL	GLA 331 SAL	GLA 535 SAL	GLA 12 SAL
    	15 Satin Nickel	9GLA1010-123	MTO	9GLA3310-122	MTO	9GLA120-117
	26 Polished Chrome	9GLA1010-124	MTO	9GLA3310-123	MTO	9GLA120-118
	514 Matte Black	MTO	MTO	MTO	MTO	MTO
	<b>Case Quantity</b>		12	12	12	12

**Note:** Microban is available on the following finishes: 15, 514  
 Thick door models can be ordered through MTO. Thick door kit service parts are not compatible with these models.

Intro

Electronics

Box Pack

Visual Pack

Parts

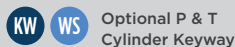
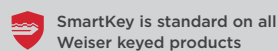

MTO = Made To Order

Intro  
Electronics  
Box Pack  
Visual Pack  
Parts

<b>LEVERS GROUP B</b>	<b>Function</b>	101 Hall/Closet	331 Bed/Bath	535 Keyed Entry	12 Inactive
	<b>List Price</b>	\$88	\$105	\$158	\$53

<b>ASPEN</b>	Finish Availability	GLA 101 A	GLA 331 A	GLA 535 A	GLA 12 A
	11P Venetian Bronze	9GLA1010-107	9GLA3310-111	9GLA5350-149	9GLA120-101
	514 Matte Black	MTO	MTO	MTO	MTO
	<b>Case Quantity</b>	12	12	12	6



<b>DANE</b>	Finish Availability	GLA 101 D	GLA 331 D	GLA 535 D	GLA 12 D
	26D Satin Chrome	MTO	MTO	MTO	MTO
	<b>Case Quantity</b>	12	12	12	12



<b>GALIANO</b>	Finish Availability	GLA 101 G	GLA 331 G	GLA 535 G	GLA 12 G
	26D Satin Chrome	MTO	MTO	MTO	MTO
	<b>Case Quantity</b>	12	12	12	6



<b>LEVERS GROUP C</b>	<b>Function</b>	101 Hall/Closet	331 Bed/Bath	535 Keyed Entry	12 Inactive
	<b>List Price</b>	\$81	\$98	\$154	\$49

<b>PRAGUE - MODERN ROSE</b>	Finish Availability	GLA 101 PGL	GLA 331 PGL	GLA 535 PGL	GLA 12 PGL
	15 Satin Nickel	9GLA1010-139	9GLA3310-138	MTO	9GLA120-133
	26 Polished Chrome	9GLA1010-141	9GLA3310-140	MTO	9GLA120-135
	26D Satin Chrome	9GLA1010-142	9GLA3310-141	MTO	9GLA120-136
	514 Matte Black	9GLA1010-140	9GLA3310-139	MTO	9GLA120-134
	<b>Case Quantity</b>	12	12	12	6



Note: Microban is available on the following finishes: 15, 514



LEVERS GROUP C	Function	101 Hall/Closet	331 Bed/Bath	535 Keyed Entry	12 Inactive
	List Price	\$81	\$98	\$154	\$49

HALIFAX	Finish Availability	GLA 101 HFL	GLA 331 HFL	GLA 535 HFL	GLA 12 HFL
	4 Satin Brass	9GLA1010-152	9GLA3310-145	9GLA5350-186	9GLA120-138
	<b>Case Quantity</b>	12	12	12	6



LEVERS GROUP D	Function	101 Hall/Closet	331 Bed/Bath	535 Keyed Entry	12 Inactive
	List Price	\$77	\$94	\$147	\$46

HALIFAX - SQUARE ROSE	Finish Availability	GLA 101 HFL	GLA 331 HFL	GLA 535 HFL	GLA 12 HFL
	11P Venetian Bronze	9GLA1010-076	9GLA3310-075	9GLA5350-105	9GLA120-068
	15 Satin Nickel	9GLA1010-059	9GLA3310-058	9GLA5350-088	9GLA120-047
	26 Polished Chrome	9GLA1010-079	9GLA3310-078	9GLA5350-107	9GLA120-071
	26D Satin Chrome	9GLA1010-080	9GLA3310-079	9GLA5350-109	9GLA120-072
	514 Matte Black	9GLA1010-082	9GLA3310-081	9GLA5350-110	9GLA120-074
<b>Case Quantity</b>		12	12	12	20



**Note:** Microban is available on the following finishes: 11P, 15, 514  
Thick door models can be ordered through MTO. Thick door kit service parts are not compatible with these models.

LEVERS GROUP D	Function	101 Hall/Closet FD	101 Hall/Closet UL
	List Price	\$83.50	\$97

HALIFAX - SQUARE ROSE	Finish Availability	GLA 101 HFL FD	GLA 101 HFL UL
	11P Venetian Bronze		MTO
	15 Satin Nickel	9GLA1010-143	MTO
	26 Polished Chrome	9GLA1010-144	MTO
	514 Matte Black	9GLA1010-145	MTO
<b>Case Quantity</b>		12	12



**Note:** Microban is available on the following finishes: 11P, 15, 514  
Thick door models can be ordered through MTO. Thick door kit service parts are not compatible with these models.

Intro

Electronics

Box Pack

Visual Pack

Parts

LEVERS GROUP D	Function	101 Hall/Closet	331 Bed/Bath	535 Keyed Entry	12 Inactive
	List Price	\$77	\$94	\$147	\$46

HALIFAX - ROUND ROSE	Finish Availability	GLA 101 HFL	GLA 331 HFL	GLA 535 HFL	GLA 12 HFL
	11P Venetian Bronze	MTO	MTO	MTO	MTO
	15 Satin Nickel	9GLA1010-077	9GLA3310-076	9GLA5350-106	9GLA120-069
	26 Polished Chrome	9GLA1010-078	9GLA3310-077	9GLA5350-108	9GLA120-070
	26D Satin Chrome	MTO	MTO	MTO	MTO
	514 Matte Black	9GLA1010-081	9GLA3310-080	9GLA5350-111	9GLA120-073
<b>Case Quantity</b>		12	12	12	20

MICROBAN



Note: Microban is available on the following finishes: 11P, 15, 514  
Thick door models can be ordered through MTO. Thick door kit service parts are not compatible with these models.

LEVERS GROUP D	Function	101 Hall/Closet FD	101 Hall/Closet UL
	List Price	\$83.50	\$97

HALIFAX - ROUND ROSE	Finish Availability	GLA 101 HFL FD	GLA 101 HFL UL
	11P Venetian Bronze		MTO
	15 Satin Nickel	9GLA1010-146	MTO
	26 Polished Chrome	9GLA1010-147	MTO
	26D Satin Chrome		MTO
	514 Matte Black	9GLA1010-148	MTO
<b>Case Quantity</b>		12	12

MICROBAN



Note: Microban is available on the following finishes: 11P, 15, 514  
Thick door models can be ordered through MTO. Thick door kit service parts are not compatible with these models.

LEVERS GROUP D	Function	101 Hall/Closet	331 Bed/Bath	535 Keyed Entry	12 Inactive
	List Price	\$77	\$94	\$147	\$46

LISBON - SQUARE ROSE	Finish Availability	GLA 101 LSL	GLA 331 LSL	GLA 535 LSL	GLA 12 LSL
	15 Satin Nickel	9GLA1010-095	9GLA3310-094	9GLA5350-123	9GLA120-087
	514 Matte Black	9GLA1010-098	9GLA3310-097	9GLA5350-127	9GLA120-090
	<b>Case Quantity</b>	12	12	12	20

MICROBAN



SmartKey is standard on all Weiser keyed products

MICROBAN Product is Microban coated

KW WS Optional P & T Cylinder Keyway

Fire Ratings Available

MTO = Made To Order

LEVERS GROUP D	Function	101 Hall/Closet	331 Bed/Bath	535 Keyed Entry	12 Inactive
	List Price	\$77	\$94	\$147	\$46

LISBON - ROUND ROSE	Finish Availability	GLA 101 LSL	GLA 331 LSL	GLA 535 LSL	GLA 12 LSL
	15 Satin Nickel	9GLA1010-094	9GLA3310-093	9GLA5350-124	9GLA120-086
	26 Polished Chrome	MT0	MT0	MT0	MT0
	514 Matte Black	MT0	MT0	MT0	MT0
	<b>Case Quantity</b>	12	12	12	20

**Note:** Microban is available on the following finishes: 15, 514



MILAN - SQUARE ROSE	Finish Availability	GLA 101 MIL	GLA 331 MIL	GLA 535 MIL	GLA 12 MIL
	15 Satin Nickel	9GLA1010-125	9GLA3310-124	9GLA5350-169	9GLA120-119
	26 Polished Chrome	MT0	MT0	MT0	MT0
	26D Satin Chrome	MT0	MT0	MT0	MT0
	514 Matte Black	9GLA1010-128	9GLA3310-127	9GLA5350-172	9GLA120-122
<b>Case Quantity</b>	12	12	12	20	

**Note:** Microban is available on the following finishes: 15, 514



MILAN - ROUND ROSE	Finish Availability	GLA 101 MIL	GLA 331 MIL	GLA 535 MIL	GLA 12 MIL
	15 Satin Nickel	9GLA1010-083	9GLA3310-082	9GLA5350-112	9GLA120-075
	26 Polished Chrome	9GLA1010-084	9GLA3310-083	9GLA5350-113	9GLA120-076
	26D Satin Chrome	9GLA1010-085	9GLA3310-084	9GLA5350-114	9GLA120-077
	514 Matte Black	9GLA1010-127	9GLA3310-126	9GLA5350-171	9GLA120-121
<b>Case Quantity</b>	12	12	12	20	

**Note:** Microban is available on the following finishes: 15, 514



MONTREAL - SQUARE ROSE	Finish Availability	GLA 101 MRL	GLA 331 MRL	GLA 535 MRL	GLA 12 MRL
	15 Satin Nickel	9GLA1010-086	9GLA3310-085	9GLA5350-115	9GLA120-078
	514 Matte Black	9GLA1010-088	9GLA3310-087	9GLA5350-117	9GLA120-080
	<b>Case Quantity</b>	12	12	12	20



MONTREAL - ROUND ROSE	Finish Availability	GLA 101 MRL	GLA 331 MRL	GLA 535 MRL	GLA 12 MRL
	15 Satin Nickel	MT0	MT0	MT0	MT0
	<b>Case Quantity</b>	12	12	12	20



Intro

Electronics

Box Pack

Visual Pack

Parts

LEVERS GROUP D	Function	101 Hall/Closet	331 Bed/Bath	535 Keyed Entry	12 Inactive
	List Price	\$77	\$94	\$147	\$46

SYDNEY - SQUARE ROSE	Finish Availability	GLA 101 SYL	GLA 331 SYL	GLA 535 SYL	GLA 12 SYL
	15 Satin Nickel	MTO	MTO	MTO	MTO
	514 Matte Black	MTO	MTO	MTO	MTO
<b>Case Quantity</b>		12	12	12	20



SYDNEY - ROUND ROSE	Finish Availability	GLA 101 SYL	GLA 331 SYL	GLA 535 SYL	GLA 12 SYL
	15 Satin Nickel	9GLA1010-089	9GLA3310-088	9GLA5350-118	9GLA120-081
	514 Matte Black	MTO	MTO	MTO	MTO
<b>Case Quantity</b>		12	12	12	20



KATELLA	Finish Availability	GLA 101 KAL	GLA 331 KAL	GLA 535 KAL	GLA 12 KAL
	15 Satin Nickel	9GLA1010-130	9GLA3310-129	9GLA5350-174	9GLA120-124
	514 Matte Black	9GLA1010-131	9GLA3310-130	9GLA5350-175	9GLA120-125
<b>Case Quantity</b>		12	12	12	6



LEVERS GROUP E	Function	101 Hall/Closet	331 Bed/Bath	535 Keyed Entry	12 Inactive LH	12 Inactive RH
	List Price	\$73	\$90	\$143	\$38	\$38

TOLUCA	Finish Availability	GLA 101 TC	GLA 331 TC	GLA 535 TC	GLA 12 TC LH	GLA 12 TC RH
	3 Brass	MTO	MTO		MTO	MTO
	3BR Lifetime Brass			MTO		
	11P Venetian Bronze	MTO	MTO	MTO	MTO	MTO
	15 Satin Nickel	9GLA1010-114	9GLA3310-113	9GLA5350-157	9GLA120-103	9GLA120-104
	15A Antique Nickel	MTO	MTO	MTO	MTO	MTO
	26D Satin Chrome	MTO	MTO	MTO	MTO	MTO
	514 Matte Black	MTO	MTO	MTO	MTO	MTO
<b>Case Quantity</b>		12	12	12	6	6



Note: Microban is available on the following finishes: 3, 11P, 15, 15A, 514

<b>KNOBS GROUP A</b>	<b>Function</b>	101 Hall/Closet	331 Bed/Bath	531 Keyed Entry	12 Inactive
	<b>List Price</b>	\$66	\$83	\$139	\$33

<b>PRAGUE - MODERN ROSE</b>	Finish Availability	GLA 101 PGK	GLA 331 PGK	GLA 531 PGK	GLA 12 PGK
	15 Satin Nickel	9GA1010-155	9GA3310-158	MTO	9GA120-102
	26 Polished Chrome	MTO	MTO	MTO	MTO
	26D Satin Chrome	MTO	MTO	MTO	MTO
	514 Matte Black	9GA1010-156	9GA3310-159	MTO	9GA120-103
	<b>Case Quantity</b>	12	12	12	6

Note: Microban is available on the following finishes: 15, 514

**MICROBAN**



<b>KNOBS GROUP B</b>	<b>Function</b>	101 Hall/Closet	331 Bed/Bath	531 Keyed Entry	12 Inactive
	<b>List Price</b>	\$62	\$79	\$132	\$30

<b>CAMBIE - SQUARE ROSE</b>	Finish Availability	GA 101 CBK	GA 331 CBK	GA 531 CBK	GA 12 CBK
	15 Satin Nickel	9GA1010-149	9GA3310-152	9GA5310-195	9GA120-096
	26 Polished Chrome	MTO	MTO	MTO	MTO
	26D Satin Chrome	MTO	MTO	MTO	MTO
	514 Matte Black	9GA1010-150	9GA3310-153	9GA5310-197	9GA120-097
	<b>Case Quantity</b>	12	12	12	6

Note: Microban is available on the following finishes: 15, 514

**MICROBAN**



<b>CAMBIE - ROUND ROSE</b>	Finish Availability	GA 101 CBK	GA 331 CBK	GA 531 CBK	GA 12 CBK
	15 Satin Nickel	9GA1010-151	9GA3310-154	9GA5310-194	9GA120-098
	26 Polished Chrome	MTO	MTO	MTO	MTO
	26D Satin Chrome	MTO	MTO	MTO	MTO
	514 Matte Black	9GA1010-152	9GA3310-155	9GA5310-196	9GA120-099
	<b>Case Quantity</b>	12	12	12	6

Note: Microban is available on the following finishes: 15, 514

**MICROBAN**



Intro

Electronics

Box Pack

Visual Pack

Parts

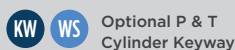
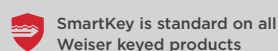

MTO = Made To Order

Intro  
Electronics  
Box Pack  
Visual Pack  
Parts

KNOBS GROUP C	Function	101 Hall/Closet	331 Bed/Bath	531 Keyed Entry	12 Inactive	581 Storeroom
	List Price	\$56	\$73	\$126	\$30	\$165

HUNTINGTON	Finish Availability	GA 101 HT	GA 331 HT	GA 531 HT	GA 12 HT	GA 581 HT
	15 Satin Nickel	9GA1010-129	9GA3310-125	9GA5310-200	9GA120-083	MTO
	26D Satin Chrome	9GA1010-130	9GA3310-126	9GA5310-201	9GA120-084	MTO
	<b>Case Quantity</b>	12	12	12	6	12

Note: Microban is available on the following finishes: 15



PHOENIX	Finish Availability	GA 101 P	GA 331 P	GA 531 P	GA 12 P	GA 581 P
	15 Satin Nickel	9GA1010-132	9GA3310-128	9GA5310-204	9GA120-086	MTO
	<b>Case Quantity</b>	12	12	12	6	12



HANCOCK	Finish Availability	GA 101 H	GA 331 H	GA 531 H	GA 12 H
	15 Satin Nickel	MTO	MTO	MTO	MTO
	26D Satin Chrome	MTO	MTO	MTO	MTO
	<b>Case Quantity</b>	12	12	12	6

Note: Microban is available on the following finishes: 15



KNOBS GROUP D	Function	101 Hall/Closet	331 Bed/Bath	531 Keyed Entry	12 Inactive*	581 Storeroom
	List Price	\$48	\$65	\$118	\$24	\$156

TROY	Finish Availability	GA 101 T	GA 331 T	GA 531 T	GA 12 T	GA 581 T
	11P Venetian Bronze	MTO	MTO	MTO	MTO	MTO
	15 Satin Nickel	9GA1010-133	9GA3310-129	9GA5310-207	9GA120-087	MTO
	26D Satin Chrome	9GA1010-128	9GA3310-124	9GA5310-209	9GA120-082	MTO
	514 Matte Black	9GA1010-134	9GA3310-130	9GA5310-210	9GA120-088	MTO
	<b>Case Quantity</b>	12	12	12	6	12

Note: Microban is available on the following finishes: 11P, 15, 514

\*Inactive knob fits on 1-3/4" thick door only.

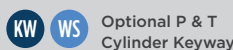
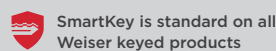

MTO = Made To Order

DOWNTOWN GD 1471 - SQUARE		Finish Availability	GD 1471 Single Cylinder
	4	Satin Brass	9GD14710-040
	15	Satin Nickel	9GD14710-026
	26	Polished Chrome	9GD14710-027
	26D	Satin Chrome	MTO
	514	Matte Black	9GD14710-031
	<b>List Price</b>		\$109
<b>Case Quantity</b>		12	

**MICROBAN**



**Note:** Microban is available on the following finishes: 4, 15, 514

UPTOWN GD 1471 - ROUND		Finish Availability	GD 1471 Single Cylinder
	15	Satin Nickel	MTO
	26	Polished Chrome	MTO
	26D	Satin Chrome	MTO
	514	Matte black	MTO
	<b>List Price</b>		\$109
<b>Case Quantity</b>		12	

**MICROBAN**



**Note:** Microban is available on the following finishes: 15, 514

MIDTOWN GD 1471		Finish Availability	GD 1471 Single Cylinder
	15	Satin Nickel	9GD14710-035
	26	Polished Chrome	9GD14710-037
	26D	Satin Chrome	9GD14710-038
	514	Matte Black	9GD14710-036
	<b>List Price</b>		\$109
<b>Case Quantity</b>		12	

**MICROBAN**



**Note:** Microban is available on the following finishes: 15, 514

GCD 9471/9371	Finish Availability	GCD 9471 Single Cylinder - Square Face Latch	GCD 9471 Single Cylinder - Drive-In Latch	
	15	Satin Nickel	9GCD94710-059	
	26D	Satin Chrome	9GCD94710-061	
	514	Matte Black	MTO	
	<b>List Price</b>		\$100	\$100
	<b>Case Quantity</b>		12	12



**MICROBAN**



**Note:** Microban is available on the following finishes: 15, 514

 SmartKey is standard on all Weiser keyed products

**MICROBAN** Product is Microban coated

  Optional P & T Cylinder Keyway

  Fire Ratings Available

MTO = Made To Order

Intro  
Electronics  
Box Pack  
Visual Pack  
Parts

GD 9471/9371	Finish Availability	GD 9471 Single Cylinder	GD 9371 Double Cylinder
	3BR Lifetime Brass	MTO	MTO
	11P Venetian Bronze		MTO
	15 Satin Nickel	9GD94710-095	MTO
	15A Antique Nickel	MTO	MTO
	26 Polished Chrome	MTO	MTO
	26D Satin Chrome	9GD94710-097	MTO
	514 Matte Black	9GD94710-099	MTO
	<b>List Price</b>	\$97	\$124
<b>Case Quantity</b>	12	12	

Note: Microban is available for GD 9471 on the following finishes: 11P, 15, 15A, 514



SSD 9471 - SQUARE	Finish Availability	SSD 9471 Single Cylinder - SQT	SSD 9471 Single Cylinder FD - SQT
	15 Satin Nickel	9SSD94710-024	9SSD94710-031
	26 Polished Chrome	9SSD94710-026	9SSD94710-033
	26D Satin Chrome	9SSD94710-028	
	514 Matte Black	9SSD94710-030	9SSD94710-032
	<b>List Price</b>	\$69	\$75.50
	<b>Case Quantity</b>	12	12

Note: Microban is available on the following finishes: 15, 514  
\*Please order 3HR UL as GCD9471 SQT



SSD 9471 - ROUND	Finish Availability	SSD 9471 Single Cylinder - RDT	SSD 9471 Single Cylinder FD - RDT
	15 Satin Nickel	9SSD94710-023	9SSD94710-034
	26 Polished Chrome	9SSD94710-025	9SSD94710-036
	26D Satin Chrome	9SSD94710-027	
	514 Matte Black	9SSD94710-029	9SSD94710-035
	<b>List Price</b>	\$69	\$75.50
	<b>Case Quantity</b>	12	12

Note: Microban is available on the following finishes: 15, 514  
\*Please order 3HR UL as GCD9471 RDT





GCD 9571		Finish Availability	GCD 9571 Single Cylinder	GCD 9571 UL Single Cylinder 3HR UL
	15	Satin Nickel	MTO	MTO
	26	Polished Chrome	MTO	MTO
	26D	Satin Chrome	MTO	MTO
	514	Matte Black	MTO	MTO
	<b>List Price</b>			\$101
<b>Case Quantity</b>			12	12

\*Cylinder cap removed to show both cylinders

Note: Microban is available on the following finishes: 15, 514



GCD 9571 SQT		Finish Availability	GCD 9571 SQT Single Cylinder	GCD 9571 SQT UL Single Cylinder 3HR UL
	15	Satin Nickel	MTO	MTO
	26	Polished Chrome	MTO	MTO
	26D	Satin Chrome	MTO	MTO
	514	Matte Black	MTO	MTO
	<b>List Price</b>			\$101
<b>Case Quantity</b>			4	4

\*Cylinder cap removed to show both cylinders

Note: Microban is available on the following finishes: 15, 514



ROUND POCKET DOORLOCK		Finish Availability	WR1030 Passage	WR1031 Privacy
	11P	Venetian Bronze	9WR10300-020	9WR10310-020
	15	Satin Nickel	9WR10300-016	9WR10310-016
	26	Polished Chrome	9WR10300-019	9WR10310-019
	26D	Satin Chrome	9WR10300-018	9WR10310-018
	514	Matte Black	9WR10300-021	9WR10310-021
	<b>List Price</b>			\$41
<b>Case Quantity</b>			12	12

SQUARE POCKET DOORLOCK		Finish Availability	W1030 Passage	W1031 Privacy	
	15	Satin Nickel	9W10300-002	9W10310-009	
	<b>List Price</b>			\$41	\$45
	<b>Case Quantity</b>			18	18

SmartKey is standard on all Weiser keyed products

MICROBAN Product is Microban coated

KW WS Optional P & T Cylinder Keyway

UL Fire Ratings Available

MTO = Made To Order

**UPCHARGE INFORMATION**

<b>UL UPCHARGE</b>	<b>MODEL/FUNCTION</b>	<b>DESCRIPTION</b>	
ADD \$20	101UL Hall/Closet	3 Hour Fixed Faceplate	Must Specify Backset*
ADD \$20	9471/9371 Deadbolt	3 Hour Fixed Faceplate	Adjustable Backset
ADD \$6.50	101FD Hall/Closet	20 Minute Square, Radius or Drive-In	Adjustable Backset
ADD \$6.50	531/535 FD Keyed Entry	20 Minute Square, Radius or Drive-In	Adjustable Backset
ADD \$6.50	1471/9471/9371 FD Deadbolt	20 Minute Square, Radius or Drive-In	Adjustable Backset
ADD \$6	4 7/8" (124 mm)	ASA Strike	

**NOTE:** \*2-3/4" Standard, 2-3/8" Optional

<b>UPCHARGE</b>	<b>KEYING &amp; STAMPING CHARGES</b>
	Master Keying - \$3.50
	Grand Master Keying - \$7.00
	Project Keying - \$10.00
	Construction Keying - \$5.25
	Keying Alike - N/C
	Stamping - Per Key/Cylinder - N/C
	Stamping - Do Not Copy/Duplicate - N/C

Intro  
Electronics  
Box Pack  
Visual Pack  
Parts

All Weiser product meets ASTM E 331 water penetration testing

HANDLESETS	
<b>Door Prep</b>	Deadbolt: Cross Bore 2-1/8" or 1-1/2" Edge Bore 1" Latch Face 1" x 2-1/4". Handle: Cross Bore 2-1/8" Edge Bore 1" Latch Face 1" x 2-1/4"
<b>Backset</b>	Deadbolt: Adjustable to 2-3/8" or 2-3/4" Handle: Adjustable to 2-3/8" or 2-3/4"
<b>Door Thickness</b>	1-3/4" doors standard. 2-1/4" doors optional Not designed for use on 1-3/8" doors
<b>Cylinder</b>	SmartKey standard, see specific product for more WS and KW availability
<b>Faceplate</b>	1" x 2-1/4". Round corner, square corner and drive-in available in box
<b>Strikes</b>	Deadbolt: Cross Bore 1-1/8" x 2-3/4" Round or square radius standard in box Handle: 2-1/4" full lip Round or square radius standard in box Other options available
<b>Bolt</b>	Deadbolt: 1" steel Handle: 1/2" throw. Nickel plated.
<b>Door Handling</b>	Specify handling on all curved levers. Reversible on all straight levers
<b>ANSI/BHMA</b>	A156.5 Grade 1 (for deadbolt)
<b>ADA</b>	N/A
<b>UL</b>	*Meets 20 minute with Square, Radius or drive-in used

KNOBS	
<b>Door Prep</b>	Cross Bore 2-1/8" Edge Bore 1" Latch Face 1" x 2-1/4".
<b>Backset</b>	Adjustable to 2-3/8" or 2-3/4" UL 2-3/4" standard 2-3/8" optional
<b>Door Thickness</b>	1-3/8" - 1-3/4" doors standard. 2-1/4" doors optional
<b>Cylinder</b>	SmartKey standard, see specific product for more WS and KW availability
<b>Faceplate</b>	1" x 2-1/4". Round corner, square corner and drive-in available in box
<b>Strikes</b>	2-1/4" full lip. Other options available
<b>Bolt</b>	1/2" throw. Nickel plated
<b>Door Handling</b>	Reversible for right or left-handed doors
<b>ANSI/BHMA</b>	A156.2 Grade 2
<b>ADA</b>	N/A
<b>UL</b>	Fire rating, see specific product for availability

LEVERS	
<b>Door Prep</b>	Cross Bore 2-1/8" Edge Bore 1" Latch Face 1" x 2-1/4".
<b>Backset</b>	Adjustable to 2-3/8" or 2-3/4"
<b>Door Thickness</b>	1-3/8" - 1-3/4" doors standard. 2-1/4" doors optional
<b>Cylinder</b>	SmartKey standard, see specific product for more WS and KW availability
<b>Faceplate</b>	1" x 2-1/4". Round corner, square corner and drive-in available in box
<b>Strikes</b>	2-1/4" full lip. Other options available
<b>Bolt</b>	1/2" throw. Nickel plated
<b>Door Handling</b>	Specify handing only with Inactive levers
<b>ANSI/BHMA</b>	A156.2 Grade 2
<b>ADA</b>	Functions GLA 101, GLA 12 satisfies section 4.13.9 ADA requirement.
<b>UL</b>	Fire rating, see specific product for availability

DEADBOLTS - GCD 9471, GD 1471	
<b>Door Prep</b>	Cross Bore 2-1/8" Edge Bore 1" Latch Face 1" x 2-1/4".
<b>Backset</b>	Adjustable to 2-3/8" or 2-3/4"
<b>Door Thickness</b>	SMT 1-3/8" - 1-3/4" KW P&T 1-3/4"
<b>Cylinder</b>	SmartKey standard, see specific product for more WS and KW availability
<b>Faceplate</b>	1" x 2-1/4". Round corner, square corner and drive-in available in box
<b>Strikes</b>	Standard: Grade 1, 1-1/8" x 2-3/4" Other options available
<b>Bolt</b>	1" throw. Steel.
<b>Door Handling</b>	Reversible for right or left-handed doors
<b>ANSI/BHMA</b>	A156.5 Grade 1
<b>ADA</b>	Interior turn piece meets 4.13.9 ADA requirements
<b>UL</b>	Fire rating, see specific product for availability

## SPECIFICATIONS

## KEY CONTROL DEADBOLTS - GCD 9571

<b>Door Prep</b>	Cross Bore 2-1/8" Edge Bore 1" Latch Face 1" x 2-1/4".
<b>Door Thickness</b>	1-3/8" - 1-3/4"
<b>Cylinder</b>	2 SmartKey cylinders: 1 Standard SmartKey for users. 1 Secure new patented keyway for Key Control.
<b>Faceplate</b>	1" x 2-1/4"
<b>Strikes</b>	1-1/8" x 2-3/4"
<b>Bolt</b>	1" throw
<b>ANSI/BHMA</b>	A156.5 Grade 2
<b>ADA</b>	Interior turn piece meets 4.13.9 ADA requirements
<b>UL</b>	*Meets 3 hour fire rating for all UL functions when fronted latches used. Meets 20 minute with Square, Radius or Drive-In used. UL Ref# R10923

## DEADBOLTS - GD 9471, SSD 9471

<b>Door Prep</b>	Cross Bore 2-1/8" or 1-1/2" Edge Bore 1" Latch Face 1" x 2-1/4".
<b>Backset</b>	Adjustable to 2-3/8" or 2-3/4"
<b>Door Thickness</b>	1-3/8" - 1-3/4" doors standard 2-1/4" doors optional
<b>Cylinder</b>	SmartKey standard, see specific product for more WS and KW availability
<b>Faceplate</b>	1" x 2-1/4". Round corner, square corner and drive-in available in box
<b>Strikes</b>	1-1/8" x 2-3/4" Other options available
<b>Bolt</b>	1" throw. Steel.
<b>Door Handling</b>	Reversible for right or left-handed doors
<b>ANSI/BHMA</b>	A156.5 Grade 2
<b>ADA</b>	Interior turn piece meets 4.13.9 ADA requirements
<b>UL</b>	Fire rating, see specific product for availability

## POCKET DOOR LOCKS

<b>Door Prep</b>	2-1/8" Face Bore. 1" Edge Bore.
<b>Backset</b>	2-3/8"
<b>Door Thickness</b>	Adjustable for 1-3/8" or 1-3/4"
<b>Faceplate</b>	1" x 2-1/4" round corner. Steel. Accommodates flat and beveled doors.
<b>Strikes</b>	1-1/8" x 2-3/4" square corner with strike box and wood frame reinforcement. Steel. Privacy function only.
<b>Fasteners</b>	Standard flat or Phillips screws. #8 x 1/2" for latch, #8 x 1/2" for strike
<b>Door Handling</b>	Non-handed

**HANDLESETS**

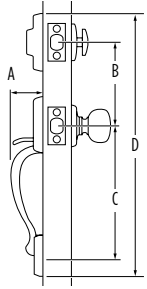

Design	A	B	C	D
Ashfield	2-21/32"	5-1/2"	8-13/32" through 9-11/16"	17-3/4"
Augusta	2-13/64"	5-1/2"	9-11/16"	17-45/64"
Avalon	2-21/32"	5-1/2"	8-13/32" through 9-11/16"	18-5/32"
Hawthorne	2-7/8"	5-1/2"	8-13/32"	17-9/16"
Prague	2-25/32"	5-1/2"	8-13/32" through 9-11/16"	17-23/32"

Design	A	B	C	D
Prescott	3-1/16"	5-1/2"	8-13/32" through 9-11/16"	17-13/16"
San Clemente	2-5/8"	5-1/2"	8-13/32" through 9-11/16"	17-29/32"
Tavaris	2-17/32"	5-1/2"	9-11/16"	18"
Vancouver	2-21/32"	5-1/2"	8-13/32" through 9-11/16"	17-29/32"

**LEVERS**

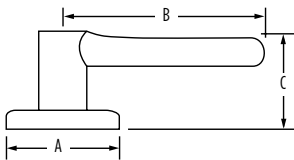

Design	A	B	C	C (Keyed)
Ashfield	2-5/8"	4-3/16"	2-9/16"	2-7/8"
Aspen	2-5/8"	4"	2-19/32"	
Avalon	2-5/8"	4-1/4"	2-1/2"	2-7/8"
Dane	2-5/8"	3-11/16"	2-1/2"	
Galiano	2-5/8"	4"	2-15/32"	
Halifax (Round Rose)	2-11/16"	4-1/4"	2-1/4"	2-9/16"
Halifax (Square Rose)	2-11/16"	4-1/4"	2-1/4"	2-9/16"
Lisbon (Round Rose)	2-11/16"	4-7/32"	2-1/4"	2-9/16"
Lisbon (Square Rose)	2-11/16"	4-7/32"	2-1/4"	2-9/16"
Katella	2-11/16"	4-1/4"	2-15/32"	
Katella (Keyed)	2-11/16"	4-1/4"	2-3/8"	2-9/16"

Design	A	B	C	C (Keyed)
Milan (Round Rose)	2-11/16"	4-5/32"	2-1/4"	2-9/16"
Milan (Square Rose)	2-11/16"	4-5/32"	2-1/4"	2-9/16"
Montreal (Round Rose)	2-11/16"	4-7/32"	2-1/4"	2-9/16"
Montreal (Square Rose)	2-11/16"	4-7/32"	2-1/4"	2-9/16"
Prague	2-11/16"	4-1/4"	2-1/2"	
Singapore (Round Rose)	2-11/16"	4-7/32"	2-9/16"	
Singapore (Square Rose)	2-11/16"	4-7/32"	2-9/16"	
Sydney (Round Rose)	2-11/16"	4-1/4"	2-1/4"	2-9/16"
Sydney (Square Rose)	2-11/16"	4-1/4"	2-1/4"	2-9/16"
Toluca	2-5/8"	4-7/32"	2-3/32"	

**KNOBS**

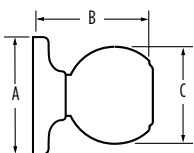

Design	A	B	C	C (Keyed)
Cambie	2-5/8"	2-13/32"	2-6/7"	
Hancock	2-5/8"	2-3/4"	2-3/8"	
Huntington	2-5/8"	2-15/16"	2-1/8"	
Phoenix	2-5/8"	2-7/16"	2-3/16"	
Prague	2-5/8"	2-7/16"	2-3/16"	2-11/16"
Troy	2-5/8"	2-5/16"	2-1/16"	
Wickham	2-13/16"	2-7/16"	2-3/8"	

**DEADBOLTS**

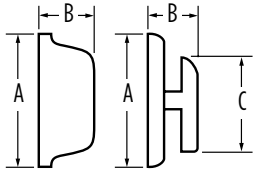

Design	A	B	C
GD 1471 Round Interior	2-5/8"	1-3/8"	1-21/32"
GD 1471 Round Exterior	2-5/8"	9/16"	N/A
GD 1471 Square Interior	2-5/8"	1-7/16"	1-21/32"
GD 1471 Square Exterior	2-5/8"	1/2"	N/A
GCD 9471 Interior	2-9/16"	1-5/32"	1-13/16"
GCD 9471 Exterior	2-5/8"	1-1/16"	
GCD 9571 Interior	2-9/16"	1-5/32"	1-13/16"
GCD 9571 Exterior	3"	1-5/8"	
GD 9471	2-9/16"	1-1/16"	1-3/4"
SSD 9471 Round Interior	2-17/32"	1-13/32"	1-11/16"
SSD 9471 Round Exterior	2-17/32"	15/16"	N/A
SSD 9471 Square Interior	2-17/32"	1-13/32"	1-11/16"
SSD 9471 Square Exterior	2-19/32"	15/16"	N/A

**POCKET DOORLOCKS**

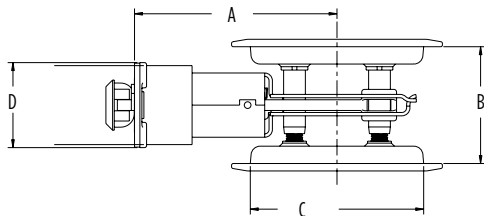

Design	A	B	C	D
Passage	2-3/8"	1-3/8" or 1-3/4"	2-1/8"	1"
Privacy	2-3/8"	1-3/8" or 1-3/4"	2-1/8"	1"

Intro

Electronics

Box Pack

Visual Pack

Parts



# ELEMENTS

box pack

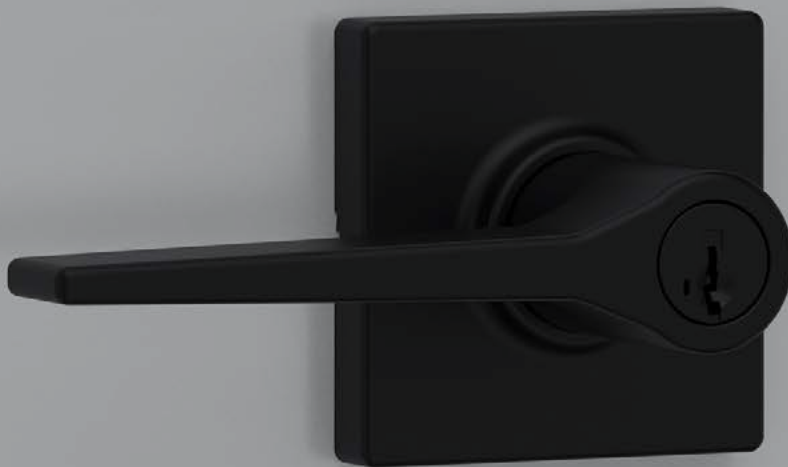

**ELEMENTS**

<b>HANDLESETS GROUP A</b>	<b>Function</b>	GAC 9771 Single Cylinder
	<b>List Price</b>	\$185

	<b>Finish Availability</b>		GAC9771 AMD
	15	Satin Nickel	9GAC97710-006
	26D	Satin Chrome	9GAC97710-007
	514	Matte Black	9GAC97710-009
	<b>Case Quantity</b>		6

**Note:** Microban is available on the following finishes: 15, 514

**MICROBAN**



20 min.

<b>HANDLESETS GROUP B</b>	<b>Function</b>	GAC 9771 Single Cylinder
	<b>List Price</b>	\$158

	<b>Finish Availability</b>		GAC9771 KNH
	11P	Venetian Bronze	MTO
	15	Satin Nickel	9GAC97710-002
	26D	Satin Chrome	9GAC97710-004
	<b>Case Quantity</b>		6

**Note:** Microban is available on the following finishes: 11P, 15

**MICROBAN**



20 min.

**NOTE:** All box pack handlesets are ordered LESS INTERIOR PACK (LIP). Interior packs must be ordered separately.

Intro  
Electronics  
Box Pack  
Visual Pack  
Parts



**ELEMENTS**

<b>Function</b>	GAC/GLC 9675 Single Cylinder
<b>List Price</b>	\$61

LEVERS	15	26	26D	514
Alfini	9GLC96750-030			
Breton Round	9GLC96750-050	9GLC96750-051		MTO
Breton Square	9GLC96750-046	9GLC96750-048	9GLC96750-049	9GLC96750-047
Hollis Round	9GLC96750-056	9GLC96750-057		MTO
Hollis Square	9GLC96750-052	9GLC96750-055	9GLC96750-054	9GLC96750-053
Kim	9GLC96750-032		9GLC96750-033	
Tristan Square - Left Handed	9GLC96750-042	MTO	MTO	9GLC96750-044
Tristan Square - Right Handed	9GLC96750-043	MTO	MTO	9GLC96750-045
<b>Case Quantity</b>	4	4	4	4

KNOBBS	15	26D
Beverly		MTO
Fairfax	9GAC96750-037	9GAC96750-038
<b>Case Quantity</b>	4	4

Intro

Electronics

Box Pack

Visual Pack

Parts

ELEMENTS

LEVERS GROUP A	Function	101 Hall/Closet	331 Bed/Bath	535 Keyed Entry	12 Inactive
	List Price	\$71	\$80	\$122	\$45

BRETON - SQUARE ROSE	Finish Availability	GLC 101 BRNL	GLC 331 BRNL	GLC 535 BRNL	GLC 12 BRNL
	15 Satin Nickel	9GLC1010-062	9GLC3310-062	9GLC5350-090	9GLC120-092
	26 Polished Chrome	9GLC1010-064	9GLC3310-064	9GLC5350-092	9GLC120-094
	26D Satin Chrome	9GLC1010-065	9GLC3310-065	9GLC5350-093	9GLC120-095
	514 Matte Black	9GLC1010-063	9GLC3310-063	9GLC5350-091	9GLC120-093
<b>Case Quantity</b>		12	12	6	12

Note: Microban is available on the following finishes: 15, 514



BRETON - ROUND ROSE	Finish Availability	GLC 101 BRNL	GLC 331 BRNL	GLC 535 BRNL	GLC 12 BRNL
	15 Satin Nickel	9GLC1010-066	9GLC3310-066	MTO	9GLC120-096
	26 Polished Chrome	9GLC1010-067	9GLC3310-067	MTO	9GLC120-097
	514 Matte Black	MTO	MTO	MTO	MTO
<b>Case Quantity</b>		12	12	6	12

Note: Microban is available on the following finishes: 15, 514



LEVERS GROUP B	Function	101 Hall/Closet	331 Bed/Bath	535 Keyed Entry	12 Inactive
	List Price	\$65	\$74	\$116	\$39

ALFINI	Finish Availability	GLC 101 AI	GLC 331 AI	GLC 535 AI	GLC 12 AI
	15 Satin Nickel	9GLC1010-048	9GLC3310-050	9GLC5350-082	9GLC120-071
	<b>Case Quantity</b>		12	12	12



KIM	Finish Availability	GLC 101 KML	GLC 331 KML	GLC 535 KML	GLC 12 KML
	15 Satin Nickel	9GLC1010-051	9GLC3310-053	9GLC5350-084	9GLC120-072
	26D Satin Chrome	9GLC1010-050	9GLC3310-052	9GLC5350-086	9GLC120-070
<b>Case Quantity</b>		12	12	12	6



Note: Microban is available on the following finishes: 15





Intro  
Electronics  
Box Pack  
Visual Pack  
Parts

**ELEMENTS**



LEVERS GROUP B	Function	101 Hall/Closet	331 Bed/Bath	535 Keyed Entry	12 Inactive LH	12 Inactive RH
	List Price	\$65	\$74	\$116	\$39	\$39

HOLLIS - SQUARE ROSE		Finish Availability	GLC 101 HSL	GLC 331 HSL	GLC 535 HSL	GLC 12 HSL
  	15	Satin Nickel	9GLC1010-075	9GLC3310-075	9GLC5350-101	9GLC120-105
	26	Polished Chrome	9GLC1010-078	9GLC3310-078	9GLC5350-104	9GLC120-108
	26D	Satin Chrome	9GLC1010-077	9GLC3310-077	9GLC5350-103	9GLC120-107
	514	Matte Black	9GLC1010-076	9GLC3310-076	9GLC5350-102	9GLC120-106
		<b>Case Quantity</b>	12	12	12	6

Note: Microban is available on the following finishes: 15, 514

HOLLIS - ROUND ROSE		Finish Availability	GLC 101 HSL	GLC 331 HSL	GLC 535 HSL	GLC 12 HSL
  	15	Satin Nickel	9GLC1010-079	9GLC3310-079	MTO	9GLC120-109
	26	Polished Chrome	9GLC1010-080	9GLC3310-080	MTO	9GLC120-110
	514	Matte Black	MTO	MTO	MTO	MTO
			<b>Case Quantity</b>	12	12	12

Note: Microban is available on the following finishes: 15, 514

TRISTAN - SQUARE ROSE		Finish Availability	GLC 101 TSL	GLC 331 TSL	GLC 535 TSL	GLC 12 TSL LH	GLC TSL RH
  	15	Satin Nickel	9GLC1010-060	9GLC3310-060	9GLC5350-088	9GLC120-088	9GLC120-089
	26	Polished Chrome	MTO	MTO	MTO	MTO*	MTO*
	26D	Satin Chrome	MTO	MTO	MTO	MTO*	MTO*
	514	Matte Black	9GLC1010-061	9GLC3310-061	9GLC5350-089	9GLC120-090	9GLC120-091
		<b>Case Quantity</b>	12	12	12	6	6

Note: Microban is available on the following finishes: 15, 514

\* Specify Right Hand (RH) or Left Hand (LH)

Intro

Electronics

Box Pack

Visual Pack

Parts

ELEMENTS

KNOBS GROUP A	Function	101 Hall/Closet	331 Bed/Bath	531 Keyed Entry	12 Inactive
	List Price		\$42	\$51	\$77

FAIRFAX	Finish Availability	GAC 101 F	GAC 331 F	GAC 531 F	GAC 12 F
	15 Satin Nickel	9GAC1010-042	9GAC3310-037	9GAC5310-078	9GAC120-033
	26D Satin Chrome	9GAC1010-039	9GAC3310-034	9GAC5310-075	9GAC120-030
Case Quantity		12	12	12	6

MICROBAN<sup>®</sup>



Note: Microban is available on the following finishes: 15

KNOBS GROUP B	Function	101 Hall/Closet	331 Bed/Bath	531 Keyed Entry	12 Inactive	581 Storeroom
	List Price		\$39	\$48	\$74	\$22

BEVERLY	Finish Availability	GAC 101 B	GAC 331 B	GAC 531 B	GAC 12 B	GAC 581 B
	26D Satin Chrome	MTO	MTO	MTO	MTO	MTO
	Case Quantity	12	12	12	6	12



	Function	101 Hall/Closet	301 Bed/Bath	501 Keyed Entry	581 Storeroom
	List Price		\$39	\$48	\$62

BEVERLY	Finish Availability	GAC 101 B	GAC 301 B	GAC 501 B	GAC 581 B
	9 / 32D Bright Bronze/ Satin Chrome	9GAC1010-045	9GAC3010-006	9GAC5010-011	9GAC5810-005
	Case Quantity	12	12	12	12

WS

NOTE: 9/32D uses a square spindle  
9/32D uses the legacy Weiser pin & tumbler only

Intro  
Electronics  
Box Pack  
Visual Pack  
Parts

**ELEMENTS**

GDC 9471	Finish Availability	GDC 9471 Single Cylinder
	15	Satin Nickel 9GDC94710-068
	26D	Satin Chrome 9GDC94710-070
	514	Matte Black MTO
	<b>List Price</b> \$54	
	<b>Case Quantity</b> 12	

**MICROBAN**



**Note:** Microban is available on the following finishes: 15, 514

GDC 9471 SQT	Finish Availability	GDC 9471 SQT Single Cylinder
	15	Satin Nickel 9GDC94710-069
	26	Polished Chrome MTO
	26D	Satin Chrome 9GDC94710-071
	514	Matte Black 9GDC94710-072
	<b>List Price</b> \$59	
<b>Case Quantity</b> 12		

**MICROBAN**



**Note:** Microban is available on the following finishes: 15, 514

GDC 9471 RDT	Finish Availability	GDC 9471 RDT Single Cylinder
	15	Satin Nickel 9GDC94710-076
	26	Polished Chrome 9GDC94710-077
	514	Matte Black MTO
	<b>List Price</b> \$60	
	<b>Case Quantity</b> 12	

**MICROBAN**



**Note:** Microban is available on the following finishes: 15, 514

Intro

Electronics



Box Pack

Visual Pack

Parts

 SmartKey is standard on all Weiser keyed products

**MICROBAN** Product is Microban coated

  Optional P & T Cylinder Keyway

 Fire Ratings Available

MTO = Made To Order

**UPCHARGE INFORMATION**

**ELEMENTS**

UL UPCHARGE	MODEL/FUNCTION	DESCRIPTION	
ADD \$6.50	101FD Hall/Closet	20 Minute Square, Radius or Drive-In	Adjustable Backset
ADD \$6.50	531/535 FD Keyed Entry	20 Minute Square, Radius or Drive-In	Adjustable Backset
ADD \$6.50	9471 FD Deadbolt	20 Minute Square, Radius or Drive-In	Adjustable Backset
ADD \$6	4 7/8" (124 mm)	ASA Strike	

**NOTE:** \*2-3/4" Standard, 2-3/8" Optional

UPCHARGE	KEYING & RESTAMPING CHARGES
	Master Keying - \$3.50
	Grand Master Keying - \$7.00
	Project Keying - \$10.00
	Construction Keying - \$5.25
	Keying Alike - N/C
	Stamping - Per Key/Cylinder - N/C
	Stamping - Do Not Copy/Duplicate - N/C

Intro  
Electronics  
Box Pack  
Visual Pack  
Parts

**ELEMENTS**

All Elements product meets ASTM E 331 water penetration testing

**HANDLESETS**

<b>Door Prep</b>	Deadbolt: Cross Bore 2-1/8" or 1-1/2" Edge Bore 1" Latch Face 1" x 2-1/4". Handle: Cross Bore 2-1/8" Edge Bore 1" Latch Face 1" x 2-1/4"
<b>Backset</b>	Deadbolt: Adjustable to 2-3/8" or 2-3/4" Handle: Adjustable to 2-3/8" or 2-3/4"
<b>Door Thickness</b>	1-3/4" doors standard. 2-1/4" doors optional Not designed for use on 1-3/8" doors
<b>Cylinder</b>	SmartKey standard, see specific product for more WS and KW availability
<b>Faceplate</b>	1" x 2-1/4". Round corner, square corner and drive-in available in box

<b>Strikes</b>	Deadbolt: 1-1/8" x 2-3/4" Round or square radius standard in box Handle: 2-1/4" full lip Round or square radius standard in box Other options available
----------------	---------------------------------------------------------------------------------------------------------------------------------------------------------------------

<b>Bolt</b>	Deadbolt: 1" Handle: 1/2" throw
-------------	------------------------------------

<b>Door Handling</b>	Reversible for right or left-handed doors
----------------------	-------------------------------------------

<b>ANSI/BHMA</b>	A156.5 Grade 3 (for deadbolt)
------------------	-------------------------------

<b>ADA</b>	N/A
------------	-----

<b>UL</b>	Fire rating, see specific product for availability
-----------	----------------------------------------------------

**LEVERS**

<b>Door Prep</b>	Cross Bore 2-1/8" Edge Bore 1" Latch Face 1" x 2-1/4".
<b>Backset</b>	Adjustable to 2-3/8" or 2-3/4" UL 2-3/4" standard 2-3/8" optional
<b>Door Thickness</b>	1-3/8" - 1-3/4" doors standard. 2-1/4" doors optional on GLC 101 models
<b>Cylinder</b>	SmartKey standard, see specific product for more WS and KW availability
<b>Faceplate</b>	1" x 2-1/4". Round corner, square corner and drive-in available in box

<b>Strikes</b>	2-1/4" full lip. Other options available
----------------	------------------------------------------

<b>Bolt</b>	1/2" throw. Nickel plated
-------------	---------------------------

<b>Door Handling</b>	Reversible for right or left-handed doors
----------------------	-------------------------------------------

<b>ANSI/BHMA</b>	A156.2 Grade 3
------------------	----------------

<b>ADA</b>	Functions GLC 101 and GLC 12 satisfy section 4.13.9. ADA requirement
------------	----------------------------------------------------------------------

<b>UL</b>	Fire rating, see specific product for availability
-----------	----------------------------------------------------

**KNOBS**

<b>Door Prep</b>	Cross Bore 2-1/8" Edge Bore 1" Latch Face 1" x 2-1/4".
<b>Backset</b>	Adjustable to 2-3/8" or 2-3/4" UL 2-3/4" standard 2-3/8" optional
<b>Door Thickness</b>	1-3/8" - 1-3/4" doors standard. 2-1/4" doors optional. 2-1/4" doors optional on GAC 101 models only
<b>Cylinder</b>	SmartKey standard, see specific product for more WS and KW availability
<b>Faceplate</b>	1" x 2-1/4". Round corner, square corner and drive-in available in box

<b>Strikes</b>	2-1/4" full lip. Other options available.
----------------	-------------------------------------------

<b>Bolt</b>	1/2" throw. Nickel plated
-------------	---------------------------

<b>Door Handling</b>	Reversible for right or left-handed doors
----------------------	-------------------------------------------

<b>ANSI/BHMA</b>	A156.2 Grade 3
------------------	----------------

<b>ADA</b>	N/A
------------	-----

<b>UL</b>	Fire rating, see specific product for availability
-----------	----------------------------------------------------

**DEADBOLTS**

<b>Door Prep</b>	Cross Bore 2-1/8" Edge Bore 1" Latch Face 1" x 2-1/4".
<b>Backset</b>	Adjustable to 2-3/8" or 2-3/4"
<b>Door Thickness</b>	1-3/8" - 1-3/4" doors standard
<b>Cylinder</b>	SmartKey standard, see specific product for more WS and KW availability
<b>Faceplate</b>	1" x 2-1/4". Round corner, square corner and drive-in available in box

<b>Strikes</b>	1-1/8" x 2-3/4"
----------------	-----------------

<b>Bolt</b>	1" throw
-------------	----------

<b>Door Handling</b>	Reversible for right or left-handed doors
----------------------	-------------------------------------------

<b>ANSI/BHMA</b>	A156.5 Grade 3
------------------	----------------

<b>ADA</b>	Interior turn piece meets 4.13.9 ADA requirements
------------	---------------------------------------------------

<b>UL</b>	Fire rating, see specific product for availability
-----------	----------------------------------------------------

**ELEMENTS**

**HANDLESETS**

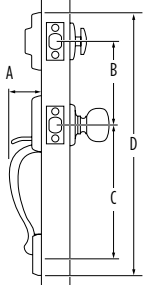

Design	A	B	C	D
Amador	2-3/32"	5-1/2"	9-11/32"	17-15/32"
Brentwood	2-1/32"	5-1/2"	8-13/32"	18-1/16"
Kingsway	2-7/32"	5-1/2"	8-13/32"	17-7/16"

**LEVERS**

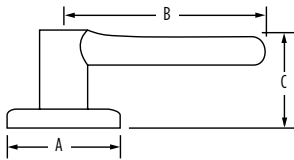

Design	A	B	C	C (Keyed)
Alfina	2-5/8"	3-3/4"	2-1/4"	2-5/8"
Belmont	2-5/8"	3-3/4"	2-1/4"	2-5/8"
Breton Square	2-5/8"	4"	2-7/16"	
Breton Round	2-5/8"	4"	2-7/16"	
Hollis Square	2-5/8"	4-4/32"	2-12/32"	
Hollis Round	2-5/8"	4-4/32"	2-12/32"	
Kim	2-5/8"	3-5/8"	1-15/16"	2-5/8"
Tristan	2-5/8"	4-7/16"	1-7/8"	2-7/16"

**KNOBS**

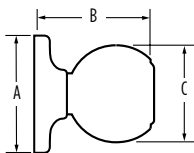

Design	A	B	C
Beverly	2-19/32"	2-7/16"	2"
Fairfax	2-5/8"	2-11/32"	1-15/16"
Yukon	2-5/8"	2-23/32"	1-7/8"

**DEADBOLTS**

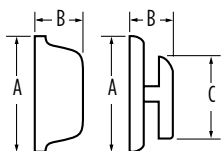

Design	A	B	C
GDC 9471	2-1/2"	1-1/8"	1-3/4"
GDC 9471 Square	2-1/2"	1-1/8"	1-3/4"
GDC 9471 Round	2-1/2"	1-1/8"	1-3/4"





**SAFE LOCK**

box pack

Intro



Electronics



Box Pack

Visual Pack



Parts

DAYLON	Function	Hall/Closet 4L Latch	Bed/Bath 4L Latch	Inactive	3HR UL Hall Closet
	List Price	\$53	\$59	\$33	\$73

DAYLON	Finish Availability	SL1000DAL	SL3000DAL	SL7000DAL	SL1002DAL
 	15 Satin Nickel	9SL10000-077	9SL30000-074	9SL70000-052	MTO
	26 Polished Chrome	9SL10000-078	9SL30000-075	9SL70000-053	MTO
	26D Satin Chrome	9SL10000-079	9SL30000-076	9SL70000-054	MTO
	514 Matte Black	9SL10000-081	9SL30000-078	9SL70000-056	MTO
	<b>Case Quantity</b>		20	20	20



 	15 Satin Nickel	9SL10000-082	9SL30000-079	9SL70000-057	MTO
	26 Polished Chrome	9SL10000-083	9SL30000-080	9SL70000-058	MTO
	26D Satin Chrome	MTO	MTO	MTO	MTO
	514 Matte Black	9SL10000-084	9SL30000-081	9SL70000-059	MTO
	<b>Case Quantity</b>		20	20	20

GRAPEVINE GROUP A	Function	Hall/Closet - Square Faced Latch	Hall/Closet - Drive-in Latch	Bed/Bath - Square Faced Latch	Bed/Bath - Drive-in Latch	Inactive	3HR UL Hall/Closet
	List Price	\$46	\$46	\$53	\$53	\$25	\$66





GRAPEVINE	Finish Availability	SL1000GV	SL1000GV	SL3000GV	SL3000GV	SL7000GV	SL1002GV
 	15 Satin Nickel	9SL10000-051	9SL10000-070	9SL30000-051	9SL30000-069	9SL70000-039	MTO
	<b>Case Quantity</b>		20	20	20	20	20



WINSTON GROUP A	Function	Hall/Closet - Square Faced Latch	Hall/Closet - Drive-in Latch	Bed/Bath - Square Faced Latch	Bed/Bath - Drive-in Latch	Keyed Entry - Square Faced Latch	Keyed Entry - Drive-in Latch	Inactive	3HR UL Hall/Closet
	List Price	\$45	\$45	\$51	\$51	\$66	\$66	\$24	\$65

WINSTON	Finish Availability	SL1000WI	SL1000WI	SL3000WI	SL3000WI	SL5000WI	SL5000WI	SL7000WI	SL1002WI
	11P Venetian Bronze	MTO	MTO	MTO	MTO	MTO	MTO	MTO	MTO
	15 Satin Nickel	9SL10000-058	9SL10000-057	9SL30000-057	9SL30000-056	9SL50000-097	9SL50000-096	9SL70000-043	MTO
   20 min. 3 Hour	Case Quantity	20	20	20	20	20	20	20	20

WINSTON GROUP B	Function	Hall/Closet - Square Faced Latch	Hall/Closet - Drive-in Latch	Bed/Bath - Square Faced Latch	Bed/Bath - Drive-in Latch	Keyed Entry - Square Faced Latch	Keyed Entry - Drive-in Latch	Inactive	3HR UL Hall/Closet
	List Price	\$42	\$42	\$48	\$48	\$63	\$63	\$21	\$62

WINSTON	Finish Availability	SL1000WI	SL1000WI	SL3000WI	SL3000WI	SL5000WI	SL5000WI	SL7000WI	SL1002WI
	26D Satin Chrome	9SL10000-061	9SL10000-060	9SL30000-060	9SL30000-059	9SL50000-100	9SL50000-099	9SL70000-044	MTO
	   20 min. 3 Hour	Case Quantity	20	20	20	20	20	20	20

Intro

Electronics

Box Pack

Visual Pack

Parts

Intro

Electronics

Box Pack

Visual Pack

Parts

LAYTON	Function	Hall/Closet - Square Faced Latch	Hall/Closet - Drive-in Latch	Bed/Bath - Square Faced Latch	Bed/Bath - Drive-in Latch	Inactive LH	Inactive RH	3HR UL Hall/Closet
	List Price	\$46	\$46	\$52	\$52	\$26	\$26	\$66

LAYTON	Finish Availability	SL1000LY	SL1000LY	SL3000LY	SL3000LY	SL7000LY	SL7000LY	SL1002LY
--------	---------------------	----------	----------	----------	----------	----------	----------	----------



15	Satin Nickel	9SL10000-045	9SL10000-044	9SL30000-045	9SL30000-044	9SL70000-033	9SL70000-034	MTO
26D	Satin Chrome	MTO	MTO	MTO	MTO	MTO	MTO	MTO
<b>Case Quantity</b>		20	20	20	20	20	20	20



WESTLEY	Function	Hall/Closet - Square Faced Latch	Hall/Closet - Drive-in Latch	Bed/Bath - Square Faced Latch	Bed/Bath - Drive-in Latch	Inactive	3HR UL Hall/Closet
	List Price	\$53	\$53	\$59	\$59	\$32	\$73

WESTLEY	Finish Availability	SL1000WTL	SL1000WTL	SL3000WTL	SL3000WTL	SL7000WTL	SL1002WTL
---------	---------------------	-----------	-----------	-----------	-----------	-----------	-----------



15	Satin Nickel	9SL10000-066	9SL10000-065	9SL30000-065	9SL30000-064	9SL70000-047	MTO
26	Polished Chrome	MTO	9SL10000-076	MTO	9SL30000-073	9SL70000-051	MTO
26D	Satin Chrome	MTO	9SL10000-067	MTO	9SL30000-066	9SL70000-048	MTO
<b>Case Quantity</b>		20	20	20	20	20	20



REGINA GROUP A	Function	Hall/Closet - Square Faced Latch	Hall/Closet - Drive-in Latch	Bed/Bath - Square Faced Latch	Bed/Bath - Drive-in Latch	Keyed Entry - Square Faced Latch	Keyed Entry - Drive-in Latch	Inactive	3HR UL Hall/Closet	3HR UL Keyed Entry
	List Price	\$27	\$27	\$30	\$30	\$42	\$42	\$17	\$47	\$62

REGINA	Finish Availability	SK1000RG	SK1000RG	SK3000RG	SK3000RG	SK5000RG	SK5000RG	SK7000RG	SK1002RG	SK5002RG
	15 Satin Nickel	9SK10000-040	9SK10000-039	9SK30000-040	9SK30000-039	9SK50000-057	9SK50000-056	9SK70000-022	MTO	MTO
	<b>Case Quantity</b>	30	30	30	30	30	30	30	30	30



REGINA GROUP B	Function	Hall/Closet - Square Faced Latch	Hall/Closet - Drive-in Latch	Bed/Bath - Square Faced Latch	Bed/Bath - Drive-in Latch	Keyed Entry - Square Faced Latch	Keyed Entry - Drive-in Latch	Inactive	3HR UL Hall/Closet	3HR UL Keyed Entry
	List Price	\$24	\$24	\$27	\$27	\$40	\$40	\$14	\$44	\$60

REGINA	Finish Availability	SK1000RG	SK1000RG	SK3000RG	SK3000RG	SK5000RG	SK5000RG	SK7000RG	SK1002RG	SK5002RG
	26D Satin Chrome	9SK10000-044	9SK10000-043	9SK30000-044	9SK30000-043	9SK50000-061	9SK50000-060	9SK70000-024	MTO	MTO
	<b>Case Quantity</b>	30	30	30	30	30	30	30	30	30



Intro

Electronics

Box Pack

Visual Pack

Parts

Intro  
Electronics  
Box Pack  
Visual Pack  
Parts

DEADBOLTS GROUP A	Function	Single Cylinder - Square Faced Latch	Single Cylinder - Drive-in Latch	3HR UL Single Cylinder
	List Price	\$32	\$32	\$52

9100	Finish Availability	SD9100	SD9100	SD9102
	15 Satin Nickel	MTO	MTO	MTO
	<b>Case Quantity</b>	12	12	12



DEADBOLTS GROUP B	Function	Single Cylinder - Square Faced Latch	Single Cylinder - Drive-in Latch	3HR UL Single Cylinder
	List Price	\$30	\$30	\$50

9100	Finish Availability	SD9100	SD9100	SD9102
	26D Satin Chrome	MTO	MTO	MTO
	<b>Case Quantity</b>	12	12	12



UL UPCHARGE	MODEL/FUNCTION	DESCRIPTION	
ADD \$6.50	101FD Hall/Closet	20 Minute Square, Radius or Drive-In	Adjustable Backset
ADD \$6.50	531/535 FD Keyed Entry	20 Minute Square, Radius or Drive-In	Adjustable Backset
ADD \$6.50	1471/9471/9371 FD Deadbolt	20 Minute Square, Radius or Drive-In	Adjustable Backset
ADD \$6	4 7/8" (124 mm)	ASA Strike	

## HANDLESETS

<b>Door Prep</b>	Deadbolt: Cross Bore 2-1/8" or 1-1/2" Edge Bore 1" Latch Face 1" x 2-1/4"	<b>Strikes</b>	Deadbolt: 1" x 2-1/4" Specify round corner, square corner or full lip (5303) Handle: 2-1/4" full lip Specify round corner or square corner
<b>Backset</b>	Deadbolt: Adjustable to 2-3/8" or 2-3/4" Handle: Adjustable to 2-3/8" or 2-3/4"	<b>Bolt</b>	Deadbolt: 1" throw Handle: 1/2" throw
<b>Door Thickness</b>	1-3/8" - 1-3/4" doors standard No thick door option	<b>Door Handling</b>	Non-handed
<b>Cylinder</b>	KW 5 pin	<b>ANSI/BHMA</b>	A156.5 Grade 3 Deadbolt
<b>Faceplate</b>	1" x 2-1/4" Specify round corner, square corner or drive-in	<b>ADA</b>	N/A
		<b>UL</b>	N/A

## KNOBS

<b>Door Prep</b>	Cross Bore 2-1/8" Edge Bore 1" Latch Face 1" x 2-1/4"	<b>Strikes</b>	2-1/4" full lip. Specify round corner or square corner.
<b>Backset</b>	Adjustable to 2-3/8" or 2-3/4"	<b>Bolt</b>	1/2" throw
<b>Door Thickness</b>	1-3/8" - 1-3/4" doors standard No thick door option	<b>Door Handling</b>	Non-handed
<b>Cylinder</b>	KW 5 pin	<b>ANSI/BHMA</b>	A156.2 Grade 3
<b>Faceplate</b>	1" x 2-1/4" Specify round corner, square corner or drive-in	<b>ADA</b>	N/A
		<b>UL</b>	Meets UL 3 hour fire rating for all UL functions ULRef # R7860

## LEVERS

<b>Door prep</b>	Cross Bore 2-1/8" Edge Bore 1" Latch Face 1" x 2-1/4".	<b>Strikes</b>	2-1/4" full lip. Specify round corner or square corner
<b>Backset</b>	Adjustable to 2-3/8" or 2-3/4" UL 2-3/4" standard 2-3/8" optional	<b>Bolt</b>	1/2" throw
<b>Door Thickness</b>	1-3/8" - 1-3/4" doors standard. No thick door option	<b>ANSI/BHMA</b>	A156.2 Grade 3
<b>Cylinder</b>	KW 5 pin	<b>ADA</b>	1000 and 7000 functions satisfy section 4.13.9 ADA requirements
<b>Faceplate</b>	1" x 2-1/4" Specify round corner, square corner or drive-in	<b>UL</b>	Meets UL 3 hour fire rating for all UL functions. ULRef # R7860. Meets 20-minute with drive-in latch

## DEADBOLTS

<b>Door Prep</b>	Single & Double Cylinder: Cross Bore 2-1/8". Edge Bore 1" Latch Face 1" x 2-1/4" One Sided Deadbolt: Half Cross Bore 1-5/8" Edge Bore 1" Latch Face 1" x 2-1/4"	<b>Strikes</b>	1" x 2-1/4" Specify round corner or square corner
<b>Backset</b>	Adjustable to 2-3/8" or 2-3/4"	<b>Bolt</b>	1" throw.
<b>Door Thickness</b>	1-3/8" - 1-3/4" doors standard. No thick door option	<b>Door Handling</b>	Non-handed
<b>Cylinder</b>	KW 5 pin	<b>ANSI/BHMA</b>	A156.5 Grade 3
<b>Faceplate</b>	1" x 2-1/4" Specify round corner, square corner or drive-in	<b>ADA</b>	Interior turn piece meets 4.13.9 ADA requirements
		<b>UL</b>	Meets UL 3 hour fire rating for all UL functions. ULRef # 10923



**LEVERS**

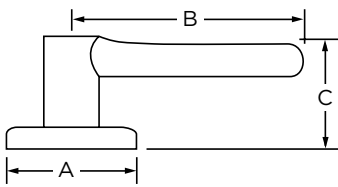

Design	A	B	C	C (Keyed)
Daylon	2-9/16"	4-3/32"	2-5/16"	
Grapevine	2-9/16"	3-3/4"	2-1/2"	2-1/2"
Layton	2-9/16"	3-5/8"	2-3/8"	2-3/8"
Westley	2-9/16"	4-3/32"	2-5/16"	
Winston	2-9/16"	3-5/8"	2-3/8"	2-3/8"

**KNOBS**

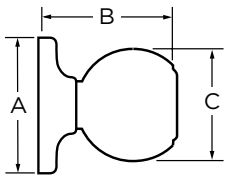

Design	A	B	C
Regina	2-9/16"	2-7/8"	1-3/4"

**DEADBOLTS**

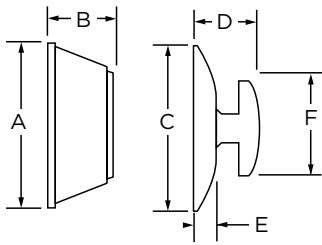

Design	A	B	C	D	E	F
Single Cylinder	2-1/2"	1-1/8"	2-9/16"	3/4"	1/4"	2-1/8"





# VISUAL PACK



Intro

Electronics

Box Pack

Visual Pack

Parts

HANDLESETS GROUP A	Function	9471 / 8471 Single Cylinder	8471 Single Cylinder
	List Price	\$450	\$450

SAN CLEMENTE	Finish Availability		GLA8471 SCE/HFL	GA8471 SCE/CBK
	15	Satin Nickel	9GLA84710-001	9GA84710-001
	514	Matte Black	9GLA84710-002	9GA84710-002
				
		Interior	Halifax	Cambie
		<b>Case Quantity</b>	2	2





VANCOUVER	Finish Availability		GLA8471 VNH/HFL
	15	Satin Nickel	9GLA84710-004
	514	Matte Black	9GLA84710-005
		Interior	Halifax
		<b>Case Quantity</b>	2





PRAGUE	Finish Availability		GLA8471 PGH/PGL
	15	Satin Nickel	9GLA84710-014
	514	Matte Black	9GLA84710-015
		Interior	Prague
		<b>Case Quantity</b>	2



<b>HANDLESETS GROUP B</b>	<b>Function</b>	9471 Single Cylinder
	<b>List Price</b>	\$443

<b>ASHFIELD</b> 	Finish Availability		GLA9471 ADH/ADL
	514	Matte Black	9GLA94710-025
			
	Interior		Ashfield
	<b>Case Quantity</b>		2



<b>AVALON</b> 	Finish Availability		GLA9471 AVH/AVL
	11P	Venetian Bronze	9GLA94710-026
	15	Satin Nickel	9GLA94710-027
			
	Interior		Avalon
<b>Case Quantity</b>		2	



<b>TAVARIS</b> 	Finish Availability		GLA9471 TVH/BRNL
	15	Satin Nickel	9GLA94710-039
	514	Matte Black	9GLA94710-038
			
	Interior		Breton
<b>Case Quantity</b>		2	



Intro



Electronics

Box Pack

Visual Pack

Parts

<b>HANDLESETS GROUP C</b>	<b>Function</b>	9471 Single Cylinder	9471 Single Cylinder
	<b>List Price</b>	\$407	\$407

<b>HAWTHORNE</b>	Finish Availability		GLA9471 HE/TC	GA9471 HE/T
	11P	Venetian Bronze		9GA94710-043
	15	Satin Nickel	9GLA94710-013	
				
	Interior		Toluca	Troy
	<b>Case Quantity</b>		2	2





<b>HERITAGE</b>	Finish Availability		GA9471 H/HT	GA9471 H/P
	3BR	Lifetime Brass	9GA94710-031	
	5	Antique Brass	9GA94710-034	
	15A	Antique Nickel		9GA94710-035
	Interior			
	<b>Case Quantity</b>		2	2

Intro  
Electronics  
Box Pack  
Visual Pack  
Parts

HANDLESETS GROUP C	Function	9471 Single Cylinder	9471 Single Cylinder
	List Price	\$407	\$407

AUGUSTA	Finish Availability	GA9471 A/P	GA9471 A/T
	15A Antique Nickel	9GA94710-012	
	514 Matte Black		9GA94710-020
			
	Interior	Phoenix	Troy
	<b>Case Quantity</b>	2	2



PRESCOTT	Finish Availability	GLA8471 PTH/TC	GLA8471 PTH/KAL
	11P Venetian Bronze	9GLA84710-006	9GLA84710-011
	15 Satin Nickel	9GLA84710-007	9GLA84710-009
	514 Matte Black	9GLA84710-008	9GLA84710-010
			
	Interior	Toluca	Katella
	<b>Case Quantity</b>	2	2



Intro

Electronics

Box Pack

**Visual Pack**

Parts

<b>HANDLESET MINUS</b>	<b>Function</b>	7771 Handleset Minus
	<b>List Price</b>	\$285

	<b>AVALON</b>		Finish Availability	GLA7771 AVH/AVL15
	15	Satin Nickel		9GLA77710-006
			Interior	Avalon
			<b>Case Quantity</b>	2



**MICROBAN**

	<b>HAWTHORNE</b>		Finish Availability	GLA7771 HE/TC11P
	11P	Venetian Bronze		9GLA77710-004
			Interior	Toluca
			<b>Case Quantity</b>	2



**MICROBAN**

	<b>SAN CLEMENTE</b>		Finish Availability	GLA7771 SCE/HFL
	15	Satin Nickel		9GLA77710-007
	514	Matte Black		9GLA77710-001
			Interior	Halifax
		<b>Case Quantity</b>	2	





**MICROBAN**



<b>HANDLESETS MINUS</b>	<b>Function</b>	7771 Handleset Minus
	<b>List Price</b>	\$285

<b>TAVARIS</b> 	<b>Finish Availability</b>		GLA7771 TVH/BRNL
	15	Satin Nickel	9GLA77710-009
			
	Interior		Breton
	<b>Case Quantity</b>		2



<b>PRESCOTT</b> 	<b>Finish Availability</b>		GLA7771 PTH/KAL
	15	Satin Nickel	9GLA77710-010
	514	Matte Black	9GLA77710-011
			
	Interior		Katella
<b>Case Quantity</b>		2	



Intro

LEVERS GROUP A	<b>Function</b>	101 Hall/Closet	331 Bed/Bath	535 Keyed Entry	12 Inactive LH	12 Inactive RH
	<b>List Price</b>	\$103	\$120	\$173	\$64	\$64

<b>ASHFIELD</b>	Finish Availability		GLA 101 ADL	GLA 331 ADL	GLA 535 ADL	GLA 12 ADL
	514	Matte Black	9GLA1010-060	9GLA3310-059	9GLA5350-089	9GLA120-048
	<b>Case Quantity</b>		4	4	4	4



Electronics

<b>AVALON</b>	Finish Availability		GLA 101 AVL	GLA 331 AVL	GLA 535 AVL	GLA 12 AVL LH	GLA 12 AVL RH
	15	Satin Nickel	9GLA1010-061	9GLA3310-060	9GLA5350-090	9GLA120-049	9GLA120-050
	<b>Case Quantity</b>		4	4	4	4	4



Box Pack

LEVERS GROUP B	<b>Function</b>	101 Hall/Closet	331 Bed/Bath	535 Keyed Entry	12 Inactive
	<b>List Price</b>	\$90	\$107	\$160	\$55

<b>ASPEN</b>	Finish Availability		GLA 101 A	GLA 331 A	GLA 535 A	GLA 12 A
	15	Satin Nickel	9GLA1010-041	9GLA3310-040	9GLA5350-050	9GLA120-027
	<b>Case Quantity</b>		4	4	4	4



Parts



<b>LEVERS GROUP C</b>	<b>Function</b>	101 Hall/Closet	331 Bed/Bath	535 Keyed Entry	12 Inactive
	<b>List Price</b>	\$83	\$100	\$156	\$51

<b>PRAGUE</b>	Finish Availability	GLA 101 PGL	GLA 331 PGL	GLA 535 PGL	GLA 12 PGL
 <b>MICROBAN</b>	15 Satin Nickel	9GLA1010-137	9GLA3310-136	9GLA5350-181	9GLA120-131
	514 Matte Black	9GLA1010-138	9GLA3310-137	9GLA5350-182	9GLA120-132
	<b>Case Quantity</b>	4	4	4	4

<b>HALIFAX</b>	Finish Availability	GLA 101 HFL	GLA 331 HFL	GLA535 HFL	GLA 12 HFL
 <b>MICROBAN</b>	4 Satin Brass	9GLA1010-151	9GLA3310-144	9GLA5350-185	9GLA120-137
	<b>Case Quantity</b>	4	4	4	4

<b>LEVERS GROUP D</b>	<b>Function</b>	101 Hall/Closet	331 Bed/Bath	535 Keyed Entry	12 Inactive
	<b>List Price</b>	\$79	\$96	\$149	\$48

<b>HALIFAX</b>	Finish Availability	GLA 101 HFL	GLA 331 HFL	GLA535 HFL	GLA 12 HFL
 <b>MICROBAN</b>	11P Venetian Bronze	9GLA1010-062	9GLA3310-061	9GLA5350-091	9GLA120-051
	15 Satin Nickel	9GLA1010-063	9GLA3310-062	9GLA5350-092	9GLA120-052
	26 Polished Chrome	9GLA1010-064	9GLA3310-063	9GLA5350-093	9GLA120-053
	514 Matte Black	9GLA1010-065	9GLA3310-064	9GLA5350-094	9GLA120-054
	<b>Case Quantity</b>	4	4	4	4

**Note:** Microban is available on the following finishes: 11P, 15, 514

<b>MILAN</b>	Finish Availability	GLA 101 MIL	GLA331 MIL	GLA 535 MIL	GLA 12 MIL
 <b>MICROBAN</b>	15 Satin Nickel	9GLA1010-066	9GLA3310-065	9GLA5350-095	9GLA120-055
	26D Satin Chrome	9GLA1010-067	9GLA3310-066	9GLA5350-096	9GLA120-056
	514 Matte Black	9GLA1010-126	9GLA3310-125	9GLA5350-170	9GLA120-120
	<b>Case Quantity</b>	4	4	4	4

**Note:** Microban is available on the following finishes: 15, 514

Intro

LEVERS GROUP D	Function	101 Hall/Closet	331 Bed/Bath	535 Keyed Entry	12 Inactive
	List Price	\$79	\$96	\$149	\$48

LISBON	Finish Availability	GLA 101 LSL	GLA 331 LSL	GLA 535 LSL	GLA 12 LSL
 <b>MICROBAN</b>	15 Satin Nickel	9GLA1010-129	9GLA3310-128	9GLA5350-173	9GLA120-123
	<b>Case Quantity</b>	4	4	4	4

Electronics

KATELLA	Finish Availability	GLA 101 KAL	GLA 331 KAL	GLA 535 KAL	GLA 12 KAL
 <b>MICROBAN</b>	11P Venetian Bronze	9GLA1010-134	9GLA3310-133	9GLA5350-178	9GLA120-128
	15 Satin Nickel	9GLA1010-132	9GLA3310-131	9GLA5350-176	9GLA120-126
	514 Matte Black	9GLA1010-133	9GLA3310-132	9GLA5350-177	9GLA120-127
	<b>Case Quantity</b>	12	12	12	6

Box Pack

LEVERS GROUP E	Function	101 Hall/Closet	331 Bed/Bath	535 Keyed Entry	12 Inactive LH	12 Inactive RH
	List Price	\$75	\$92	\$145	\$40	\$40

Visual Pack

TOLUCA	Finish Availability	GLA 101 TC	GLA 331 TC	GLA 535 TC	GLA 12 TC	GLA 12 TC
 <b>MICROBAN</b>	3 Brass	9GLA1010-048	9GLA3310-047	9GLA5350-067	9GLA120-032	9GLA120-033
	11P Venetian Bronze	9GLA1010-053	9GLA3310-052	9GLA5350-076	9GLA120-038	9GLA120-039
	15 Satin Nickel	9GLA1010-050	9GLA3310-049	9GLA5350-071	9GLA120-034	9GLA120-035
	514 Matte Black	9GLA1010-118	9GLA3310-117	9GLA5350-147	9GLA120-111	9GLA120-112
	<b>Case Quantity</b>	4	4	4	4	4

Parts

<b>KNOBS GROUP A</b>	<b>Function</b>	101 Hall/Closet	331 Bed/Bath	531 Keyed Entry	12 Inactive
	<b>List Price</b>	\$85	\$102	\$155	\$46

<b>WICKHAM</b>	Finish Availability	GCA 101 WK	GCA 331 WK	GCA 531 WK	GCA 12 WK
	15 Satin Nickel	9GCA1010-024	9GCA3310-024	9GCA5310-040	9GCA120-013
	514 Matte Black	9GCA1010-026	9GCA3310-026	9GCA5310-048	9GCA120-015
	<b>Case Quantity</b>	4	4	4	4

**MICROBAN**

<b>KNOBS GROUP B</b>	<b>Function</b>	101 Hall/Closet	331 Bed/Bath	531 Keyed Entry	12 Inactive
	<b>List Price</b>	\$68	\$85	\$141	\$34

<b>PRAGUE</b>	Finish Availability	GLA 101 PGK	GLA 331 PGK	GLA 531 PGK	GLA 12 PGK
	15 Satin Nickel	9GA1010-153	9GA3310-156	9GA5310-211	9GA120-100
	514 Matte Black	9GA1010-154	9GA3310-157	9GA5310-212	9GA120-101
	<b>Case Quantity</b>	4	4	4	4

**MICROBAN**

<b>KNOBS GROUP C</b>	<b>Function</b>	101 Hall/Closet	331 Bed/Bath	531 Keyed Entry	12 Inactive
	<b>List Price</b>	\$64	\$81	\$134	\$32

<b>CAMBIE</b>	Finish Availability	GA 101 CBK	GA 331 CBK	GA 531 CBK	GA 12 CBK
	15 Satin Nickel	9GA1010-147	9GA3310-150	9GA5310-188	9GA120-094
	514 Matte Black	9GA1010-148	9GA3310-151	9GA5310-189	9GA120-095
	<b>Case Quantity</b>	4	4	4	4

**MICROBAN**

Intro

Electronics

Box Pack

Visual Pack

Parts

Intro

Electronics

Box Pack

Visual Pack

Parts

<b>KNOBS GROUP D</b>	<b>Function</b>	101 Hall/Closet	331 Bed/Bath	531 Keyed Entry	12 Inactive
	<b>List Price</b>	\$58	\$75	\$128	\$31

<b>HUNTINGTON</b>		Finish Availability	GA 101 HT	GA 331 HT	GA 531 HT	GA 12 HT
 <b>MICROBAN</b>	3	Brass	9GA1010-017	9GA3310-016	9GA5310-055	9GA120-010
	15	Satin Nickel	9GA1010-020	9GA3310-019	9GA5310-057	9GA120-012
	26D	Satin Chrome	9GA1010-022	9GA3310-021	9GA5310-058	9GA120-013
	<b>Case Quantity</b>			4	4	4

Note: Microban is available on the following finishes: 3, 15

<b>PHOENIX</b>		Finish Availability	GA 101 P	GA 331 P	GA 531 P	GA 12 P
 <b>MICROBAN</b>	11P	Venetian Bronze	9GA1010-015	9GA3310-014	9GA5310-054	9GA120-009
	15	Satin Nickel	9GA1010-011	9GA3310-010	9GA5310-052	9GA120-007
	15A	Antique Nickel	9GA1010-013	9GA3310-012	9GA5310-053	9GA120-008
	<b>Case Quantity</b>			4	4	4

<b>KNOBS GROUP E</b>	<b>Function</b>	101 Hall/Closet	331 Bed/Bath	531 Keyed Entry	12 Inactive
	<b>List Price</b>	\$50	\$67	\$120	\$26

<b>TROY</b>		Finish Availability	GA 101 T	GA 331 T	GA 531 T	GA 12 T
 <b>MICROBAN</b>	11P	Venetian Bronze	9GA1010-007	9GA3310-007	9GA5310-050	9GA120-005
	15	Satin Nickel	9GA1010-003	9GA3310-003	9GA5310-047	9GA120-002
	26D	Satin Chrome	9GA1010-006	9GA3310-006	9GA5310-049	9GA120-004
	514	Matte Black	9GA1010-009	9GA3310-009	9GA5310-051	9GA120-006
	<b>Case Quantity</b>			4	4	4

Note: Microban is available on the following finishes: 11P, 15, 514

DOWNTOWN GD 1471	Finish Availability		GD 1471 SQT Single Cylinder
		4	Satin Brass
	11P	Venetian Bronze	9GD14710-019
	15	Satin Nickel	9GD14710-017
	26	Polished Chrome	9GD14710-021
	514	Matte Black	9GD14710-023
	<b>List Price</b>		\$111
	<b>Case Quantity</b>		4

**MICROBAN**

Note: Microban is available on the following finishes: 4, 11P, 15, 514

UPTOWN GD 1471	Finish Availability		GD 1471 RDT Single Cylinder
		15	Satin Nickel
	514	Matte Black	9GD14710-024
	<b>List Price</b>		\$111
	<b>Case Quantity</b>		4

**MICROBAN**

MIDTOWN GD 1471	Finish Availability		GD 1471 Single Cylinder
		15	Satin Nickel
	514	Matte Black	9GD14710-034
	<b>List Price</b>		\$111
	<b>Case Quantity</b>		4

**MICROBAN**

GCD 9471	Finish Availability		GCD 9471 Single Cylinder Square Face Latch	GCD 9471 Single Cylinder Drive-In Latch
		15	Satin Nickel	9GCD94710-050
	514	Matte Black	9GCD94710-055	9GCD94710-054
	<b>List Price</b>		\$103	\$103
	<b>Case Quantity</b>		4	4

**MICROBAN**

Intro

Electronics

Box Pack

Visual Pack

Parts

GD 9471/9371	Finish Availability		GD 9471 Single Cylinder	GD 9371 Double Cylinder
		3BR	Lifetime Brass	9GD94710-091
	11P	Venetian Bronze	9GD94710-084	
	15	Satin Nickel	9GD94710-087	9GD93710-040
	15A	Antique Nickel	9GD94710-089	
	26D	Satin Chrome	9GD94710-090	9GD93710-042
	514	Matte Black	9GD94710-085	
		<b>List Price</b>	\$99	\$131
		<b>Case Quantity</b>	4	4

Note: Microban is available for GD 9471 on the following finishes: 11P, 15, 15A, 514

SSD 9471 SQUARE	Finish Availability		SSD 9471 SQT
		15	Satin Nickel
		<b>List Price</b>	\$71
		<b>Case Quantity</b>	4



SSD 9471 ROUND	Finish Availability		SSD 9471 RDT
		15	Satin Nickel
		<b>List Price</b>	\$71
		<b>Case Quantity</b>	4





GCD 9571 SQT KEY CONTROL DEADBOLT	Finish Availability		GCD 9571 SQT UL Single Cylinder 3HR UL
		26D	Satin Chrome
		<b>List Price</b>	\$111
		<b>Case Quantity</b>	4



\*Cylinder cap removed to show both cylinders



<b>CAMBIE</b>		Finish Availability	GACS741	GACS7481
			Deadbolt x Keyed Knob	Deadbolt x Passage Knob
	15	Satin Nickel	9GACS74510-025	
	514	Matte Black		9GACS74810-003
		<b>List Price</b>	\$185	\$119
		<b>Case Quantity</b>	4	4



<b>TROY</b>		Finish Availability	GSC7451
			Deadbolt x Keyed Knob
	26D	Satin Chrome	9GSC74510-012
		<b>List Price</b>	\$180
		<b>Case Quantity</b>	4

<b>TOLUCA</b>		Finish Availability	GSL7481
			Deadbolt x Passage Lever
	15	Satin Nickel	9GSL74810-001
		<b>List Price</b>	\$152
		<b>Case Quantity</b>	4



**ROUND POCKET DOORLOCK**



Finish Availability		WR1030 Passage	WR1031 Privacy
15	Satin Nickel	9WR10300-003	9WR10310-003
<b>List Price</b>		\$41	\$45
<b>Case Quantity</b>		6	6

**SQUARE POCKET DOORLOCK**



Finish Availability		W1030 Passage	W1031 Privacy
11P	Venetian Bronze	9W10300-008	9W10310-016
15	Satin Nickel	9W10300-003	9W10310-010
26D	Satin Chrome	9W10300-011	9W10310-013
<b>List Price</b>		\$41	\$45
<b>Case Quantity</b>		6	6

**SMARTKEY PADLOCK**



Finish Availability		026 STD SHKL 1-1/8"	026 LNG SHKL 2"
SmartKey Padlock		9GPL0260-001	9GPL0260-002
<b>List Price</b>		\$38	\$41
<b>Case Quantity</b>		6	6

Intro

Electronics

Box Pack

Visual Pack

Parts





**ELEMENTS**

visual pack

ELEMENTS





by Weiser

HANDLESETS GROUP A	Function	GLC9471 Single Cylinder	GLC9471 Single Cylinder	GLC9471 Single Cylinder
	List Price	\$252	\$252	\$252

AMADOR	Finish Availability	GLC9471 AMD/TSL	GLC9471 AMD/CSL	GLC9471 AMD/HSL
	15 Satin Nickel	9GLC94710-019	9GLC94710-020	9GLC94710-022
	514 Matte Black	9GLC94710-018	9GLC94710-021	9GLC94710-023
	Interior			
	Case Quantity	2	2	2

MICROBAN<sup>®</sup>

HANDLESETS GROUP B	Function	9471 Single Cylinder	9471 Single Cylinder
	List Price	\$225	\$225

BRENTWOOD	Finish Availability	GLC9471 BDH/BLM	GAC9471 BDH/F
	3 Brass	9GLC94710-005	
	11P Venetian Bronze	9GLC94710-004	
	15 Satin Nickel	9GLC94710-006	9GAC94710-008
	26D Satin Chrome	9GLC94710-007	
	514 Matte Black	9GLC94710-017	
	Interior		
	Case Quantity	2	2

MICROBAN<sup>®</sup>

Note: Microban is available on the following finishes: 3, 11P, 15, 514

KINGSWAY	Finish Availability	GAC9471 K/F	GAC9471 K/Y
	3BR Lifetime Brass		9GAC94710-001
	11P Venetian Bronze	9GAC94710-003	
	15 Satin Nickel		9GAC94710-007
	26D Satin Chrome		9GAC94710-002
	Interior		
	Case Quantity	2	2

MICROBAN<sup>®</sup>

Note: Microban is available on the following finishes: 11P, 15

Intro

Electronics

Box Pack

Visual Pack

Parts

**ELEMENTS**  
by **WEISER**

LEVERS GROUP A	Function	101 Hall/Closet	331 Bed/Bath	535 Keyed Entry	12 Inactive
	List Price	\$73	\$82	\$122	\$48

BRETON	Finish Availability	GLC 101 BRNL	GLC 331 BRNL	GLC 535 BRNL	GLC 12 BRNL
	15 Satin Nickel	9GLC1010-068	9GLC3310-068	9GLC5350-094	9GLC120-098
	26D Satin Chrome	9GLC1010-070	9GLC3310-070	9GLC5350-096	9GLC120-100
	514 Matte Black	9GLC1010-069	9GLC3310-069	9GLC5350-095	9GLC120-099
<b>MICROBAN</b>	<b>Case Quantity</b>	4	4	4	4

Note: Microban is available on the following finishes: 15, 514

LEVERS GROUP B	Function	101 Hall/Closet	331 Bed/Bath	535 Keyed Entry	12 Inactive LH	12 Inactive RH
	List Price	\$67	\$76	\$116	\$40	\$40

KIM	Finish Availability	GLC 101 KML	GLC 331 KML	GLC 535 KML	GLC 12 KML
	26D Satin Chrome	9GLC1010-043	9GLC3310-043	9GLC5350-060	9GLC120-061
	<b>Case Quantity</b>	6	6	6	4

TRISTAN SQUARE ROSE	Finish Availability	GLC 101 TSL	GLC 331 TSL	GLC 535 TSL	GLC 12 TSL LH	GLC 12 TSL RH
	15 Satin Nickel	9GLC1010-058	9GLC3310-058	9GLC5350-075	9GLC120-084	9GLC120-085
	514 Matte Black	9GLC1010-059	9GLC3310-059	9GLC5350-076	9GLC120-086	9GLC120-087
	<b>Case Quantity</b>	6	6	6	4	4

CASEY	Finish Availability	GLC 101 CSL	GLC 331 CSL	GLC 535 CSL	GLC 12 CSL
	15 Satin Nickel	9GLC1010-071	9GLC3310-071	9GLC5350-097	9GLC120-101
	514 Matte Black	9GLC1010-072	9GLC3310-072	9GLC5350-098	9GLC120-102
	<b>Case Quantity</b>	4	4	4	4

HOLLIS	Finish Availability	GLC 101 HSL	GLC 331 HSL	GLC 535 HSL	GLC 12 HSL
	15 Satin Nickel	9GLC1010-073	9GLC3310-073	9GLC5350-099	9GLC120-103
	514 Matte Black	9GLC1010-074	9GLC3310-074	9GLC5350-100	9GLC120-104
	<b>Case Quantity</b>	4	4	4	4

**ELEMENTS**  
by WEISER

LEVERS GROUP C	Function	101 Hall/Closet	331 Bed/Bath	535 Keyed Entry	12 Inactive LH	12 Inactive RH
	List Price	\$60	\$70	\$96	\$38	\$38

BELMONT	Finish Availability	GLC 101 BLM	GLC 331 BLM	GLC 535 BLM	GLC 12 BLM LH	GLC 12 BLM RH
	3 Brass	9GLC1010-014	9GLC3310-014	9GLC5350-031	9GLC120-013	9GLC120-018
	5 Antique Brass	9GLC1010-015	9GLC3310-015	9GLC5350-032	9GLC120-014	9GLC120-019
	11P Venetian Bronze	9GLC1010-016	9GLC3310-016	9GLC5350-033	9GLC120-015	9GLC120-020
	15 Satin Nickel	9GLC1010-017	9GLC3310-017	9GLC5350-034	9GLC120-016	9GLC120-021
	26D Satin Chrome	9GLC1010-018	9GLC3310-018	9GLC5350-035	9GLC120-017	9GLC120-022
	514 Matte Black	9GLC1010-057	9GLC3310-057	9GLC5350-074	9GLC120-082	9GLC120-083
<b>Case Quantity</b>		6	6	6	4	4

**Note:** Microban is available on the following finishes: 3, 5, 11P, 15, 514

Intro

Electronics

Box Pack

Visual Pack

Parts



**ELEMENTS**  
by **WEISER**

KNOBS GROUP A	Function	101 Hall/Closet	331 Bed/Bath	531 Keyed Entry	12 Inactive
	List Price	\$44	\$53	\$79	\$26

FAIRFAX	Finish Availability	GAC 101 F	GAC 331 F	GAC 531 F	GAC 12 F
	3 Brass	9GAC1010-004	9GAC3310-004	9GAC5310-064	9GAC120-003
	11P Venetian Bronze	9GAC1010-008	9GAC3310-008	9GAC5310-043	9GAC120-006
	15 Satin Nickel	9GAC1010-033	9GAC3310-028	9GAC5310-069	9GAC120-024
	26D Satin Chrome	9GAC1010-007	9GAC3310-007	9GAC5310-067	9GAC120-005
	<b>Case Quantity</b>	6	6	6	6

**MICROBAN**

**Note:** Microban is available on the following finishes: 3, 11P, 15

YUKON	Finish Availability	GAC 101 Y	GAC 331 Y	GAC 531 Y	GAC 12 Y
	3 Brass	9GAC1010-009	9GAC3310-009	9GAC5310-068	9GAC120-007
	15 Satin Nickel	9GAC1010-011	9GAC3310-011	9GAC5310-046	9GAC120-008
	26D Satin Chrome	9GAC1010-013	9GAC3310-013	9GAC5310-048	9GAC120-009
	<b>Case Quantity</b>	6	6	6	6

**MICROBAN**

**Note:** Microban is available on the following finishes: 3, 15

KNOBS GROUP B	Function	101 Hall/Closet	301 Bed/Bath	501 Keyed Entry
	List Price	\$42	\$51	\$64

BEVERLY	Finish Availability	GAC 101 B 9/32D	GAC 301 B 9/32D	GAC 501 B 9/32D
	9/32D Bright Bronze/ Satin Chrome	9GAC1010-044	9GAC3010-005	9GAC5010-010
	<b>Case Quantity</b>	6	6	6

**Note:** 9/32D uses the legacy Weiser pin & tumbler only

ELEMENTS

by WEISER

GDC 9471	Finish Availability	GDC 9471 Single Cylinder
 <p>MICROBAN</p>	3BR Lifetime Brass	9GDC94710-061
	11P Venetian Bronze	9GDC94710-058
	15 Satin Nickel	9GDC94710-059
	26D Satin Chrome	9GDC94710-060
	<b>List Price</b>	\$56
	<b>Case Quantity</b>	6

**Note:** Microban is available on the following finishes: 11P, 15

GDC 9471 SQT	Finish Availability	GDC9471 SQT Single Cylinder
 <p>MICROBAN</p>	15 Satin Nickel	9GDC94710-062
	514 Matte Black	9GDC94710-063
	<b>List Price</b>	\$61
	<b>Case Quantity</b>	6

GDC 9471 RDT	Finish Availability	GDC9471 RDT Single Cylinder
 <p>MICROBAN</p>	15 Satin Nickel	9GDC94710-073
	26D Satin Chrome	9GDC94710-075
	514 Matte Black	9GDC94710-074
	<b>List Price</b>	\$62
	<b>Case Quantity</b>	6

**Note:** Microban is available on the following finishes: 15, 514

Intro  
Electronics  
Box Pack  
Visual Pack  
Parts





**ELEMENTS**  
by **WEISER**

BELMONT	Finish Availability	GAC7451
		Deadbolt x Keyed Lever
	15 Satin Nickel	9GLCS74510-002
	<b>List Price</b>	\$129
	<b>Case Quantity</b>	4



CASEY	Finish Availability	GLC7451
		Deadbolt x Keyed Lever
	15 Satin Nickel	9GLCS74510-003
	514 Matte Black	9GLCS74510-005
	<b>List Price</b>	\$153
<b>Case Quantity</b>	4	



HOLLIS	Finish Availability	GLC7451
		Deadbolt x Keyed Lever
	15 Satin Nickel	9GLCS74510-004
	514 Matte Black	9GLCS74510-006
	<b>List Price</b>	\$153
<b>Case Quantity</b>	4	



Intro

Electronics

Box Pack

**Visual Pack**

Parts

**ELEMENTS**  
by WEISER

Intro



FAIRFAX		Finish Availability	GAC7481
			Deadbolt x Keyed Knob
26D	Satin Chrome		9GACS74810-001
		<b>List Price</b>	\$97
		<b>Case Quantity</b>	4

Electronics



FAIRFAX		Finish Availability	GAC7451
			Deadbolt x Keyed Knob
15	Satin Nickel		9GACS74510-018
		<b>List Price</b>	\$109
		<b>Case Quantity</b>	4



Box Pack

Visual Pack



YUKON		Finish Availability	GAC7451
			Deadbolt x Keyed Knob
3	Brass		9GACS74510-019
15	Satin Nickel		9GACS74510-022
26D	Satin Chrome		9GACS74510-021
		<b>List Price</b>	\$109
		<b>Case Quantity</b>	4



Parts



# SAFE LOCK

visual pack

# SAFE LOCK

<b>BRANTON X WESTLEY</b>	<b>Function</b>	SH1100 Single Cylinder	SH1100 Single Cylinder
	<b>List Price</b>	\$192	\$192

<b>BRANTON</b>	Finish Availability	SH1100BRNHXWTL	SH1100BRNHXREL
	15 Satin Nickel	9SH11000-022	9SH11000-025
	26D Satin Chrome	9SH11000-023	
	514 Matte Black		9SH11000-026
	Interior	Westley	Reminy
	<b>Case Quantity</b>	2	2

<b>DAYTONA X REGINA</b>	<b>Function</b>	SH1100 Single Cylinder	SH1100 Single Cylinder
	<b>List Price</b>	\$170	\$184

<b>DAYTONA</b>	Finish Availability	SH1100DTXRG	SH1100DTXLY
	3 Polished Brass	9SH11000-008	
	11P Venetian Bronze		9SH11000-016
	15 Satin Nickel	9SH11000-010	9SH11000-017
	26D Satin Chrome	9SH11000-009	
	514 Matte Black	9SH11000-024	
	Interior	Regina	Layton
<b>Case Quantity</b>	2	2	

Intro

Electronics

Box Pack

Visual Pack

Parts

# SAFE LOCK

REMINY GROUP A	Function	1000 Hall/Closet	3000 Bed/Bath	5000 Keyed Entry	7000 Inactive
	List Price	\$55	\$61	\$76	\$35

REMINY	Finish Availability	SL1000REL	SL3000REL	SL5000REL	SL7000REL
	15 Satin Nickel	9SL10000-119	9SL30000-093	9SL50000-118	9SL70000-073
	514 Matte Black	9SL10000-120	9SL30000-094	9SL50000-119	9SL70000-074
<b>Case Quantity</b>		6	6	6	4

WESTLEY GROUP A	Function	1000 Hall/Closet	3000 Bed/Bath	5000 Keyed Entry	7000 Inactive
	List Price	\$55	\$61	\$76	\$34

WESTLEY	Finish Availability	SL1000WTL	SL3000WTL	SL5000WTL	SL7000WTL
	15 Satin Nickel	9SL10000-072	9SL30000-071	9SL50000-065	9SL70000-049
	26D Satin Chrome	9SL10000-073	9SL30000-072	9SL50000-066	9SL70000-050
<b>Case Quantity</b>		6	6	6	4

DAYLON GROUP A	Function	1000 Hall/Closet	3000 Bed/Bath	5000 Keyed Entry	7000 Inactive
	List Price	\$55	\$61	\$76	\$35

DAYLON	Finish Availability	SL1000DAL	SL3000DAL	SL5000DAL	SL7000DAL
	15 Satin Nickel	9SL10000-080	9SL30000-077	9SL50000-067	9SL70000-055
	514 Matte Black	9SL10000-085	9SL30000-082	9SL50000-068	9SL70000-060
<b>Case Quantity</b>		6	6	6	4

# SAFE LOCK

GRAPEVINE GROUP A	Function	1000 Hall/Closet	3000 Bed/Bath	5000 Keyed Entry	7000 Inactive
	List Price	\$48	\$55	\$69	\$27

GRAPEVINE	Finish Availability	SL1000GV	SL3000GV	SL5000GV	SL7000GV
	11P Venetian Bronze	9SL10000-025	9SL30000-025	9SL50000-019	9SL70000-013
	15 Satin Nickel	9SL10000-023	9SL30000-023	9SL50000-017	9SL70000-011
	514 Matte Black	9SL10000-114	9SL30000-091	9SL50000-116	9SL70000-067
<b>Case Quantity</b>		6	6	6	4

LAYTON GROUP A	Function	1000 Hall/Closet	3000 Bed/Bath	5000 Keyed Entry	7000 Inactive LH	7000 Inactive RH
	List Price	\$50	\$57	\$71	\$29	\$29

LAYTON	Finish Availability	SL1000LY	SL3000LY	SL5000LY	SL7000LY	SL7000LY
	11P Venetian Bronze	9SL10000-033	9SL30000-033	9SL50000-026	9SL70000-021	9SL70000-022
	15 Satin Nickel	9SL10000-034	9SL30000-034	9SL50000-027	9SL70000-023	9SL70000-024
	514 Matte Black	9SL10000-115	9SL30000-092	9SL50000-117	9SL70000-068	9SL70000-069
<b>Case Quantity</b>		6	6	6	4	4

Intro  
Electronics  
Box Pack  
Visual Pack  
Parts

# SAFE LOCK

<b>WINSTON GROUP A</b>	<b>Function</b>	1000 Hall/Closet	3000 Bed/Bath	5000 Keyed Entry	7000 Inactive
	<b>List Price</b>	\$55	\$61	\$76	\$35

<b>WINSTON</b>	Finish Availability	SL1000WI	SL3000WI	SL5000WI	SL7000WI
	15 Satin Nickel	9SL10000-112	9SL30000-089	9SL50000-114	9SL70000-065
	514 Matte Black	9SL10000-113	9SL30000-090	9SL50000-115	9SL70000-066
	<b>Case Quantity</b>	6	6	6	4

<b>WINSTON GROUP B</b>	<b>Function</b>	1000 Hall/Closet	3000 Bed/Bath	5000 Keyed Entry	7000 Inactive
	<b>List Price</b>	\$47	\$53	\$68	\$26

<b>WINSTON</b>	Finish Availability	SL1000WI	SL3000WI	SL5000WI	SL7000WI
	15 Satin Nickel	9SL10000-028	9SL30000-028	9SL50000-022	9SL70000-016
	<b>Case Quantity</b>	6	6	6	4

<b>WINSTON GROUP C</b>	<b>Function</b>	1000 Hall/Closet	3000 Bed/Bath	5000 Keyed Entry	7000 Inactive
	<b>List Price</b>	\$44	\$50	\$65	\$23

<b>WINSTON</b>	Finish Availability	SL1000WI	SL3000WI	SL5000WI	SL7000WI
	26D Satin Chrome	9SL10000-027	9SL30000-027	9SL50000-021	9SL70000-015
	<b>Case Quantity</b>	6	6	6	4

# SAFE LOCK

ATHENS	<b>Function</b>	1000 Hall/Closet	3000 Bed/Bath	5000 Keyed Entry
	<b>List Price</b>	\$33	\$36	\$48

ATHENS	Finish Availability	SK1000AS	SK3000AS	SK5000AS
	11P Venetian Bronze	9SK10000-029	9SK30000-029	9SK50000-023
	15 Satin Nickel	9SK10000-027	9SK30000-027	9SK50000-021
	<b>Case Quantity</b>	6	6	6

REGINA GROUP A	<b>Function</b>	1000 Hall/Closet	3000 Bed/Bath	5000 Keyed Entry	7000 Inactive
	<b>List Price</b>	\$31	\$35	\$47	\$22

REGINA	Finish Availability	SK1000RG	SK3000RG	SK5000RG	SK7000RG
	514 Matte Black	9SK10000-054	9SK30000-054	9SK50000-065	9SK70000-025
	<b>Case Quantity</b>	6	6	6	4

REGINA GROUP B	<b>Function</b>	1000 Hall/Closet	3000 Bed/Bath	5000 Keyed Entry	7000 Inactive
	<b>List Price</b>	\$31	\$35	\$47	\$21

REGINA	Finish Availability	SK1000RG	SK3000RG	SK5000RG	SK7000RG
	11P Venetian Bronze	9SK10000-026	9SK30000-026	9SK50000-020	9SK70000-014
	15 Satin Nickel	9SK10000-025	9SK30000-025	9SK50000-019	9SK70000-013
	<b>Case Quantity</b>	6	6	6	4

REGINA GROUP C	<b>Function</b>	1000 Hall/Closet	3000 Bed/Bath	5000 Keyed Entry	7000 Inactive
	<b>List Price</b>	\$28	\$32	\$44	\$19

REGINA	Finish Availability	SK1000RG	SK3000RG	SK5000RG	SK7000RG
	3 Polished Brass	9SK10000-023	9SK30000-023	9SK50000-017	9SK70000-011
	26D Satin Chrome	9SK10000-024	9SK30000-024	9SK50000-018	9SK70000-012
	<b>Case Quantity</b>	6	6	6	4

Intro

Electronics

Box Pack

Visual Pack

Parts



# SAFE LOCK

DEADBOLT	Finish Availability		SD9100 Single Cylinder	SD9100 Single Cylinder
	3	Brass	9SD91000-011	
	11P	Venetian Bronze		9SD91000-015
	15	Satin Nickel		9SD91000-013
	26D	Satin Chrome	9SD91000-012	
	514	Matte Black		9SD91000-042
		<b>List Price</b>		\$38
	<b>Case Quantity</b>		6	6

COMBO PACK	Finish Availability		SC60000RG
  	15	Satin Nickel	9SC60000-001
		<b>List Price</b>	\$69
		<b>Case Quantity</b>	6



# PARTS

**KEYS / REKEYING**

**SMART KEY MODEL FUNCTION QTY LIST PRICE**

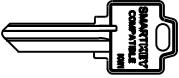
	800004-355	SmartKey Keyblank (KW1 Compatible) - Single Blank	50	\$2.20
	800004-353	SmartKey Cut Key (KW1 Compatible) - Includes 2 Keys On Ring	each	\$4.50

**PIN & TUMBLER MODEL FUNCTION**

			Price	QTY	0 - 99	100 - 999	1000 - 4999	5000+
	800004-342	Weiser Builder Cut Key mk		each	\$2.08	\$1.56	\$1.35	\$1.24
	800004-340	Weiser Builder Cut Key cck		each				
	1556	Pin & Tumbler Cut Key 5 Pin	\$3.54	each				

**KEY CONTROL MODEL FUNCTION FINISH LIST PRICE**

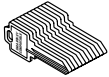
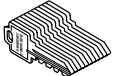
	MODEL	FUNCTION	FINISH						QUANTITY	LIST PRICE
			3	5	11P/514	15	26D	NA		
	820231	Key Control Deadbolt Key Blanks						001	1	\$4.30
	820204	Key Control Deadbolt Cut Keys						001	1	\$4.80

**PRIVACY LOCK EMERGENCY KEY MODEL FUNCTION QTY LIST PRICE**

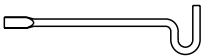
	81087-001	For All Privacy Function Locksets	100 box / each	\$0.80
-------------------------------------------------------------------------------------	-----------	-----------------------------------	----------------	--------



**SMARTKEY REKEY KITS MODEL FUNCTION LIST PRICE**

	820062-001	Carded VP Rekey Kit (4 silver/2 brass)	\$25.50
-------------------------------------------------------------------------------------	------------	----------------------------------------	---------

**SMARTKEY REKEYING TOOLS MODEL FUNCTION LIST PRICE**

	800004-351	Steel Learn Tool (Qty 10)	\$3.20
	83260-001	Reset Cradle	\$45
	83338-001	Large Knob/Lever C-clip (each)	\$1.10
	83337-001	Large Deadbolt C-clip (each)	\$1.10

Intro  
Electronics  
Box Pack  
Visual Pack  
Parts

<b>WEISER P&amp;T REKEY SUPPLIES</b>	<b>MODEL</b>	<b>FUNCTION</b>	<b>LIST PRICE</b>	<b>QTY</b>
	800000-041	Cylinder Cap Tool	\$10	each
	800000-126	Top Pins	\$10	100
	800000-127 - 136	Bottom Pins	\$10	100
	800000-167 - 174	Master Wafers	\$10	100

<b>KWIKSET P&amp;T REKEY SUPPLIES</b>	<b>MODEL</b>	<b>FUNCTION</b>	<b>QTY</b>	<b>LIST PRICE</b>
	80369-001	PK Anti-Pick Top Pin .160"	Bag/100	\$10
	80370-001	Regular Anti-Pick Top Pin .180"	Bag/100	\$10
	81467-003	Cylinder Removal Tool	each	\$10
	81777-001	Tumbler Spring	Bag/100	\$10
	81858-001	Regular Top Pin .180"	Bag/100	\$10
	82208-001	PK Balls	Bag/100	\$10
	83100-001	#1 Bottom Pin .172"	Bag/100	\$10
	83101-001	#2 Bottom Pin .195"	Bag/100	\$10
	83103-001	#3 Bottom Pin .218"	Bag/100	\$10
	83105-001	#4 Bottom Pin .241"	Bag/100	\$10
	83106-001	#5 Bottom Pin .264"	Bag/100	\$10
	83107-001	#6 Bottom Pin .287"	Bag/100	\$10
	83108-001	#1 Master Pin .023"	Bag/100	\$10
	83110-001	#2 Master Pin .046"	Bag/100	\$10
	83112-001	#3 Master Pin .069"	Bag/100	\$10
	83113-001	#4 Master Pin .092"	Bag/100	\$10
	83114-001	#5 Master Pin .115"	Bag/100	\$10
	83125-001	#6 Master Pin .138"	Bag/100	\$10
	83117-001	PK Top Pin .160"	Bag/100	\$10
	83561-001	Spring Cover (6-Pin)	Bag/100	\$10
	84345-001	Knob Plug Retainer	Bag/100	\$10
	84215-001	Deadlock Plug Retainer	Bag/100	\$10
	85757-001	Spring Cover (5-Pin)	Bag/50	\$5
	87632-001	Spring	Bag/100	\$10
	87809-001	Deadlock Control Lug (Locking Bar)	Bag/100	\$10

**CYLINDERS - SMARTKEY**

**SMARTKEY  
CYLINDERS  
HOUSING**



MODEL	FUNCTION	FINISH										LIST PRICE		
		3	3BR	5	15	15A	26	26D	11P	502	514			
820010	Knob, GA531, Huntington	-001	-002	-003	-004					-006	-005			\$33
820011	Knob, GA531, Phoenix				-002	-003					-001			\$33
820028	External GDC 9471/ GAC9471 Single Cylinder	-001	-002	-003	-004	-005	-006	-007	-008				TBD	\$31
800004	External GCD 9471 Single Cylinder			-525	-527		-528	-529	-526				-531	\$74

**SMARTKEY  
CYLINDERS  
PLUGS**

MODEL	FUNCTION	FINISH				LIST PRICE
		Black	Brown	Gold	Silver	
800004	Laurel & Levers, Fairfax, Yukon	-385	-384	-381	-382	\$29
820280	GD9471	-004	-003	-001	-002	\$29
83025	GD1471	-003		-002	-001	\$29

Intro  
Electronics  
Box Pack  
Visual Pack  
Parts

**GD 9471 WEISER  
DEADBOLT CYLINDERS  
PLUGS**

	MODEL	FUNCTION	FINISH				LIST PRICE
			Gold	Silver	Bronze	Black	
	820313	GD 9471 Single Cylinder Plug WS	-001	-003	-007	-008	\$23.50
	820312	GD 9471 Single Cylinder Plug KW	-001	-003	-007	-008	\$23.50

Intro

Electronics

Box Pack

Visual Pack

**Parts**

**WS:** Weiser Pin & Tumbler  
**KW1:** SmartKey Compatible Pin & Tumbler

**DEADBOLT LATCHES**

**DEADBOLT  
ADJUSTABLE  
LATCHES**

	MODEL	FUNCTION	FINISH							LIST PRICE	
			3	5	15/502	15A	26/26D	690/11P/501	514		NA
<b>DI</b>											
	81306-003	GDC 9471 / 9371 Deadbolt								•	\$15
	83371-003	GD/GCD 9471/9371 Deadbolt								•	\$36.50

**6L**

	820288	GD/GDC 9471/9371 Deadbolt Box Pack					-001				\$23.50
	820288	GD/GDC 9471/9371 Deadbolt Box Pack			-002			-003			\$22.50
	820288	GD/GDC 9471/9371 Deadbolt Box Pack	-004	-005		-006			-007		\$21.50
	820310	GD/GDC 9471/9371 Deadbolt Visual Pack	-003		-001		-002				\$22.50
	820317	GD 1471 Deadbolt Box Pack			-001		-002	-003	-004		\$33

**ELECTRONICS  
TAPERED LATCH**

	820316	Smartcode Tapered Latch - Square Corner	-001		-003			-002			\$40.50
	80393	Smartcode Tapered Latch - Drive-In	-001		-003			-002			\$43
	83546	Powerbolt 2 Latch - 6WAL	-002		-001			-003			\$22.50

**DEADBOLT  
SPECIALTY LATCHES**

			3	5	15/502	15A	26/26D	690/11P/501	NA		
<b>5L</b>											
	820046	5" Latch (replacement part only)	-001	-002			-003				\$19.50

**GATELATCH**

			3	5	15/502	15A	26/26D	690/11P/501	NA	
	820233	Gatelatch 2 3/8"	-001	-002			-004	-005		\$31
	820234	Gatelatch 2 3/4"	-001	-002			-004	-005		\$31

**GATELATCH  
HOLDBACK KIT**

			3	5	15/502	15A	26/26D	690/11P/501	NA	
	820235	Gatelatch Holdback Kit 2 3/8"	-001		-003		-004	-005		\$70.50
	820236	Gatelatch Holdback Kit 2 3/4"	-001	-002	-003		-004	-005		\$70.50

**KEY:**  
 5L - 5" Latch  
 6L - Six-Way Adjustable Latch  
 RCAL - Round Corner Adjustable

Latch  
 DI - Drive In Adjustable Latch  
 SCAL - Square Corner Adjustable Latch

Intro  
Electronics  
Box Pack  
Visual Pack  
Parts

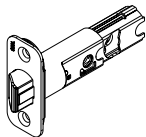
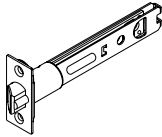

**FIXED FACE LATCH**

	MODEL	FUNCTION	FINISH								LIST PRICE
			3	5	15/502	15A	26/26D	690/11P/501	514	NA	
	820047	RCAL Plain Latch	-001	-002	-005	-006	-003	-004	-007		\$17
	820053	RCAL Dead Latch	-001	-002	-005	-006	-003	-004	-007		\$18
	820048	SCAL Plain Latch	-001	-002	-005	-006	-003	-004	-007		\$17
	820079	SCAL Dead Latch	-001	-002	-005		-003	-004			\$18
	820079	SCAL Dead Latch				-006			-007		\$17
	820051	DI Plain Latch								-001	\$15
	820080	DI Dead Latch								-001	\$16
	820061	5" Latch (replacement part only)	-001	-002			-003				\$23.50

**CORE LATCH\***

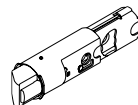
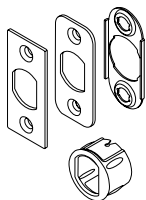
	81846	6-Way Core Deadlatch								-001	\$14
	81847	6-Way Core Plain Latch								-001	\$10.50
<p>* service kit required</p> 	820003	6-Way Core Deadlatch - VP	-001				-002				\$15
	820004	6-Way Core Plain Latch - VP	-001				-002				\$12
	820287	6-Way Core Plain Latch - Milan/Halifax (legacy)							-004		\$13
	820287	6-Way Core Plain Latch - Milan/Halifax (legacy)					-001	-003			\$15
	820287	6-Way Core Plain Latch - Milan/Halifax (legacy)			-002						\$16
	820081	6-Way Deadlatch Service Kit	-001	-002	-003	-004	-005	-006	-007		\$8.50
	820082	6-Way Plain Latch Service Kit	-001	-002	-003	-004	-005	-006	-007		\$8.50

**BACK PLATE**

	81827	6-Way Back Plate								-001	\$0.40
-------------------------------------------------------------------------------------	-------	------------------	--	--	--	--	--	--	--	------	--------

**DRIVE IN COLLAR**

	81828	6-Way Deadlatch Collar								-001	\$3.70
	81829	6-Way Plain Latch Collar								-001	\$3.70

**NOTES:**



All plain and dead latches can be used with all Weiser knob and lever products (except metro levers excluding Halifax). Plain latches are used with passage and privacy functions. Deadlatches are used with entry functions. All fronts are 2-1/4" high.

For fire rating, UL latches must be used with UL listed locksets and applicable strikes.

**STRIKES**

PLAIN LATCH	MODEL	FUNCTION	FINISH								LIST PRICE
			3	5	15/502	15A	26/26D	690/11P/501	514	NA	
	83028	T (1 per bag)	-001	-009	-015	-016	-003 -017	-014	-018		\$7
	83030	Full Lip Square Corner Strike, UL Option	-001	-002	-005	-006	-003	-004	-007		\$4.80
	83031	Full Lip 1/4" Round Corner Strike, UL Option	-001	-002	-005	-006	-003	-004	-007		\$4.80
	83437	Full Lip Square Corner Standard on Non-UL Locksets	-008		-034	-035	-036	-033	-040		\$4.80
	83796	Full Lip 1/4" Round Corner	-001	-002	-016	-017	-004	-014	-019		\$4.80
	83846	ASA-1 (1 per bag)	-001	-012	-015	-016	-004	-014	-017		\$6
	83929	Full Round 1- 3/4"			-006		-003		-008		\$4.80
	83536	Extended Lip Strike Round Corner	-001		-003		-002	-004			\$4.80
	83537	Extended Lip Strike Square Corner			-003		-002	-004			\$3.70
	83534	Adjustable Strike Round Corner	-001						-002		\$3.70
					-003		-004				\$4.80

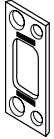
Intro  
Electronics  
Box Pack  
Visual Pack  
Parts

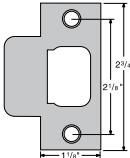
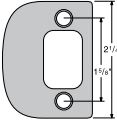
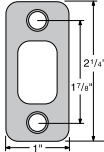
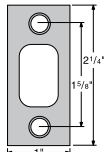
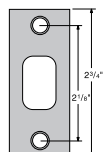
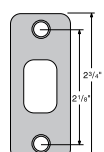
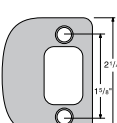
DEADBOLT	MODEL	FUNCTION	FINISH								LIST PRICE
			3	5	15/502	15A	26/26D	690/11P/501	514	NA	
	820049	Deadbolt Strike	-001	-002	-005	-006	-003	-004	-007		\$8
	820050	Deadbolt Round Corner Strike	-001	-002	-005		-003	-004			\$8
	84632	Deadbolt T-Strike (1 per bag)	-001		-005		-002	-004	-007		\$6
	84638	Deadbolt, Full Lip	-001		-008		-002	-004	-010		\$6
	85063	Deadbolt 1"x 2-1/4" Round Corner (RCS4)	-001	-005	-006	-007	-003	-002	-008		\$4.80
	85072	Deadbolt 1"x 2-1/4"	-001		-012	-013	-004	-003			\$4.80
	85278	Deadbolt, 1-1/8" x 2- 3/4"	-001	-006	-013	-014	-003	-012	-019		\$6
	85279	Deadbolt, 1-1/8" x 2- 3/4" Round Corner	-003	-005	-009	-010	-002 -011	-008	-015		\$6
	85303	Deadbolt, Full lip Round Corner	-001	-003	-014	-015	-006 -016	-010	-017		\$4.80

Intro

Electronics

Box Pack

Visual Pack

Parts

**STRIKES**

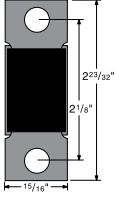
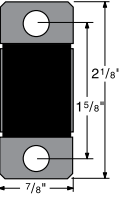
STRIKE BOXES	MODEL	FUNCTION	LIST PRICE
	81231-001	Box for 83028 T Strike	\$1.60
	83288-001	Box for Full Lip Strikes	\$3.70



Intro

Electronics





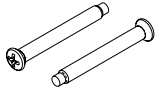
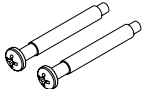

Box Pack

Visual Pack

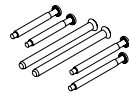
**Parts**

KNOBS & LEVERS	MODEL	FUNCTION	FINISH					LIST PRICE
			3/5	15/15A/502	26/26D	690/11P/501/514	NA	
	81834	Concealed Machine Screws GLA					-001	\$1.40
	81835	Exposed machine Screws used on all GA/GAC Knobs GLA/GLC Levers	-001	-005	-002	-006		\$1.40
	83258	Reversible Lever Hex Wrench (3/32")					-001	\$1.40
	820284	Metro Lever Screw Pack & Hex Wrench (Legacy)		-002	-001			\$3.20
						-003		\$4.30

REVERSIBLE LEVERSET SCREWS	MODEL	FUNCTION	FINISH					LIST PRICE
			3/5	15/15A/502	26/26D	690/11P/501/514	NA	
	83254	Passage/Privacy/Interior Entry SMT					-001	\$0.60
	83255	Interior Pin & Tumbler Entry					-001	\$0.60
	83256	Exterior Entry Pin & Tumbler & SMT					-001	\$0.60

HANDLESETS	MODEL	FUNCTION	FINISH					LIST PRICE
			3/5	15/15A/502	26/26D	690/11P/501/514	NA	
	86151	Elements Inner Trim Knob Lever Screws	-008	-007	-003	-006		\$2.40
	88322	Elements Handleset Bottom Sex Nut & Wood Screw	-003 -010	-009 -005	-002 -006	-004		\$8.50
	82215	Decorative Handleset Interior Screw Cap Cover	-001	-004 -003	-005 -006	-007 -010		\$2.90
	81696	Contemporary Handleset Interior Screw Cap Cover		-002	-003 -004	-001 -005		\$2.90
	83004	Screw & Washer (Standard Door)					-010	\$1.30
	81861	Screw & Washer (Thick Door) San Clemente / Camino Handlesets					-001	\$1.30

**SCREW PACKS**

**DECORATIVE SCREW CAP**

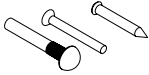
	MODEL	FUNCTION	FINISH					LIST PRICE
			3/5	15/15A/502	26/26D	690/11P/501/514	NA	
	81696	Contemporary Handleset Interior Screw Cap Cover		-002	-003 -004	-001 -005	-010	\$2.70

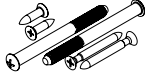
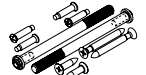
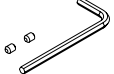
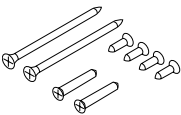
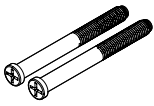

**DEADBOLTS**

	MODEL	FUNCTION	FINISH					LIST PRICE
			3/5	15/15A/502	26/26D	690/11P/501/514	NA	
	81247	Collections GCD 9471 Deadbolt Screw Pack	-007	-004	TBD	-008		\$7.50
	820083	Weiser GD 9471 Deadbolt Screw Pack	-001		-002	-004		\$7.50
	81251	GCD 9471 Series Deadbolt, Turnpiece Screw & #6 Wrench 6/32" (Legacy)					-002	\$7.50
	820285	SSD 9471 Deadbolt Screw Pack		-002	-001			\$4.70
	820286	Metropolitan SDD 9371 Deadbolt Screw Pack		-002	-001			\$10.50
	83017	GD 1471 Deadbolt Screw Pack 1-3/8" Door		-002	-001	-003		\$5.50
	83015	GD 1471 Deadbolt Screw Pack 1-3/4" Door		-002	-001	-003		\$5.50
	86171	Elements GDC 9471 Deadbolt Screw Pack	-001	-003	-002	-004		\$1.90

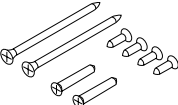
**STRIKES / LATCH**

	MODEL	FUNCTION	FINISH						LIST PRICE
			3	3BR	5	15/15A	26/26D	515	
	800001	Deadbolts	-735						\$7.50
	81711	Knobs & Levers	-001			-002	-003	-002	-004

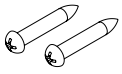
**INACTIVE**

	MODEL	FUNCTION	FINISH					LIST PRICE
			3	15/15A/502	26/26D	690/11P/501/514	NA	
	81708	Inactive Mounting Screws	-001		-002	-003		\$1.30
	81892	Inactive Adapter	-001		-002	-003		\$8.50

Intro

Electronics

Box Pack

Visual Pack

Parts

THICK DOOR CONVERSION	MODEL	FUNCTION	FINISH					LIST PRICE
			3/5	15/15A/502	26/26D	690/11P/501/514	NA	
	81691	GD 9471 Deadbolt Thick Door Pack	-006	-004	-002	-005		\$8.50
	86129	GDC 9471 Thick Door Pack	-001		-006	-008		\$8.50
	86130-009	6130-01 BLK LPP 665 Thick Door						\$8.50
	86130-008	6130-01 515 LPP 665 Thick Door						\$8.50
	81714	Thick Door Pack - Knob					-001	\$8.50
	81706	Thick Door Pack - Lever	-001	-004	-002	-008		\$8.50
	81838	Thick Door Pack - Handleset Adapter	-001		-002	-003		\$4.80
	81402	Handleset Thick Door Spindle					-003	\$3.70
	820289	SSD 9471 Thick Door Pack			-001	-003		\$7.50
				-002				\$8.50
	820290	SSD 9371 Thick Door Pack		-002	-001			\$7.50
						-003		\$8.50
	820291	Thick Door Pack - Milan & Halifax		-002	-001	-003		\$7.50
	83022	GD 1471 Thick Door Pack		-002	-001	-003		\$7.50
	82213	Screw and Washer Pack					-002	\$1.40

Intro

Electronics

Box Pack

Visual Pack

Parts

**DEADBOLTS & HANDLESET  
DEADBOLTS**

MODEL

FUNCTION

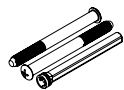

81691

All Weiser GD9471 Deadbolts and Handleset Deadbolts

820289

All Metro SSD9471 Deadbolts

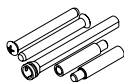

86129

All Elements GDC9471 and Handleset Deadbolts

Intro





Electronics

Box Pack

Visual Pack

**Parts**



KEY CONTROL	MODEL	FUNCTION	FINISH						QUANTITY	LIST PRICE
			3	5	11P/514	15	26D	NA		
	820205	Key Control Deadbolt Cylinder Cover				-003	-004		1	\$4.80
	83390	Key Control Deadbolt Mounting Screws			-004	-002			1	\$8.50
	83395	Key Control Deadbolt Rotation Tool						-001	1	\$7.50
	83393	Key Control Deadbolt Security Mounting Screws	-001		-004	-003	-002		1	\$4.80
	83394	Key Control Deadbolt Screw Torx Wrench						-001	1	\$7.50

Intro

Electronics





Box Pack

Visual Pack

**Parts**



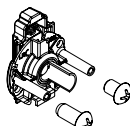
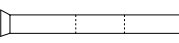

**MISCELLANEOUS**

ELECTRONICS	MODEL	FUNCTION	FINISH							LIST PRICE			
			L03	5	11P	15	15A	26	NA				
	800004-456-458	Smartcode Deadbolt Top Cover (Traditional)											\$15
	800004-459	Deadbolt and Lever Top Battery Holder										•	\$4.30

MISC. PARTS	MODEL	FUNCTION	FINISH											LIST PRICE	
			3	5	11P	15	15A	26	26D	501	502	514	N/A		
	820318-001	Deadbolt Frost Insert												•	\$13
	820314-001	Knob & Lever Frost Insert												•	\$13
	820309-001	Handleset Mechanism												•	\$21.50
	84991-001	GDC 9471 Torque Blade												•	\$4
	83273	GDC 9471 Thumb Turn	-001		-021	-020	-013	-008	-005						\$12
	81295-001	Quick-Install Mounting Plate, Collections Hancock Knob												•	\$5.50

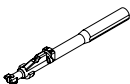
Intro  
Electronics  
Box Pack  
Visual Pack  
Parts

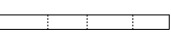
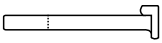
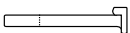
MISC. PARTS	MODEL	FUNCTION	FINISH								LIST PRICE	
			3	5	11P	15	15A	26	26D	N/A		
	87789	Reinforcing Plate, GCD 9471									-001	\$2.10
	83024	GD 1471 Interior Mounting Plate									-001	\$3.20
	82778	Inactive Cylinder, GDC 9471				-005						\$8.50
	820232	GD9471 Disabling Kit									-001	\$23.50
	81239	GCD Body Inactive Cylinder									-001	\$15
	81226	Inactive Cylinder Cover	-002	-003	-009	-004	-005	-006	-007			\$4.80
	88841	GA & GAC Privacy Knobs Interior Round Spindle									-001	\$1.40

MISC. PARTS	MODEL	FUNCTION	FINISH								LIST PRICE	
			3	5	15	15A	26	26D	TIP	NA		
	87628-001	GA Entry Interior Round Spindle									•	\$1.40
	81822	DB 2-1/8" Adapter for GCD 9471 / 9371 - GD 9471 / 9371									-001	\$5.50
	84988	1.37" Torque Blade Double Cylinder Thick Door									-001	\$3.70
	84992	2.491" Torque Blade Single Cylinder Thick Door									-001	\$3.70
	84994	1.40" Torque Blade, Thick Door									-001	\$3.70
	84993	1.097" Torque Blade, Standard Door									-001	\$3.70
	800003-547	Sample Weiser Finish Ring									•	\$27

Intro

Electronics

Box Pack

Visual Pack

Parts

**PLAIN LATCH**

ITEM #	DESCRIPTION	LIST PRICE
810000-188	Square Corner Plain Latch - 3	\$14.00
810000-185	Square Corner Plain Latch - 11P	\$14.00
810000-186	Square Corner Plain Latch - 15	\$14.00
810000-378	Square Corner Plain Latch - 15A	\$14.00
810000-187	Square Corner Plain Latch - 26D	\$14.00
810000-392	Drive-in Plain Latch - 3/11P	\$14.00
810000-189	Drive-in Plain Latch - 15/15A/26D	\$14.00
810000-184	Radius Corner Plain Latch - 3	\$14.00
810000-181	Radius Corner Plain Latch - 11P	\$14.00
810000-182	Radius Corner Plain Latch - 15	\$14.00
810000-377	Radius Corner Plain Latch - 15A	\$14.00
810000-183	Radius Corner Plain Latch - 26D	\$14.00

**DEAD LATCH**

ITEM #	DESCRIPTION	LIST PRICE
810000-179	Square Corner Dead Latch - 3	\$14.00
810000-176	Square Corner Dead Latch - 11P	\$14.00
810000-177	Square Corner Dead Latch - 15	\$14.00
810000-380	Square Corner Dead Latch - 15A	\$14.00
810000-178	Square Corner Dead Latch - 26D	\$14.00
810000-391	Drive-in Dead Latch - 3/11P	\$14.00
810000-180	Drive-in Dead Latch - 15/15A/26D	\$14.00
810000-175	Radius Corner Dead Latch - 3	\$14.00
810000-172	Radius Corner Dead Latch - 11P	\$14.00
810000-173	Radius Corner Dead Latch - 15	\$14.00
810000-379	Radius Corner Dead Latch - 15A	\$14.00
810000-174	Radius Corner Dead Latch - 26D	\$14.00

**DEADBOLT LATCH**

ITEM #	DESCRIPTION	LIST PRICE
810000-386	Square Corner Deadbolt Latch - 3	\$22.50
810000-389	Square Corner Deadbolt Latch - 11P	\$22.50
810000-387	Square Corner Deadbolt Latch - 15	\$22.50
810000-388	Square Corner Deadbolt Latch - 15A	\$22.50
810000-390	Square Corner Deadbolt Latch - 26D	\$14.00
810000-393	Drive-in Deadbolt Latch - 3/11P	\$14.00
810000-394	Drive-in Deadbolt Latch - 15/15A/26D	\$14.00
810000-381	Radius Corner Deadbolt Latch - 3	\$22.50
810000-384	Radius Corner Deadbolt Latch - 11P	\$22.50
810000-382	Radius Corner Deadbolt Latch - 15	\$22.50
810000-383	Radius Corner Deadbolt Latch - 15A	\$22.50
810000-385	Radius Corner Deadbolt Latch - 26D	\$22.50

**SCREW PACK FOR PASSAGE/PRIVACY/ENTRY LEVERS**

ITEM #	DESCRIPTION	LIST PRICE
810000-398	Lever Screw Pack - 3	\$2.10
810000-400	Lever Screw Pack - 11P	\$2.10
810000-399	Lever Screw Pack - 26	\$2.10

**SCREW PACK FOR PASSAGE/PRIVACY/ENTRY KNOBS**

ITEM #	DESCRIPTION	LIST PRICE
810000-401	Knob Screw Pack - 3	\$2.10
810000-403	Knob Screw Pack - 11P	\$2.10
810000-402	Knob Screw Pack - 26	\$2.10

### SCREW PACK FOR DUMMY LEVERS

ITEM #	DESCRIPTION	LIST PRICE
810000-395	Dummy Lever Screw Pack - 3	\$0.80
810000-397	Dummy Lever Screw Pack - 11P	\$0.80
810000-396	Dummy Lever Screw Pack - 26	\$0.80

### SCREW PACK FOR DUMMY KNOBS

ITEM #	DESCRIPTION	LIST PRICE
810000-404	Dummy Knob Screw Pack - 3	\$0.80
810000-406	Dummy Knob Screw Pack - 11P	\$0.80
810000-405	Dummy Knob Screw Pack - 26	\$0.80

### SCREW PACK FOR SINGLE CYLINDER DEADBOLT

ITEM #	DESCRIPTION	LIST PRICE
810000-410	SD9100 Screw Pack - 3	\$1.90
810000-412	SD9100 Screw Pack - 11P	\$1.90
810000-411	SD9100 Screw Pack - 26	\$1.90

### SCREW PACK FOR HANDLESET

ITEM #	DESCRIPTION	LIST PRICE
810000-419	SH1100 Screw Pack - 3	\$0.80
810000-421	SH1100 Screw Pack - 11P	\$0.80
810000-420	SH1100 Screw Pack - 26	\$0.80

### SCREW PACK FOR LEVER OF HANDLESET

ITEM #	DESCRIPTION	LIST PRICE
810000-422	SH1100 Screw Pack for Lever - 3	\$1.90
810000-424	SH1100 Screw Pack for Lever - 11P	\$1.90
810000-423	SH1100 Screw Pack for Lever - 26	\$1.90





### SCREW PACK FOR KNOB OF HANDLESET

ITEM #	DESCRIPTION	LIST PRICE
810000-425	SH1100 Screw Pack for Knob - 3	\$1.90
810000-427	SH1100 Screw Pack for Knob - 11P	\$1.90
810000-426	SH1100 Screw Pack for Knob - 26	\$1.90

### PLUG FOLLOWER

ITEM #	DESCRIPTION	LIST PRICE
810000-365	Safelock Plug Follower	\$10

Intro  
Electronics  
Box Pack  
Visual Pack  
Parts

ADJUSTABLE LATCHES	MODEL	FUNCTION	QTY	
			VP	LIST PRICE
	800004-110	Deadlocking Drive-In & Square Faceplate	1	\$18
	800000-044	Spring Drive-in and Square Faceplate	1	\$18
	820326-001	Beverly 9/26D Deadlatch	1	\$17
	820327-001	Beverly 9/26D Plainlatch	1	\$16
	820304-001	Beverly 9/26D Vestibule	1	\$17

PIN & TUMBLER	MODEL	FUNCTION	QTY	
			VP	LIST PRICE
	800000-125	Brass Keyblank, 5 Pin	1	\$2.20